

EM 1110-1-1003
1 July 2003

US Army Corps
of Engineers

ENGINEERING AND DESIGN

NAVSTAR Global Positioning System Surveying

ENGINEER MANUAL

CECW-EE

Manual
No. 1110-1-1003

1 July 2003

Engineering and Design
NAVSTAR GLOBAL POSITIONING SYSTEM SURVEYING

1. Purpose. This manual provides technical specifications and procedural guidance for surveying and mapping with the NAVSTAR Global Positioning System (GPS). It is intended for use by engineering, planning, operations, real estate, and construction personnel performing georeferenced feature mapping or accurate control surveys for civil works and military construction projects. Procedural and quality control standards are defined to establish Corps-wide uniformity in the use of GPS by hired-labor personnel, construction contractors, and Architect-Engineer (A-E) contractors.

2. Applicability. This manual applies to all USACE commands having responsibility for the planning, engineering and design, operation, maintenance, construction, and related real estate and regulatory functions of civil works, military construction, and environmental restoration projects. It applies to GPS survey performance by both hired-labor forces and contracted survey forces. It is also applicable to surveys performed or procured by local interest groups under various cooperative or cost-sharing agreements.

3. Discussion. GPS surveying is a process by which highly accurate, three-dimensional point positions are determined from signals received from satellites. GPS-derived positions may be used to provide the primary reference control monument locations for engineering and construction projects, from which detailed site plan topographic mapping, boundary demarcation, and construction alignment work may be performed using conventional surveying instruments and procedures. GPS surveying also has application in the precise positioning of marine floating plant and photogrammetric mapping aircraft, and in monitoring structural deformations of locks and dams. GPS control surveying techniques are also used for the rapid, real-time geospatial feature mapping of wetlands, facilities, utilities, and related geographical information system (GIS) products. USACE commands first began using GPS in 1983, primarily for establishing precise positions on fixed monuments to control navigation and military construction projects. In the early 1990s, commands began using dynamic GPS for real-time control of hydrographic survey vessels and dredges, and real-time topographic mapping. In the later 1990s, GPS applications expanded to precise airborne positioning for photogrammetric mapping and Light Detection and Ranging (LIDAR) terrain modeling applications. Simply operated hand-held GPS receivers using wide-area augmentation networks will now provide accurate, real-time geospatial coordinate and feature data for an expanding and unlimited number of USACE positioning and navigation applications.

FOR THE COMMANDER:

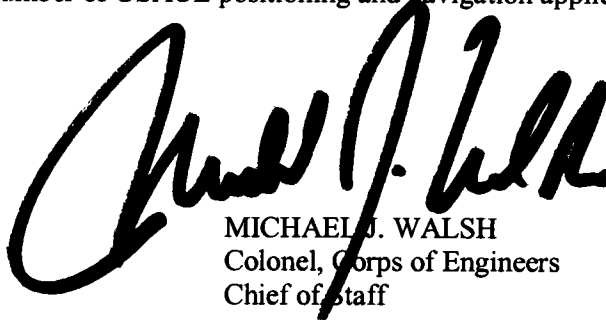

MICHAEL J. WALSH
Colonel, Corps of Engineers
Chief of Staff

10 Appendices
(See Table of Contents)

CECW-EE

Manual
No. 1110-1-1003

1 July 2003

Engineering and Design
NAVSTAR GLOBAL POSITIONING SYSTEM SURVEYING

Table of Contents

Subject	Paragraph	Page
Chapter 1		
Introduction		
Purpose	1-1	1-1
Applicability	1-2	1-1
Distribution	1-3	1-1
References	1-4	1-1
Background	1-5	1-1
Use of Manual	1-6	1-2
Scope of Manual	1-7	1-2
Life Cycle Project Management Applicability	1-8	1-3
Metrics and Accuracy Definitions	1-9	1-3
Trade Name Exclusions	1-10	1-3
Abbreviations and Terms	1-11	1-4
Mandatory Requirements	1-12	1-4
Governing Engineer Regulations and Related Standards	1-13	1-4
Proponency and Waivers	1-14	1-4
Chapter 2		
Operational Theory of NAVSTAR GPS		
General	2-1	2-1
Global Positioning System (GPS) Overview	2-2	2-1
NAVSTAR GPS Program Background	2-3	2-1
NAVSTAR System Configuration	2-4	2-2
GPS Broadcast Frequencies and Codes	2-5	2-5
GPS Broadcast Messages and Ephemeris Data	2-6	2-6
GPS Status and Problem Reporting	2-7	2-8
GPS User Operating and Tracking Modes	2-8	2-10
Absolute GPS Positioning Techniques	2-9	2-10
Differential or Relative GPS Positioning Techniques	2-10	2-11
NAVSTAR GPS Modernization Initiatives (2003-2014)	2-11	2-11

Subject	Paragraph	Page
---------	-----------	------

Chapter 3
GPS Reference Systems

General	3-1	3-1
Geodetic Coordinate Systems.....	3-2	3-1
WGS 84 Reference Ellipsoid.....	3-3	3-2
Horizontal Datums and Reference Frames.....	3-4	3-2
Transforming between Horizontal Survey Datums	3-5	3-5
Orthometric Elevations.....	3-6	3-7
WGS 84 Ellipsoidal Heights	3-7	3-9
Orthometric Height and WGS 84 Ellipsoidal Elevation Relationship	3-8	3-9
Geoid Undulations and Geoid Models	3-9	3-10
North American Vertical Datum of 1988 (NAVD 88).....	3-10	3-11
Using GPS to Densify Orthometric Elevations	3-11	3-12
GPS Vertical Site Calibration.....	3-12	3-13
GPS Time References.....	3-13	3-15

Chapter 4
GPS Absolute Positioning Determination Concepts, Errors, and Accuracies

General	4-1	4-1
Absolute Point Positioning.....	4-2	4-1
GPS Absolute Position Solution Process--Pseudorangeing	4-3	4-2
GPS Point Positioning Accuracies	4-4	4-4
Positional Accuracy Statistics--Root Mean Square.....	4-5	4-5
GPS Range Error Budget.....	4-6	4-7
User Equivalent Range Error.....	4-7	4-11
Satellite Geometry Effects on Accuracy--Geometrical Dilution of Precision.....	4-8	4-12
Resultant Positional Accuracy of Point Positioning.....	4-9	4-14

Chapter 5
Differential or Relative Positioning Determination Concepts

General	5-1	5-1
Differential Positioning Concepts	5-2	5-1
Differential Positioning (Code Pseudorange Tracking)	5-3	5-2
Differential Positioning (Carrier Phase Tracking).....	5-4	5-4
Carrier Phase Survey Techniques.....	5-5	5-5
Real-time Kinematic (RTK) GPS.....	5-6	5-7
Differential GPS Error Sources	5-7	5-8
Differential GPS Accuracies	5-8	5-9
Differential GPS Augmentation Systems	5-9	5-11

Chapter 6
GPS Applications in USACE

General	6-1	6-1
Project Control Densification.....	6-2	6-3
Facility Site Plan Topographic Mapping and GIS Surveys	6-3	6-4

Subject	Paragraph	Page
Shallow Wetland Mapping	6-4	6-5
Flood Control Projects--Levee Assessments	6-5	6-6
Navigation Project Survey Vessel and Dredge Control	6-6	6-6
Hydraulic and Hydrology Studies	6-7	6-8
Structural Deformation Surveys	6-8	6-9
Construction Stakeout and Grading.....	6-9	6-10
Coastal Engineering Surveys.....	6-10	6-10
Photogrammetric Mapping Control.....	6-11	6-11

Chapter 7
GPS Receiver and Equipment Selection

General	7-1	7-1
Types of GPS Receivers.....	7-2	7-1
GPS Receiver Selection Considerations.....	7-3	7-2
Military Grade GPS Receivers	7-4	7-5
GPS Receiver Manufacturers	7-5	7-6
Other Auxiliary Equipment	7-6	7-7
Resource Grade GIS Mapping Receivers.....	7-7	7-8
Common Data Exchange Formats.....	7-8	7-10
GPS Training and Operation Manuals.....	7-9	7-13
Guide Specifications for Procuring Geodetic Quality GPS Receivers	7-10	7-13

Chapter 8
Planning Data Collection with GPS

Scope	8-1	8-1
General Planning Considerations for GPS Surveys	8-2	8-1
Project Control Function and Accuracy	8-3	8-2
Selection of a GPS Survey Technique.....	8-4	8-8
Planning Differential Code Phase GPS Surveys	8-5	8-9
Field Reconnaissance for GPS Surveys.....	8-6	8-10
Technical Criteria for Carrier Phase GPS Horizontal Control Surveys.....	8-7	8-18
Recommended Static Baseline Occupation Times for		
Horizontal Control Surveys	8-8	8-23
Network Design and Layout for Carrier Phase GPS Horizontal Control Surveys ...	8-9	8-24
Planning Vertical Control Surveys using Carrier Phase GPS	8-10	8-29
Technical Criteria for GPS Vertical Densification.....	8-11	8-30
Orthometric Elevation Guidelines	8-12	8-30
Additional Guidelines and Recommendations for		
Planning GPS Vertical Densification	8-13	8-33
Cadastral Survey Standards and Guidelines using GPS	8-14	8-35
Field Planning Considerations for GPS Surveys.....	8-15	8-36
Mandatory Criteria	8-16	8-38

Subject	Paragraph	Page
Chapter 9		
Conducting GPS Field Surveys		
General	9-1	9-1
General GPS Field Survey Procedures	9-2	9-1
Section I--Conducting Absolute GPS Positioning and Navigation Surveys		
General	9-3	9-12
Absolute Point Positioning Techniques.....	9-4	9-12
Absolute GPS Navigation Systems	9-5	9-12
Mapping Grade GPS Receivers.....	9-6	9-13
Section II: Conducting Differential GPS Code Phase Positioning and Mapping Surveys		
General	9-7	9-15
USCG DGPS Radiobeacon Navigation Service.....	9-8	9-15
FAA Wide Area Augmentation System (WAAS).....	9-9	9-18
FAA Local Area Augmentation System (LAAS).....	9-10	9-20
OmniSTAR Wide-Area Differential Positioning Service	9-11	9-21
LandStar Differential GPS Service (Thales)	9-12	9-23
Code and Carrier Phase Wide Area Augmentation Services.....	9-13	9-24
Section III: Conducting Differential GPS Carrier Phase Surveys		
General	9-14	9-25
Ambiguity Resolution	9-15	9-25
Static Carrier Phase Field Survey Techniques	9-16	9-26
Rapid/Fast Static Surveying Procedures.....	9-17	9-27
Kinematic GPS Survey Techniques	9-18	9-29
Stop-and-Go Kinematic Field Survey Techniques.....	9-19	9-29
Pseudo-Kinematic Field Survey Techniques.....	9-20	9-31
Real-Time Kinematic (RTK) Field Surveying Techniques.....	9-21	9-32
RTK Survey Field Procedures and Calibrations.....	9-22	9-34
Chapter 10		
Post-Processing Differential GPS Observational Data		
General	10-1	10-1
General Differential Reduction Techniques	10-2	10-1
Carrier Phase Observables.....	10-3	10-2
Baseline Solution by Linear Combination.....	10-4	10-2
Baseline Solution by Cycle Ambiguity Recovery.....	10-5	10-5
Field/Office Baseline Processing.....	10-6	10-6
Resultant Baseline Output and Quality Criteria	10-7	10-8
Examples of Baseline Reduction Software Output	10-8	10-12
Baseline Reduction Summaries	10-9	10-17
Baseline Reduction in Mapping Grade GPS Receivers.....	10-10	10-19
Field/Office Loop Closure Checks	10-11	10-20
On-Line Positioning User Service (OPUS).....	10-12	10-23
Scripps Coordinate Update Tool (SCOUT).....	10-13	10-28
Automated GIPSY Analyses (Jet Propulsion Laboratory).....	10-14	10-29
Baseline Data Management and Archival	10-15	10-29

Subject	Paragraph	Page
Chapter 11		
Adjustment of GPS Surveys		
General	11-1	11-1
Adjustment Considerations	11-2	11-1
GPS Error Measurement Statistics	11-3	11-2
Survey Adjustments and Accuracy	11-4	11-4
Free or Minimally Constrained Adjustments	11-5	11-7
Fully Constrained Adjustments	11-6	11-8
Partially Constrained Adjustments	11-7	11-10
Rigorous Least Squares Adjustments of GPS Surveys	11-8	11-11
Network Adjustment Software Used in Corps	11-9	11-12
Network Adjustment Criteria	11-10	11-13
Baseline Weights--Covariance Matrix	11-11	11-14
Adjustment Output Statistics	11-12	11-16
Minimally Constrained Adjustment Considerations	11-13	11-16
Relative Baseline Accuracy Estimates	11-14	11-17
Normalized or Standardized Residuals.....	11-15	11-18
Outlier Tests and Reject Criteria	11-16	11-19
Positional Accuracy Statistics and Error Ellipses.....	11-17	11-21
Sample GPSurvey Network Adjustment--San Juan PR Flood Control Project.....	11-18	11-24
Sample Network Adjustment--Virginia Key, FL Disposal Area Site	11-19	11-29
Sample Network Adjustment--Everglades National Park Modified Water Deliveries	11-20	11-36
Approximate Adjustments of GPS Networks.....	11-21	11-43
Geocentric Coordinate Conversions.....	11-22	11-49
Evaluation of Adjustment Results	11-23	11-52
Final Adjustment Reports, Submittals, and Metadata	11-24	11-53
Mandatory Requirements	11-25	11-59
Chapter 12		
Contracting GPS Surveying Services		
General	12-1	12-1
Brooks Architect-Engineer Act`	12-2	12-1
Contracting Processes and Procedures	12-3	12-1
Indefinite Delivery Contracts and Task Orders	12-4	12-2
Contract Price Schedule	12-5	12-3
Sample Cost Estimate for Contracted GPS Survey Services.....	12-6	12-5
Cost Per Work Unit (GPS Station) Schedule	12-7	12-6
Contract Specifications and Accuracy Standards.....	12-8	12-6
Contract Statements of Work	12-9	12-7
Contract Quality Control and Quality Assurance.....	12-10	12-7
Task Order Time and Cost Estimates	12-11	12-7
Sample Task Order for GPS Services.....	12-12	12-8

Appendix A References

Appendix B Abbreviations and Acronyms

Appendix C Contract Schedules for GPS Surveying Services

Appendix D Application: Dredge Material Disposal Area RTK Cross-Sections
(Jacksonville District)

Appendix E Application: Photogrammetric Mapping Control Surveys of Nine Mile Run
(Pittsburgh District)

Appendix F Application: Static GPS Control Survey--Coyote Dam, Russian River, CA
(Sacramento District)

Appendix G Application: Structural Deformation Reference Network Survey--Dworshak
Dam, Idaho (Walla Walla District and Topographic Engineer Center)

Appendix H Application: Upper Saginaw River, MI Navigation Project--Second-Order
GPS Photo Mapping Control Surveys (Detroit District)

Appendix I Application: Rio Guamani, Puerto Rico Section 205 Flood Control Project--
GPS Horizontal and Vertical Control Densification (Jacksonville District)

Appendix J Application: Upland Disposal Area GPS Control Survey--Manatee Harbor,
FL (Jacksonville District)

Glossary

Chapter 1 Introduction

1-1. Purpose

This manual provides technical specifications and procedural guidance for surveying and mapping with the NAVSTAR Global Positioning System (GPS). It is intended for use by engineering, planning, operations, real estate, and construction personnel performing georeferenced feature mapping or accurate control surveys for civil works and military construction projects. Procedural and quality control standards are defined to establish Corps-wide uniformity in the use of GPS by hired-labor personnel, construction contractors, and Architect-Engineer (A-E) contractors.

1-2. Applicability

This manual applies to all USACE commands having responsibility for the planning, engineering and design, operation, maintenance, construction, and related real estate and regulatory functions of civil works, military construction, and environmental restoration projects. It applies to GPS survey performance by both hired-labor forces and contracted survey forces. It is also applicable to surveys performed or procured by local interest groups under various cooperative or cost-sharing agreements.

1-3. Distribution

This publication is approved for public release; distribution is unlimited.

1-4. References

Referenced USACE publications and related bibliographic information are listed in Appendix A. Where applicable, primary source material for individual chapters may also be noted within that chapter. Up to date information on GPS systems, processes, equipment, and vendors may be obtained through the US Army Topographic Engineering Center's GPS web site: http://www.tec.army.mil/info_links.html

1-5. Background

GPS surveying is a process by which highly accurate, three-dimensional point positions are determined from signals received from satellites. GPS-derived positions may be used to provide the primary reference control monument locations for engineering and construction projects, from which detailed site plan topographic mapping, boundary demarcation, and construction alignment work may be performed using conventional surveying instruments and procedures. GPS surveying also has application in the precise positioning of marine floating plant and photogrammetric mapping aircraft, and in monitoring structural deformations of locks and dams. GPS control surveying techniques are also used for the rapid, real-time geospatial feature mapping of wetlands, facilities, utilities, and related geographical information system (GIS) products. USACE commands first began using GPS in 1983, primarily for establishing precise positions on fixed monuments to control navigation and military construction projects. In the early 1990s, commands began using dynamic GPS for real-time control of hydrographic survey vessels and dredges, and real-time topographic mapping. In the later 1990s, GPS applications expanded to precise airborne positioning for photogrammetric mapping and Light Detection and Ranging (LIDAR) terrain modeling applications. Simply operated hand-held GPS receivers using wide-area augmentation networks will now provide accurate, real-time geospatial coordinate and feature data for an expanding and unlimited number of USACE positioning and navigation applications.

1-6. Use of Manual

This manual is intended to be a USACE reference guide for a variety of GPS applications, including: precise control surveying, topographic site plan mapping, GIS feature mapping, positioning, and navigation. These activities may be performed by hired-labor forces, contracted forces, or combinations thereof. It is also used as the primary reference manual for Proponent Sponsored Engineer Corps Training (PROSPECT) courses on GPS surveying. General planning criteria, field and office execution procedures, and required accuracy specifications for performing GPS surveys in support of USACE engineering, construction, operations, planning, and real estate activities are provided. Accuracy specifications, procedural criteria, and quality control requirements contained in this manual shall be directly referenced in the scopes of work for Architect-Engineer (A-E) survey services or other third-party survey services. This is intended to assure that uniform and standardized procedures are followed by both hired-labor and contract service sources throughout USACE. Throughout the manual, recommended GPS surveying and mapping criteria are normally summarized in tables. Technical or procedural guidance is in more general terms where methodologies are described in readily available references or in GPS instrumentation and software operating manuals. Where procedural guidance is otherwise unavailable from industry sources, it is provided herein.

1-7. Scope of Manual

The original version of this manual was developed in the late 1980s and published on 14 June 1991 by the USACE Engineer Topographic Laboratory at Fort Belvoir (now the Topographic Engineering Center under the Engineer Research and Development Center--ERDC). The 1991 version was subsequently revised on 31 December 1994 and 1 August 1996. These original versions contained detailed GPS theory, operational instructions, procedures, and equipment procurement guidance, and were based on the technology and observational methods that were still evolving during that period. Since GPS theory and observational methods are now covered in various DoD technical documents, academic publications, and/or GPS equipment manufacturer's manuals, the current update is more focused on specific USACE project applications, accuracy standards, observation criteria, and adjustment analysis.

a. General coverage. This update to the manual primarily focuses on the use of static and kinematic differential carrier phase GPS survey techniques for establishing and/or extending project horizontal and vertical construction control, boundary control, and topographic site plan mapping. Both static and kinematic control survey methods are covered, along with related GPS data reduction, post-processing, and adjustment methods. Absolute GPS point positioning methods (i.e. non-differential) and code-phase differential navigation positioning from wide-area augmentation networks are covered to a lesser extent since these techniques are not normally employed for establishing high-accuracy control coordinates on project reference monuments. These techniques do, however, have an expanding application on many USACE surveying and GIS feature mapping projects. Dynamic differential code/carrier-phase GPS positioning methods supporting hydrographic surveying and dredge control are also covered in EM 1110-2-1003 (Hydrographic Surveying). Airborne mapping and LIDAR applications of GPS are covered more fully in EM 1110-1-1000 (Photogrammetric Mapping). High-precision uses of GPS for monitoring structural deformations are more thoroughly described in EM 1110-2-1009 (Structural Deformation Surveying).

b. Manual coverage and appendices. The first few chapters in this manual are intended to provide a general overview of the theory and physical concepts of satellite GPS positioning, including coordinate systems and reference datums. Subsequent chapters cover GPS survey planning, data acquisition, data processing, and data adjustment and analysis. The final chapter on estimating costs for GPS surveys is intended to assist those USACE commands that contract out these services. The appendices to this manual contain detailed examples of GPS surveys covering a variety of Corps

projects--both civil and military. Users should be aware that these sample applications are only representative of current (2003) GPS applications and accuracies. For further information on GPS, and to stay abreast of this continuously changing technology, users of this manual should periodically consult the related publications, governmental agencies, and the Internet web site listed in paragraph 1-4 above.

c. Evolving GPS technology and procedures. Equipment operation, calibration, and procedural methods for acquiring, logging, processing, and adjusting GPS survey data are usually adequately detailed in operation manuals provided by the various GPS equipment manufacturers and geodetic adjustment software vendors. Since many of the receiver operation and data processing methods are unique to each vendor, and are being constantly updated, this manual can only provide a general overview of some of the more common techniques used by the Corps or its contractors. References and recommendations in this manual of any specific operational or adjustment methods must be carefully weighed against newly evolving technology and the latest manufacturer's recommendations. Other Corps regulations may dictate mandatory requirements for processing, displaying, transferring, and archiving GPS survey data--e.g., Metadata archiving. These mandatory regulations will be referenced where applicable. As new GPS survey instruments, technology, and procedures are developed, Districts are strongly encouraged to use those innovations and recommend modifications to any criteria or technical guidance contained in this manual--see Proponency and Waivers section at the end of this chapter.

1-8. Life Cycle Project Management Applicability

Project control established by GPS survey methods may be used through the entire life cycle of a project, spanning decades in many cases. During initial reconnaissance surveys of a project, control established by GPS should be permanently monumented and situated in areas that are conducive to the performance or densification of subsequent surveys for contract plans and specifications, construction, and maintenance. During the early planning phases of a project, a comprehensive survey control plan should be developed which considers survey requirements over a project's life cycle, with a goal of eliminating duplicative or redundant surveys to the maximum extent possible.

1-9. Metrics and Accuracy Definitions

Metric units are used in this manual. Metric units are commonly used in geodetic surveying applications, including the GPS survey work covered in this manual. GPS-derived geographical or metric Cartesian coordinates are generally transformed to English units of measurements for use in local project reference and design systems, such as State Plane Coordinate System (SPCS) grids. In all cases, the use of metric units shall follow local engineering and construction practices. English/metric equivalencies are noted where applicable, including the critical--and often statutory--distinction between the US Survey Foot (1,200/3,937 meters (m) exactly) and International Foot (30.48/100 m exactly) conversions. One-dimensional (1-D), two-dimensional (2-D), and three-dimensional (3-D) accuracy statistics, standards, and tolerances specified in this manual are defined at the 95% RMS confidence level. Unless otherwise stated, GPS "positional accuracies" imply horizontal (2-D) RMS measures. The generic term "meter-level GPS" generally refers to 2-D accuracies ranging between 0.5 m and 5 m. Likewise, "centimeter-level GPS" typically refers to 1-D, 2-D, or 3-D GPS accuracies ranging between 1 cm and 10 cm.

1-10. Trade Name Exclusions

The citation or illustration in this manual of trade names of commercially available GPS products, including other auxiliary surveying equipment, instrumentation, and adjustment software, does not constitute official endorsement or approval of the use of such products.

1-11. Abbreviations and Terms

Abbreviations and acronyms are listed at Appendix B. GPS surveying terms used in this manual are explained in the Glossary at the end of this manual.

1-12. Mandatory Requirements

ER 1110-2-1150 (Engineering and Design for Civil Works Projects) prescribes that mandatory requirements be identified in engineer manuals. Mandatory accuracy standards, quality control, and quality assurance criteria are normally summarized in tables within each chapter, and these requirements are summarized at the end of the chapter. If no mandatory requirements are listed, then the material in a particular chapter is considered recommended guidance. The mandatory criteria contained in this manual are based on the following considerations: (1) project safety assurance, (2) overall project function, (3) previous Corps experience and practice, (4) Corps-wide geospatial data standardization requirements, (5) adverse economic impacts if criteria are not followed, and (6) HQUSACE commitments to industry standards.

1-13. Governing Engineer Regulations and Related Standards

Spatial coordinates established using GPS techniques fall under the definition of geospatial data contained in ER 1110-1-8156 (Policies, Guidance, and Requirements for Geospatial Data and Systems). Accordingly, the guidance in ER 1110-1-8156, and its implementing manual EM 1110-1-2909 (Geospatial Data and Systems), must be followed for disseminating and archiving GPS-derived data. This would include preparing appropriate metadata files in accordance with the guidance in EM 1110-1-2909. Federal standards for reporting survey accuracy, geodetic control survey standards, and topographic survey standards are published by the Federal Geographic Data Committee (FGDC). These FGDC "Geospatial Positioning Accuracy Standards" are listed in Appendix A. USACE commands shall comply with these FGDC standards. This manual also references a number of Corps technical manuals listed in Appendix A. These referenced manuals contain guidance relating to performing GPS surveys for more specific applications.

1-14. Proponency and Waivers

The HQUSACE proponent for this manual is the Engineering and Construction Division, Directorate of Civil Works. Technical development and compilation of the manual was coordinated by the US Army Topographic Engineering Center (CEERD-TR-A). Comments, recommended changes, or waivers to this manual should be forwarded through MSC to HQUSACE (ATTN: CECW-EE).

Chapter 2 Operational Theory of GPS

2-1. General

This chapter provides a general overview of the basic operating principles and theory of the NAVSTAR GPS. Much of the material is synopsised from the following references: *NAVSTAR GPS User Equipment Introduction* (DoD 1996) and the *Global Positioning System Standard Positioning Service Performance Standard* (DoD 2001). These two sources, along with other references listed in Appendix A, should be consulted for more detailed coverage on all the topics covered in this chapter.

2-2. Global Positioning System (GPS) Overview

GPS is a passive, all-weather, 24-hour global navigation satellite system (GNSS) operated and maintained by the Department of Defense (DoD). It consists of a nominal constellation of 24 satellites in high-altitude orbits. Its primary mission is to provide passive, real-time, 3-D positioning, navigation and velocity data for land, air, and sea-based strategic and tactical forces operating anywhere in the world. A secondary--and most predominant--application is a wide range of civil positioning and time transfer. A ground-based static or roving GPS receiver is simply a range measurement device: distances are measured between the receiver antenna and four to ten satellites in view, and the position is determined from the adjusted intersections of the range vectors--equivalent to a trilateration solution in terrestrial surveying. These distances are determined in the GPS receiver by precisely measuring the time it takes a coded signal to travel from the satellites to the receiver antenna. The critical components in the system are the precisely synchronized atomic clocks in the satellites. In addition, many GPS receivers can also measure the phase difference of the satellite signal's 19 and 24 cm carrier waves, allowing for sub-centimeter distance resolution of the range to the satellite. This phase resolution measurement process is similar to that used in conventional electronic distance measurement (EDM) land surveying equipment.

2-3. NAVSTAR GPS Program Background

A direct product of the "space race" of the 1960's, the GPS is actually the result of the merging of two independent programs that were begun in the early 1960's: the US Navy's TIMATION Program and the US Air Force's 621B Project. Another system similar in basic concept to the current GPS was the US Navy's TRANSIT program, which was also developed in the 1960's. Currently, the entire system is maintained by the US Air Force NAVSTAR GPS Joint Program Office (JPO), a North Atlantic Treaty Organization (NATO) multi-service type organization that was established in 1973. DoD initially designed the GPS for military use only, providing sea, air, and ground troops of the United States and members of NATO with a unified, high-precision, all-weather, worldwide, real-time positioning system. The first US pronouncement regarding civil use of GPS came in 1983 following the downing of Korean Airlines Flight 007 after it strayed over territory belonging to the Soviet Union. As a result of this incident, in 1984, President Reagan announced the Global Positioning System would be made available for international civil use once the system became operational. In 1987, DoD formally requested the Department of Transportation (DoT) to establish and provide an office to respond to civil users' needs and to work closely with the DoD to ensure proper implementation of GPS for civil use. Two years later, the US Coast Guard became the lead agency for this project. On December 8, 1993, the DoD and DoT formally declared Initial Operational Capability (IOC), meaning that the NAVSTAR GPS was capable of sustaining the Standard Positioning Service (SPS). On April 27, 1995, the US Air Force Space Command formally declared GPS met the requirements for Full Operational Capability (FOC), meaning that the constellation of 24 operational satellites had successfully completed testing for military capability. Mandated by Congress, GPS is freely used by both the military and civilian public for real-time absolute

positioning of ships, aircraft, and land vehicles, as well as highly precise differential point positioning and time transferring.

2-4. NAVSTAR System Configuration

The NAVSTAR GPS consists of three distinct segments: the space segment (satellites), the control segment (ground tracking and monitoring stations), and the user segment (air, land, and sea-based receivers). See Figure 2-1 for a representation of the basic GPS system segments.

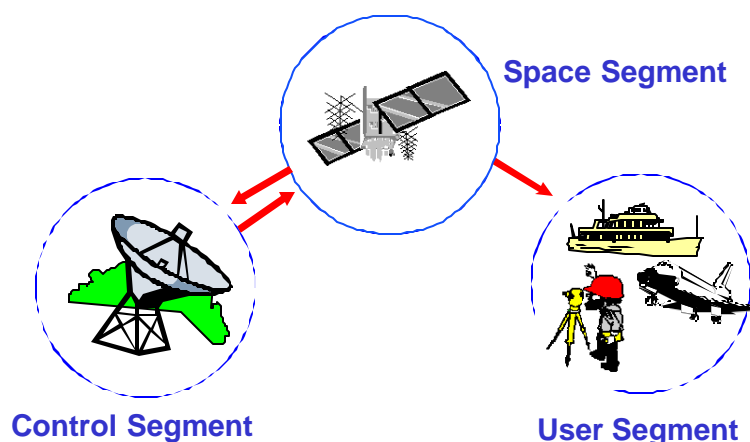

Figure 2-1. NAVSTAR GPS System Segments

a. Space segment. The space segment consists of all GPS satellites in orbit. The initial space segment was designed with four satellites in each of six orbital planes inclined at 55 degrees to the equator. The actual number of operational satellites and their locations varies at any given time as satellites are constantly being replaced, realigned, and upgraded--see Table 2-1. The average life of a GPS satellite is approximately eight years. For example, Table 2-1 indicates 29 functioning satellites on the date shown. The satellites are located at average altitudes of 20,200 km (10,900 nautical miles), and have 11-hour 58-minute orbital periods. They are positioned in orbit such that at least four geometrically suitable satellites will be available for navigation. The first generation of satellites launched between 1978 and 1985 were the Block I (research and development). None of these are still operational. The second series of launches (the Block II or production satellites--Figure 2-2) was begun in 1989. The GPS constellation was declared fully operational in 1995 (prior to this time, GPS positioning was intermittent due to lack of full coverage). Launching of Block IIR (R is for replenishment) satellites began in 1997 and is still underway. Future launches of a Block IIF (Follow-on) series, along with related GPS modernization initiatives (i.e. GPS III), will keep the system operational for at least the next two decades. NAVSTAR GPS is not the only global navigation satellite system (GNSS). Russia maintains a similar global orbiting satellite navigation system (GLONASS) of nominally 24 satellites. Some high-end receivers can acquire and process both the GPS and GLONASS satellites simultaneously. This capability will be further expanded when the proposed European Union 30-satellite navigation system (GALILEO) is implemented in a decade or so. Japan and China are also considering development of their own GNSS. The ability to track more "satellites-in-view" from different GNSS enhances the accuracy and reliability of the observations.

Table 2-1. Satellite Constellation Status Report (5 May 2002)
Source: US Coast Guard Navigation Center (www.navcen.uscg.gov)

SVN No	PRN No	Block-Mission No	Launch Date	Slot	Operational Date	Months Operat'al	Years Operat'al	IRON No
1	4	I-1	22-Feb-78	**	29-Mar-78	21.9	1.825000	5111
2	7	I-2	13-May-78	**	14-Jul-78	25.5	2.125000	5112
3	6	I-3	06-Oct-78	**	09-Nov-78	161.3	13.441667	5113
4	8	I-4	11-Dec-78	**	08-Jan-79	93.6	7.800000	5114
5	5	I-5	09-Feb-80	**	27-Feb-80	45	3.750000	5117
6	9	I-6	26-Apr-80	**	16-May-80	126.8	10.566667	5118
7	**	I-7	18-Dec-81	**	**	0	0.000000	5115
8	11	I-8	14-Jul-83	**	10-Aug-83	116.8	9.733333	9794
9	13	I-9	13-Jun-84	**	19-Jul-84	115.2	9.600000	9521
10	12	I-10	08-Sep-84	**	03-Oct-84	133.5	11.125000	9783
11	3	I-11	09-Oct-85	**	30-Oct-85	99.9	11.783333	6374
14	14	II-1	14-Feb-89	**	14-Apr-89	141.4	11.783333	6142
13	2	II-2	10-Jun-89	B3	12-Jul-89	138.6	11.550000	2567
16	16	II-3	17-Aug-89	**	13-Sep-89	136.4	11.366667	6738
19	19	II-4	21-Oct-89	A5	14-Nov-89	134.5	11.208333	2272
17	17	II-5	11-Dec-89	D3	11-Jan-90	132.6	11.050000	4373
18	18	II-6	24-Jan-90	**	14-Feb-90	127.5	10.625000	3028
20	20	II-7	25-Mar-90	**	19-Apr-90	72.7	6.058333	3310
21	21	II-8	02-Aug-90	E2	31-Aug-90	125	10.416667	470
15	15	II-9	01-Oct-90	D5	20-Oct-90	123.3	10.275000	8639
23	23	II-10	26-Nov-90	E4	10-Dec-90	121.6	10.133333	8896
24	24	II-11	03-Jul-91	D1	30-Aug-91	113	9.416667	5681
25	25	II-12	23-Feb-92	A2	24-Mar-92	106.2	8.850000	1920
28	28	II-13	09-Apr-92	**	25-Apr-92	101.1	8.425000	2941
26	26	II-14	07-Jul-92	F2	23-Jul-92	102.2	8.516667	3055
27	27	II-15	09-Sep-92	A4	30-Sep-92	100	8.333333	2524
32	1	II-16	22-Nov-92	F4	11-Dec-92	97.6	8.133333	6809
29	29	II-17	18-Dec-92	F5	05-Jan-93	96.8	8.066667	3659
22	22	II-18	02-Feb-93	B1	04-Apr-93	93.8	7.816667	8800
31	31	II-19	30-Mar-93	C3	13-Apr-93	93.5	7.791667	4780
37	7	II-20	13-May-93	C4	12-Jun-93	91.6	7.633333	5689
39	9	II-21	26-Jun-93	A1	21-Jul-93	90.3	7.525000	9631
35	5	II-22	30-Aug-93	B4	20-Sep-93	88.3	7.358333	7948
34	4	II-23	26-Oct-93	D4	01-Dec-93	85.9	7.158333	9802
36	6	II-24	10-Mar-94	C1	28-Mar-94	82	6.833333	4715
33	3	II-25	28-Mar-96	C2	09-Apr-96	57.7	4.808333	3365
40	10	II-26	16-Jul-96	E3	15-Aug-96	53.5	4.458333	8006
30	30	II-27	12-Sep-96	B2	01-Oct-96	51.9	4.325000	3320
38	8	II-28	06-Nov-97	A3	18-Dec-97	37.4	3.116667	3722
42	12	IIR-1	17-Jan-97	**	**	0	0.000000	**
43	13	IIR-2	22-Jul-97	F3	31-Jan-98	36	3.000000	8456
46	11	IIR-3	06-Oct-99	D2	03-Jan-00	12.9	1.075000	1597
51	20	IIR-4	10-May-00	E1	01-Jun-00	7.9	0.658333	1436
44	28	IIR-5	16-Jul-00	B5	17-Aug-00	5.40	0.450000	443
41	14	IIR-6	10-Nov-00	F1	10-Dec-00	1.60	0.133333	1423
54	18	IIR-7	30-Jan-01	E4	15-Feb-01	--	---	---

Note: Obtain current satellite constellation reports from the US Coast Guard Navigation Center web site



Figure 2-2. NAVSTAR GPS Block IIA Satellite

b. Control segment. The GPS control segment consists of Master Control Stations and six monitoring stations located throughout the world (Figure 2-3). The Master Control Station is located at Schriever Air Force Base, Colorado with a backup station in Gaithersburg, Maryland. The information obtained from the monitoring stations that track the satellites is used in controlling the satellites and predicting their orbits. All data from the tracking stations are transmitted to the Master Control Station where it is processed and analyzed. Ephemerides, clock corrections, and other message data are then transmitted back to the monitoring stations with ground antennas for subsequent transmittal back to the satellites. The Master Control Station is also responsible for the daily management and control of the GPS satellites and the overall control segment.

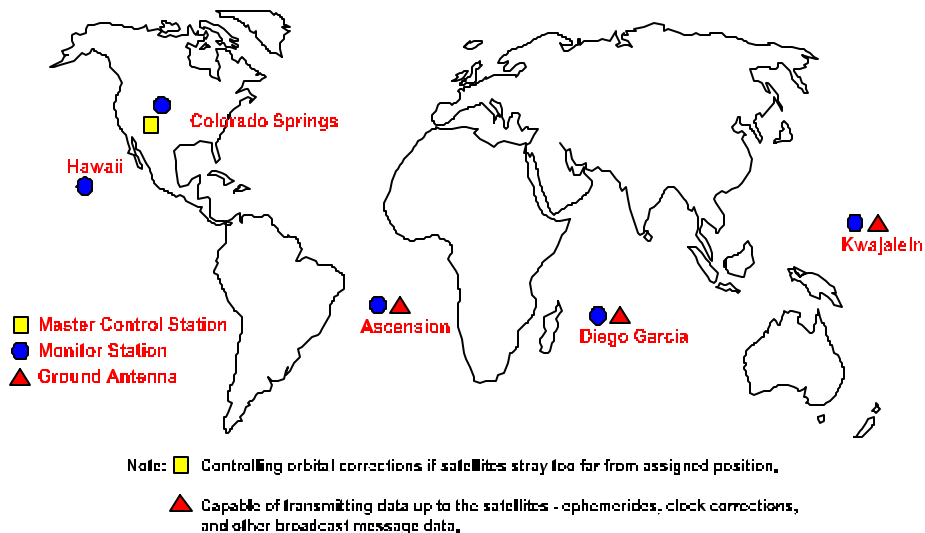

Figure 2-3. GPS Control Station Network (1994)

c. User segment. The user segment represents the ground-based GPS receiver units that process the NAVSTAR satellite signals and compute the position and/or velocity of the user. Most GPS receivers perform these functions automatically, in real-time, and often provide visual and/or verbal positional guidance information. Users consist of both military and civil activities, for an almost unlimited number of applications in a variety of air, sea, or land-based platforms. Geodetic surveying applications represent a small percentage of current and potential GPS users. Typical user receivers are shown in Figure 2-4.



Figure 2-4. Hand-held GPS receiver (PLGR) for general navigation and positioning (left) and a geodetic quality GPS receiver for precise control surveying (right)

2-5. GPS Broadcast Frequencies and Codes

Each NAVSTAR satellite transmits ranging signals on two L-band frequencies, designated as L1 and L2. The L1 carrier frequency is 1575.42 megahertz (MHz) and has a wavelength of approximately 19 centimeters (cm). The L2 carrier frequency is 1227.60 MHz and has a wavelength of approximately 24 cm. The L1 signal is modulated with a 1.023 MHz Coarse/Acquisition Code (C/A-code) and a 10.23 MHz Precision Code (P-code). The L2 signal is modulated with only the 10.23 MHz P-code. Both codes can be used to determine the range between the user and a satellite. The P-code is normally encrypted and is available only to authorized users. When encrypted, it is termed the Y-code. Table 2-2 below summarizes the carrier frequencies and codes on a Block IIR satellite. Each satellite carries precise atomic clocks to generate the timing information needed for precise positioning. A 50 Hz navigation message is also transmitted on both the P(Y)-code and C/A-code. This message contains satellite clock bias data, satellite ephemeris data, orbital information, ionospheric signal propagation correction data, health and status of satellites, satellite almanac data for the entire constellation, and other general information.

Table 2-2. NAVSTAR GPS Signal Codes and Carrier Frequencies (Block IIR)

Carrier (L-Band)	Codes		Satellite Messages
	Civilian C/A-Code	Military P(Y)-Code	
L1 1575.42 MHz 19 cm wavelength	Present 293 m wavelength	Present 29.3 m wavelength	user messages satellite constants satellite positions
L2 1227.60 MHz 24 cm wavelength	Not Present	Present 29.3 m wavelength	

a. Pseudo-random noise. The modulated C/A-code is referred to as pseudo-random noise (PRN). This pseudo-random noise is actually a 1023 bit code with a clock rate of 1.023 MHz that repeats every 1 millisecond. The 10.23 MHz P(Y)-code PRN has a coded sequence of 267 days. This sequence of very precise time marks permits the ground receivers to compare and compute the time of transmission between the satellite and ground station. From this transmission time, the range to the satellite can be derived. This is the basis behind GPS range measurements. Each satellite has a different PRN. The C/A-code pulse intervals are approximately every 293 m in range and the more accurate P-code every 29 m-- see Table 2-2.

b. Pseudoranges. A pseudorange is the time delay between the satellite clock and the receiver clock, as determined from C/A- or P-code pulses. This time difference equates to the range measurement but is called a "pseudorange" since at the time of the measurement, the receiver clock is not synchronized to the satellite clock. In most cases, an absolute 3-D real-time navigation position can be obtained by observing at least four simultaneous pseudoranges. The Standard Positioning Service (SPS) uses the less precise L1 C/A-code pseudoranges for real-time GPS navigation. The L2 signal is not used in SPS positioning. The Precise Positioning Service (PPS) is the fundamental military real-time navigation use of GPS. Pseudoranges are obtained using the higher pulse rate (i.e. higher accuracy) P-code on both frequencies (L1 and L2). P-codes are encrypted to prevent unauthorized civil or foreign use. This encryption requires a special key.

c. Carrier phase measurements. Carrier frequency tracking measures the phase differences between the Doppler shifted satellite and receiver frequencies. Phase measurements are resolved over the relatively short L1 and L2 carrier wavelengths (19 cm and 24 cm respectively). This allows phase resolution at the mm level. The phase differences are continuously changing due to the changing satellite earth geometry. However, such effects are resolved in the receiver and subsequent data post-processing. When carrier phase measurements are observed and compared between two stations (i.e. relative or differential mode), baseline vector accuracy between the stations below the centimeter level is attainable in three dimensions. Various receiver technologies and processing techniques allow carrier phase measurements to be used in real-time centimeter positioning.

2-6. GPS Broadcast Messages and Ephemeris Data

Each NAVSTAR GPS satellite periodically broadcasts data concerning clock corrections, system/satellite status, and most critically, its position or ephemerides data. There are two basic types of ephemeris data: broadcast and precise.

a. Broadcast ephemerides. The broadcast ephemerides are actually predicted satellite positions within the navigation message that are transmitted from the satellites in real-time. The ephemerides can be acquired in real-time by a receiver capable of acquiring either the C/A or P-code. The broadcast ephemerides are computed using past tracking data of the satellites. The satellites are tracked continuously by the monitor stations to obtain more recent data to be used for the orbit predictions. This data is analyzed by the Master Control Station and new parameters for the satellite orbits are transmitted back to the satellites. This upload is performed daily with new predicted orbital elements transmitted every hour by the Navigation Message. The broadcast navigation message consists of 25 frames of data, each data frame consisting of 1,500 bits. Each frame is divided into 5 sub-frames. At the 50 Hz transmission rate, it takes six seconds to receive a sub-frame, or 12.5 minutes to receive all 25 frames of data. The following information is broadcast from the satellite to the user's GPS receiver:

- Satellite time-of-transmission
- Satellite position
- Satellite health
- Satellite clock correction
- Propagation delay effects
- Time transfer to UTC (USNO)
- Constellation status

b. Precise ephemerides. The precise ephemerides are based on actual orbital tracking data that is post-processed to obtain the more accurate satellite positions. These ephemerides are available at a later date and are more accurate than the broadcast ephemerides because they are based on actual orbital tracking data and not predicted data. The reference frame used is the International Earth Rotation Service Terrestrial Reference Frame (ITRF). NASA's International GPS Service (IGS) is the agency that coordinates the precise orbital tracking and disseminates this information to Global Data Centers for public use. In addition, an informational summary file is provided to document the computation and to convey relevant information about the observed satellites, such as maneuvers or maintenance. NOAA's National Geodetic Survey (NGS) has been designated as the Federal agency responsible for providing precise orbital ephemerides to the general public. Since the precise orbits are a combination of several orbit production centers around the globe, it does lag behind in its availability until all centers have reported in. Also, it is not made available until a full GPS week has been completed--the NGS Precise Orbits generally are available seven or eight days after the date of observation. The IGS also supplies a predicted Ultra-Rapid Orbit, which is updated twice daily, and a Rapid Orbit which is updated daily--see Table 2-3 for a summary of satellite orbital data availability. NGS provides satellite orbit positions in SP3 format every 15 minutes--in the current ITRFxx reference frame. For most USACE surveying, mapping, and navigation applications, the broadcast ephemerides are adequate to obtain the needed accuracies. For high-precision USACE control survey applications (especially vertical control densification) the final precise ephemerides should be used. Most baseline reduction software provides options for inputting precise orbital data--see Chapter 10. Details on orbital latencies, formats, and downloading instructions can be obtained at the NGS web site listed in Table 2-3.

Table 2-3. Summary of GPS Satellite Ephemerides Information (International GPS Service)

Ephemeris	Orbital Accuracy	Latency (approx)	Updates	Sample
Broadcast	260 cm	Real-time	--	daily
Predicted (Ultra-Rapid)	25 cm	Real-time	twice daily	15 min/15 min
Rapid	< 5 to 10 cm	(14 to 17 hours)	daily	15 min/5 min
Final	< 5 cm	(13 days)	weekly	15 min/5 min

Sources: International GPS Service (2002) and National Geodetic Survey <http://www.ngs.noaa.gov/GPS/GPS.html>

2-7. GPS Status and Problem Reporting

The US Coast Guard Navigation Center (NAVCEN) provides notification of changes in constellation operational status that affect the service being provided to GPS users, or if the US Government anticipates a problem in supporting performance standards established in the *GPS Standard Positioning Service Performance Standard* (DoD 2001). Through operation of the Navigation Information Service (NIS), NAVCEN provides the public with information on the GPS status. The current mechanism for accomplishing this notification is through the Notice: Advisory to Navigation Users (NANU). NANUs are a primary input in the generation of GPS-related Notice to Airmen (NOTAM) and US Coast Guard Local Notice to Mariners (LNM). In the case of a scheduled event affecting service provided to GPS users, the NIS will issue an appropriate NANU at least 48 hours prior to the event. In the case of an unscheduled outage or problem, notification will be provided as soon as possible after the event. USACE users performing high-order GPS control surveys or DGPS-controlled dredging measurement and payment surveys should closely monitor NANUs for potential problems. The NIS may be accessed through any of the following media:

Internet: <http://www.navcen.uscg.gov>

E-Mail: nisws@navcen.uscg.mil

GPS Status Recording: Telephone (703) 313-5907

WWV/WWVH Radio Broadcast or Telephone (303) 499-711:
14-15 minutes past hour (WWV) and 43-44 minutes past hour (WWVH)
Frequencies: 2.5, 5, 10, 15, and 20 MHz

Write or Call: Commanding Officer (NIS)
US Coast Guard Navigation Center
7323 Telegraph Road
Alexandria, VA 22315-3998
Telephone: (703) 313-5900

A typical GPS Status Report and a NANU disseminated by the NAVCEN is shown below. The NANU provides notice that a particular satellite (SVN 17) is unusable. GPS users can subscribe to automated receipt of these GPS Status Reports and NANUs.

UNCLASSIFIED
GPS OPERATIONAL ADVISORY 281.OA1
SUBJ: GPS STATUS 08 OCT 2002

1. SATELLITES, PLANES, AND CLOCKS (CS=CESIUM RB=RUBIDIUM):

A. BLOCK I : NONE
B. BLOCK II: PRNS 1, 2, 3, 4, 5, 6, 7, 8, 9, 10, 11, 13, 14, 15
PLANE : SLOT F4, B5, C2, D4, B4, C1, C4, A3, A1, E3, D2, F3, F1, D5
CLOCK : CS, CS, CS, RB, CS, CS, RB, RB, CS, CS, RB, RB, RB, CS
BLOCK II: PRNS 17, 18, 20, 21, 22, 23, 24, 25, 26, 27, 28, 29, 30, 31
PLANE : SLOT D3, E4, E1, E2, B1, E5, D1, A2, F2, A4, B3, F5, B2, C3
CLOCK : RB, RB, RB, CS, RB, CS, CS, CS, RB, RB, RB, RB, RB, RB

2. CURRENT ADVISORIES AND FORECASTS :

A. FORECASTS: FOR SEVEN DAYS AFTER EVENT CONCLUDES.

NANU	MSG DATE/TIME	PRN	TYPE	SUMMARY (JDAY/ZULU TIME START - STOP)
2002121	111648Z SEP 2002	22	FCSTMX	261/1100-261/2300
2002122	181306Z SEP 2002	22	FCSTSUMM	261/1123-261/1300

B. ADVISORIES:

NANU	MSG DATE/TIME	PRN	TYPE	SUMMARY (JDAY/ZULU TIME START - STOP)
2002123	251818Z SEP 2002	21	UNUSUFN	268/1830-/
2002124	070107Z OCT 2002	17	UNUSUFN	280/0110-/

C. GENERAL:

NANU	MSG DATE/TIME	PRN	TYPE	SUMMARY (JDAY/ZULU TIME START - STOP)
------	---------------	-----	------	---------------------------------------

3. REMARKS:

A. THE POINT OF CONTACT FOR GPS MILITARY OPERATIONAL SUPPORT IS THE GPS SUPPORT CENTER AT (719)567-2541 OR DSN 560-2541.

B. CIVILIAN: FOR INFORMATION, CONTACT US COAST GUARD NAVCEN AT COMMERCIAL (703)313-5900 24 HOURS DAILY AND INTERNET
[HTTP://WWW.NAVCEN.USCG.GOV](http://www.navcen.uscg.gov)

C. MILITARY SUPPORT WEBPAGES CAN BE FOUND AT THE FOLLOWING
[WWW.SCHRIEVER.AF.MIL/GPS](http://www.schriever.af.mil/gps) OR [WWW.PETERSON.AF.MIL/USSPACE/GPS_SUPPORT](http://www.peterson.af.mil/usspace/gps_support)

NOTICE ADVISORY TO NAVSTAR USERS (NANU) 2002124 SUBJ: SVN17 (PRN17) UNUSABLE JDAY 280/0110 - UNTIL FURTHER NOTICE

1. NANU NUMBER: 2002124

NANU DTG: 070107Z OCT 2002

NANU Type: UNUSUFN

REFERENCE NANU: N/A

REF NANU DTG: N/A

SVN: 17

PRN: 17

START JDAY: 280

START TIME ZULU: 0110

START CALENDER DATE: Monday, October 07, 2002

STOP JDAY: UFN

STOP TIME ZULU: N/A

STOP CALENDER DATE: N/A

2. CONDITION: GPS SATELLITE SVN17 (PRN17) WILL BE UNUSABLE ON JDAY 280 (07 OCT 2002) BEGINNING 0110 ZULU UNTIL FURTHER NOTICE. 3. POC: CIVILIAN - NAVCEN AT (703)313-5900, [HTTP://WWW.NAVCEN.USCG.GOV](http://www.navcen.uscg.gov) MILITARY - GPS Support Center, DSN 560-2541, COMM 719-567-6616, GPS@SCHRIEVER.AF.MIL, [HTTP://WWW.SCHRIEVER.AF.MIL/GPS](http://www.schriever.af.mil/gps)

2-8. GPS User Operating and Tracking Modes

There are basically two general operating modes from which GPS-derived positions can be obtained: (1) absolute positioning, and (2) differential (or relative) positioning. Within each of these two modes, range measurements to the satellites can be performed by tracking either the phase of the satellite's carrier signal or the pseudo-random noise (PRN) codes modulated on the carrier signal. In addition, GPS positioning can be performed with the receiver operating in either a static or dynamic (kinematic) environment. This variety of operational options results in a wide range of accuracy levels that may be obtained from the NAVSTAR GPS. These options are discussed in detail in subsequent chapters of this manual. Positional accuracies can range from 100 m down to the sub-centimeter level. Increased accuracies to the centimeter level usually require additional observing time; however, many dynamic applications can now provide this accuracy in real-time. Selection of a particular GPS operating and tracking mode (i.e. absolute, differential, code, carrier, static, kinematic, real-time, post-processed, and/or combinations thereof) depends on the user application, accuracy requirement, and resources. Most USACE project control survey applications typically require differential positioning using carrier phase tracking. Dredge control and hydrographic survey applications typically use meter-level accuracy differential code measurements. GIS feature mapping applications may use either differential code or carrier measurements, depending on the desired accuracy. Non-differential absolute positioning modes are adequate for lesser accuracy requirements but are rarely used for geodetic surveying applications; however, they may be used for some small-scale mapping projects. In general, the cost of a particular operating system and tracking mode will exponentially increase as a function of accuracy--e.g., a 30 m point accuracy can be obtained with a \$100 GPS receiver, meter-level accuracy for \$5,000 to \$15,000, and sub-centimeter accuracy requires differential GPS equipment (or systems) in the \$15,000 to \$50,000 range.

2-9. Absolute GPS Positioning Techniques

The most common GPS positioning technique is "absolute positioning." Most commercial hand-held GPS receivers provide absolute (i.e. non-differential) positioning, with real-time horizontal or vertical accuracies in the 10 m to 30 m range, depending on the receiver quality and numerous other factors--see *Global Positioning System Standard Positioning Service Performance Standard* (DoD 2001) for a detailed analysis of GPS positional accuracies. These receivers are typically used for real-time vehicle or vessel navigation. When operating in this passive, real-time navigation mode, ranges to GPS satellites are observed by a single receiver positioned on a point for which a position is desired. This receiver may be positioned to be stationary over a point or in motion (i.e. kinematic positioning, such as on a vehicle, aircraft, missile, or backpack).

a. GPS absolute positioning services. Two levels of absolute positioning accuracy are obtained from the GPS. These are called the (1) Standard Positioning Service and (2) Precise Positioning Service.

(1) Standard Positioning Service (SPS). The SPS is the GPS positioning service that the DoD authorizes to civil users. This service consists of the C/A-code and navigation message on the L1 signal. The L2 signal is not part of the SPS, nor is the P(Y)-code on L1. The DoD may deliberately degrade the GPS signal for national security reasons. When it is deliberately degraded, as it was prior to 2000, horizontal accuracies were in the range of 75 to 100 m. Since May 2000, when this degradation was suspended, horizontal accuracies down to the 10 to 30 m level may be achieved with a quality single frequency receiver. (DoD 2001 reports average global SPS accuracies are ≤ 13 m horizontal and ≤ 22 m vertical, with worst case accuracies ≤ 36 m horizontal and ≤ 77 m vertical). DoD degradation of the GPS signal is referred to as "Selective Availability" or S/A. DoD also implements AntiSpoofing (A/S) which will deny the SPS user the more accurate P-code. S/A and A/S will be discussed further in Chapter 4.

(2) Precise Positioning Service (PPS). Use of the PPS requires authorization by DoD to have a decryption device capable of deciphering the encrypted GPS signals. USACE is an authorized user; however, actual use of the equipment has security implications. Real-time 3-D absolute positional accuracies of better than 10 m are attainable through use of the PPS with dual-frequency receivers.

b. Applications. Absolute point positioning is suitable for many USACE surveying applications where 10 to 30 m accuracy levels are acceptable, e.g., rough reconnaissance work, general vessel navigation, wetland delineation, small-scale mapping. They are also useful for some military topographic surveying applications (e.g., artillery surveying). Typical USACE applications are summarized in Chapter 6. With certain specialized GPS receiving equipment, data processing refinements, and long-term static observations, absolute positional coordinates may be determined to accuracy levels less than a meter. Future GPS modernizations and receiver enhancements are expected to improve positional accuracies down to the 3-meter level, a level that is now only achievable with differential observations described below. Refer to Chapter 4 for more information on absolute GPS positioning techniques.

2-10. Differential or Relative GPS Positioning Techniques

Differential GPS (DGPS) positioning is simply a process of determining the relative differences in coordinates between two receiver points, each of which is simultaneously observing/measuring satellite code ranges and/or carrier phases from the NAVSTAR GPS satellite constellation. The process actually involves the measurement of the difference in ranges between the satellites and two or more ground observing points. Typically, one GPS receiver is located at a known "reference" station and the other remote or "rover" receiver is positioned (or dynamically traverses) over an unknown point that requires georeferencing. Both receivers simultaneously acquire GPS data for later computation (post-processing), or, alternatively, the reference receiver transmits data to the rover receiver for "real-time" position computation. The range measurement is performed by a phase difference comparison, using either the carrier phase or code phase. The basic principle is that the absolute positioning errors at the two receiver points will be approximately the same for a given instant in time. The resultant accuracy of these coordinate differences is at the meter level for code phase observations and at the centimeter level for carrier phase tracking. These relative coordinate differences are usually expressed as "3-D baseline vectors," which are comparable to conventional survey azimuth/distance measurements. Differential GPS positioning can be performed in either a static or dynamic (kinematic mode). Most USACE precise control surveys are performed in a static (post-processing) mode while dredge and survey boat positioning is performed dynamically in real-time--see Chapter 6 for typical applications. Detailed information on differential GPS survey techniques can be found in Chapter 5.

2-11. NAVSTAR GPS Modernization Initiatives (2003-2014)

GPS Modernization is a proposed multi-phase effort to be executed over the next 15+ years--refer to Figure 2-5. Full implementation is contingent on funding availability through the program outyears. The GPS Modernization effort focuses on improving position and timing accuracy, availability, integrity monitoring support capability, and enhancement to the control system. Additional signals are planned to enhance the ability of GPS to support civil users and provide a new military code. The first new signal will be the C/A-code on the L2 frequency (1227.60 MHz). This feature will enable dual channel civil receivers to correct for ionospheric error. A third civil signal will be added on the L5 frequency (1176.45 MHz) for use in safety-of-life applications. L5 can serve as a redundant signal to the GPS L1 frequency (1575.42 MHz) with a goal of assurance of continuity of service potentially to provide precision approach capability for aviation users. In addition, a secure and spectrally separated Military Code (M-Code) will be broadcast on the L1 and L2 frequencies enabling the next generation of military receivers to operate more fully in an electronic jamming environment. At least one satellite is planned to be operational on orbit with the new C/A on L2 and M-Code capability no later than 2003. Initial

operating capability (IOC) (18 satellites on orbit) is planned for 2008 and full operational capability (FOC) (24 satellites on orbit) is planned for 2010. At least one satellite is planned to be operational on orbit with the new L5 capability no later than 2005, with IOC planned for 2012 and FOC planned for 2014. As these system enhancements are introduced, users will be able to continue to use existing compliant receivers, as signal backward compatibility is an absolute requirement for both the military and civil user communities. Although current GPS users will be able to operate at the same, or better, levels of performance than they enjoy today, users will need to modify existing user equipment or procure new user equipment in order to take full advantage of any new signal structure enhancements. Reference also the *2001 Federal Radio Navigation Plan (FRP 2001)*.

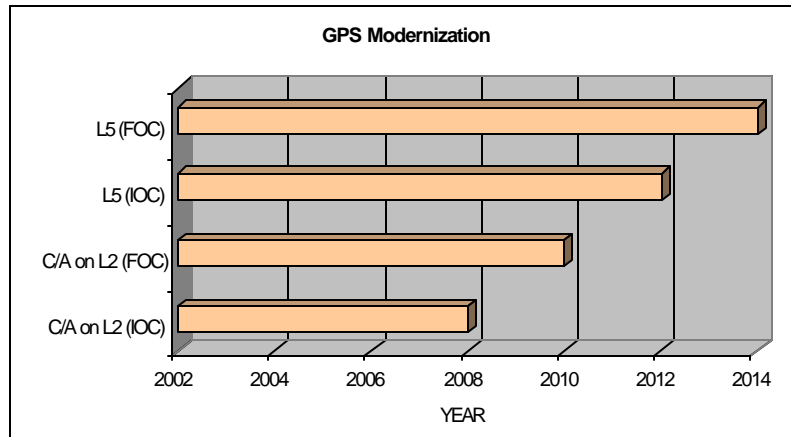

Figure 2-5. GPS Modernization Timelines

Chapter 3 GPS Reference Systems

3-1. General

In order to understand GPS and its positional information, it is important to understand the reference system on which it is based, and how that reference system relates to the user's local system. The GPS satellites are referenced to the World Geodetic System of 1984 (WGS 84) ellipsoid. For surveying purposes, this earth-centered WGS 84 coordinate system must be converted (i.e. transformed) to a user-defined ellipsoid and datum, such as the North American Datum of 1983 (NAD 83), NAD 27, the North American Vertical Datum of 1988 (NAVD 88), or the National Geodetic Vertical Datum of 1929 (NGVD 29). Differential positioning partially provides this transformation by locating one of the receivers at a known point on the user's reference datum or frame. However, for more precise applications, the reference datum cannot be considered as absolutely rigid in time. This chapter summarizes reference systems and datums to which GPS coordinates can be transformed.

3-2. Geodetic Coordinate Systems

The absolute positions obtained directly from GPS pseudorange measurements are based on the 3-D, earth-centered WGS 84 ellipsoid (Figure 3-1). Coordinate outputs are on a Cartesian system (X-Y-Z) relative to an Earth-Centered Earth-Fixed (ECEF) rectangular coordinate system having the same origin as the WGS 84 ellipsoid, i.e. geocentric. This geocentric X-Y-Z coordinate system should not be confused with the X-Y plane coordinates established on local grids; local systems usually have entirely different definitions, origins, and orientations which require certain transformations to be performed. WGS 84 geocentric X-Y-Z Cartesian coordinates can easily be converted into WGS 84 ellipsoid coordinates (i.e. f , l , and h --geodetic latitude, longitude, and ellipsoidal height, respectively). GPS baseline distances are computed on the geocentric coordinate system, not ellipsoidal coordinates. It is critical to note that the WGS 84 ellipsoidal height (h) is not the orthometric elevation used for civil works projects. Performing these transformations (also known as "site calibrations") from WGS 84 to local reference systems is a critical, and sometimes complicated, part of GPS surveying.

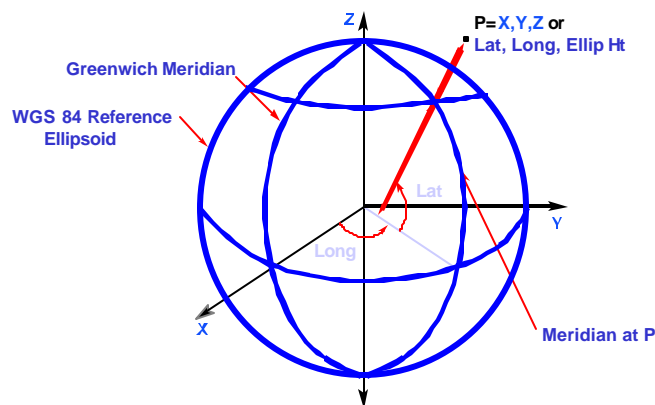

Figure 3-1. WGS 84 reference ellipsoid

3-3. WGS 84 Reference Ellipsoid

a. The origin of the WGS 84 Cartesian system is the earth's center of mass. The Z-axis is parallel to the direction of the Conventional Terrestrial Pole (CTP) for polar motion, as defined by the Bureau International Heure (BIH), and equal to the rotation axis of the WGS 84 ellipsoid. The X-axis is the intersection of the WGS 84 reference meridian plane and the CTP's equator, the reference meridian being parallel to the zero meridian defined by the BIH and equal to the X-axis of the WGS 84 ellipsoid. The Y-axis completes a right-handed, earth-centered, earth-fixed orthogonal coordinate system, measured in the plane of the CTP equator 90 degrees east of the X-axis and equal to the Y-axis of the WGS 84 ellipsoid. This system is illustrated in Figure 3-1 above. The DoD continuously monitors the origin, scale, and orientation of the WGS 84 reference frame and references satellite orbit coordinates to this frame. Updates are shown as WGS 84 (GXXX), where "XXX" refers to a GPS week number starting on 29 September 1996.

b. Prior to the development of WGS 84, there were several reference ellipsoids and interrelated coordinate systems (datums) that were used by the surveying and mapping community. Table 3-1 lists just a few of these reference systems along with their mathematical defining parameters. Transformation techniques are used to convert between different datums and coordinate systems. Most GPS software has built in transformation algorithms for the more common datums.

Table 3-1. Reference Ellipsoids and Related Coordinate Systems

Reference Ellipsoid	Coordinate System (Datum/Frame)	Semimajor axis (meters)	Shape (1/flattening)
Clarke 1866	NAD 27	6378206.4	1/294.9786982
WGS 72	WGS 72	6378135	1/298.26
GRS 80	NAD 83 (XX)	6378137	1/298.257222101
WGS 84	WGS 84 (GXXX)	6378137	1/298.257223563
ITRS	ITRF (XX)	6378136.49	1/298.25645

3-4. Horizontal Datums and Reference Frames

A major USACE application of differential GPS surveying is densifying military construction and civil works project control. This densification is usually done relative to an existing horizontal datum (NAD 27, NAD 83, or local). Even though GPS measurements are made relative to the WGS 84 ellipsoidal coordinate system, coordinate differences (i.e. baseline vectors) on this system can, for practical engineering purposes, be used directly on any local user datum. Thus, a GPS-coordinated WGS 84 baseline can be directly used on an NAD 27, NAD 83, or even a local project datum. Minor variations between these datums will be minimal when GPS data are adjusted to fit between local datum stations. Such assumptions may not be valid when high-order National Geodetic Reference System (NGRS) network densification work is being performed or where coordinates are developed relative to distant reference stations. The following paragraphs describe some of the reference systems used by the Corps for military construction and civil works projects. Much of it is extracted from *Modern Terrestrial Reference Systems*, (Snay & Soler 1999). Far more detailed descriptions of these reference systems can be found in the referenced publication (*Professional Surveyor Magazine*).

a. *North American Datum of 1927 (NAD 27)*. NAD 27 is a horizontal datum based on a comprehensive adjustment of a national network of traverse and triangulation stations. NAD 27 is a best fit for the continental United States. The fixed datum reference point is located at Meades Ranch, Kansas.

The longitude origin of NAD 27 is the Greenwich Meridian with a south azimuth orientation. The original network adjustment used 25,000 stations. The relative precision between initial point monuments of NAD 27 is by definition 1:100,000, but coordinates on any given monument in the network contain errors of varying degrees. As a result, relative accuracies between points on NAD 27 may be far less than the nominal 1:100,000. The reference units for NAD 27 are US Survey Feet. This datum is no longer supported by NGS, and USACE commands are gradually transforming their project coordinates over to the NAD 83 described below. Approximate conversions of points on NAD 27 to NAD 83 may be performed using CORPSCON, a transformation program developed by ERDC/TEC--see EM 1110-1-1004. Since NAD 27 contains errors approaching 10 m, transforming highly accurate GPS observations to this antiquated reference system is not the best approach.

b. North American Datum of 1983 (NAD 83). The nationwide horizontal reference network was redefined in 1983 and readjusted in 1986 by the National Geodetic Survey. It is known as the North American Datum of 1983, adjustment of 1986, and is referred to as NAD 83 (1986). NAD 83 used far more stations (250,000) and observations than NAD 27, including a few satellite-derived coordinates, to readjust the national network. The longitude origin of NAD 83 is the Greenwich Meridian with a north azimuth orientation. The fixed adjustment of NAD 83 (1986) has an average precision of 1:300,000. NAD 83 is based upon the Geodetic Reference System of 1980 (GRS 80), an earth-centered reference ellipsoid which for most (but not all) practical purposes is equivalent to WGS 84. With increasingly more accurate uses of GPS, the errors and misalignments in NAD 83 (1986) became more obvious (they approached 1 meter), and subsequent refinements outlined below have been made to correct these inconsistencies.

c. High Accuracy Reference Networks (HARN). Within a few years after 1986, more refined GPS measurements had allowed geodesists to locate the earth's center of mass with a precision of a few centimeters. In doing so, these technologies revealed that the center of mass that was adopted for NAD 83 (1986) is displaced by about 2 m from the true geocenter. Similarly, it was found that the orientation of the NAD 83 (1986) Cartesian axes is misaligned by over 0.03 arc seconds relative to their true orientation, and that the NAD 83 (1986) scale differs by about 0.0871 ppm from the true definition of a meter. These discrepancies caused significant concern as the use of highly accurate GPS measurements proliferated. Starting with Tennessee in 1989, each state--in collaboration with NGS and various other institutions--used GPS technology to establish regional reference frames that were to be consistent with NAD 83. The corresponding networks of GPS control points were originally called High Precision Geodetic Networks (HPGN). Currently, they are referred to as High Accuracy Reference Networks (HARN). This latter name reflects the fact that relative accuracies among HARN control points are better than 1 ppm, whereas relative accuracies among pre-existing control points were nominally only 10 ppm. The NGS opted to introduce a new scale that would be consistent with the scale of the then current global reference system known as the International Terrestrial Reference Frame of 1989 (ITRF 89). The ITRF 89 scale was based on a combination of GPS, Very Long Baseline Interferometry (VLBI), and Lunar-Laser-Ranging (LLR) measurements. The resulting scale change, equal to -0.0871 ppm, altered existing NAD 83 latitudes and longitudes insignificantly, but it systematically decreased all ellipsoidal heights by about 0.6 m. Nevertheless, this change to a more accurate scale facilitated the migration toward using GPS technology for deriving accurate orthometric heights. Positional differences between NAD 83 (1986) and NAD 83 (HARN) can approach 1 meter.

d. Continuously Operating Reference Stations (CORS). The regional HARNs were subsequently further refined (or "realized") by NGS into a network of Continuously Operating Reference Stations, or CORS. This CORS network was additionally incorporated with the International Terrestrial Reference System (ITRS), i.e. the ITRF. CORS are located at fixed points throughout CONUS and at some OCONUS points--see Figure 3-2. This network of high-accuracy points can provide GPS users with centimeter level accuracy where adequate CORS coverage exists. Coordinates of CORS stations are

designated by the year of the reference frame, e.g., NAD 83 (CORS 96). Positional differences between NAD 83 (HARN) and NAD 83 (CORS) are less than 10 cm. More importantly, relative positional differences between two NAD 83 (CORSxx) points is typically less than 2 cm. Thus, GPS connections to CORS stations will be of the highest order of accuracy. USACE commands can easily connect and adjust GPS-observed points directly with CORS stations using a number of methods, including the NGS on-line program OPUS (On-Line Positioning User Service), which is described more completely in Chapter 10. OPUS provides centimeter-level adjustment connections with three nearby CORS stations, and outputs adjusted coordinates in the latest epochs of NAD 83 and ITRF systems.

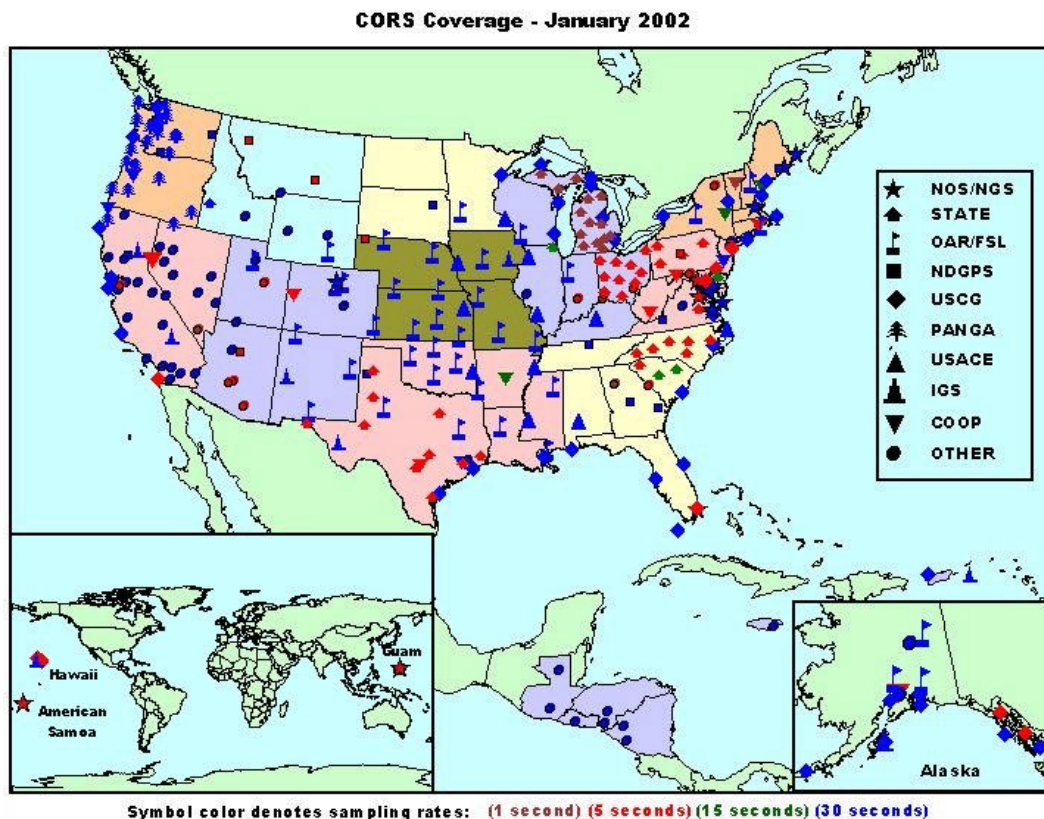

Figure 3-2. Continuously Operating Reference Stations (NGS)

e. International Terrestrial Reference Frame (ITRF). The ITRF is a highly accurate geocentric reference frame with an origin at the center of the earth's mass. The ITRF is continuously monitored and updated by the International Earth Rotation Service (IERS) using very-long-baseline-interferometry (VLBI) and other techniques. These observations allow for the determination of small movements of fixed points on the earth's surface due to crustal motion, rotational variances, tectonic plate movement, etc. These movements can average 10 to 20 mm/year in CONUS (see Figure 3-3 below), and may become significant when geodetic control is established from remote reference stations. These refinements can be used to more accurately determine GPS positions observed on the basic WGS 84 reference frame. NAD 83 coordinates are defined based on the ITRF year/epoch in which it is defined, e.g., ITRF 89, ITRF 96, ITRF 2000. For highly accurate positioning where plate velocities may be significant, users should use the same coordinate reference frame and epoch for both the satellite orbits and the terrestrial reference frame. USACE requirements for these precisions would be rare.

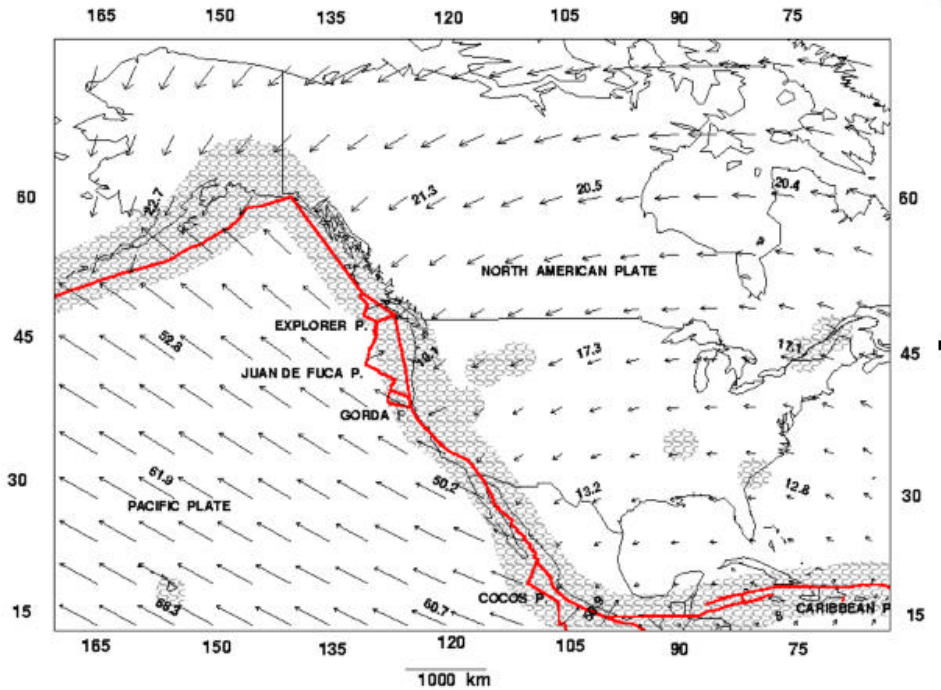

Figure 3-3. ITRF horizontal velocities in mm/year (NGS)

3-5. Transforming between Horizontal Survey Datums

Differential GPS observations routinely provide horizontal baseline accuracies on the order of 1 ppm. This far exceeds the stated 1:300,000 accuracy for NAD 83 and (approximately) 1:100,000 for NAD 27. Distortions in NAD 27 can be as much as 10 m, up to 1 m in NAD 83 (1986), and a few centimeters in NAD 83 (HARN) points. Thus, approximate transformations (e.g., CORPSCON) will retain the original distortions in the networks. Even though GPS has such a high degree of precision, it provides only coordinate differences; therefore, ties to the national network to obtain coordinates of all GPS stations must be done without distorting the established project control network (i.e. the GPS-derived vectors are "degraded" during the adjustment to "fit" the local network). Generally, on mid-size survey projects, three or more horizontal control stations from the national network can be used during the GPS observation scheme. Direct connections to CORS stations can also be made in order to update a project's control scheme to the National network. These highly accurate CORS connections will often be more accurate than the original project control scheme, and can be referenced to the latest NGS NAD/ITRF time-dependent reference frame if needed. NGS has developed a software package that provides time-related transformations between the varied NAD 83 and ITRF reference frames--"Horizontal Time-Dependent Positioning" or HTDP. This software transforms positions and velocities between ITRF xx, WGS 84 (Gxxx), and NAD 83. It updates and predicts displacements between dates (epochs) due to crustal motion. In order to facilitate a tie between GPS and existing networks for horizontal control, a re-adjustment of the whole local project network scheme (all control and GPS-derived points) should be performed. There are many commercial software packages that can be used to perform this adjustment.

Once a network adjustment meets the accuracy requirement, those values should not be readjusted with additional points or observations unless a complete readjustment is performed.

a. Transforming to local project datums. Corps construction and navigation projects are often based on local project datums. Usually, but not always, these local station-offset datums are referenced to the NGRS. They may also have SPCS coordinates of uncertain origin. These local datums might be accurate within a small area, but can become distorted over larger areas. When local project datums are not connected to any regional datum, GPS ties can be observed to outside control in order to transform the local datum to an established reference datum. GPS receiver vendors usually provide software transformation options for converting WGS 84 coordinates to local datums. For small survey areas, a Three-Parameter Transformation is adequate. For larger areas, a Seven-Parameter Transformation should be performed. In addition, local horizontal control coordinates must be "calibrated" to the WGS 84 scheme used by GPS. This is termed "site calibration" in Trimble software. Although only two points are required, at least three established control points should be occupied (and connecting baselines observed) to perform a datum transformation. These observations provide horizontal translation, rotation, and scale parameters between the two grids. Thus, with these datum translations and calibrations, observed GPS data is "best-fit" onto the local grid system. Many least squares adjustment packages also contain datum transformation routines that can be used to convert local datums to regional networks.

b. State Plane Coordinate System (SPCS). The State Plane Coordinate System (SPCS) was developed by the NGS to provide a planar representation of the earth's surface. Most USACE civil and military projects require project coordinates in a SPCS format, or occasionally in the military Universal Transverse Mercator (UTM) plane coordinate system. To properly relate spherical coordinates (f, l) to a planar system (Northings and Eastings), a developable surface must be constructed. A developable surface is defined as a surface that can be expanded without stretching or tearing. The two most common developable surfaces or map projections used in surveying and mapping are the cone and cylinder. The projection of choice is dependent on the north-south or east-west extent of the region. Areas with limited east-west dimensions and elongated north-south extent utilize the cylindrical Transverse Mercator projection. Areas with limited north-south dimensions and elongated east-west extent utilize the conical Lambert projection. SPCS are different for the NAD 27 and NAD 83 reference systems. Figure 3-4 below shows the layout for the various SPCS (NAD 83) zones. For further information on the State Plane Coordinate System see EM 1110-1-1004.



Figure 3-4. State plane coordinate zones (NAD 83)

c. Practical considerations in USACE. Few, if any, USACE civil works and military construction projects require high-precision geodetic control referenced to the latest ITRF time epoch to account for polar motion, tectonic plate movement, etc. These refinements require additional observation and office adjustment and analysis time, and can significantly increase project costs. Requirements for high precision geodetic control are a function of project function and size. For example, a major watershed with significant hydraulic complications may require high-accuracy CORS connections for vertical control purposes. However, a small, shallow-draft navigation project that is dredged once every 3 years would not need these high-order framework references. In addition, repeated transforms and readjustments of project control can result in mixed reference schemes, and can cause construction claims. This may occur if subsequent users performing topographic or GIS mapping use superseded coordinate systems. Thus, project managers and surveyors need to consider the project function and future developments in determining the framework accuracy.

3-6. Orthometric Elevations

Orthometric elevations are those corresponding to the earth's irregular geoidal surface, as illustrated in Figure 3-5 below. Measured differences in elevation from spirit leveling are generally relative to the local geoidal surface--a spirit level bubble (or pendulum) positions the instrument normal to the direction

of gravity, and thus parallel with the local slope of the geoid. The orthometric height of a point is the distance from the geoid (or a related reference surface) to the point on the earth's surface, measured along the line perpendicular to every equipotential surface in between. A series of equipotential surfaces can be used to represent the gravity field. One of these surfaces, the geoid, is specified as the reference system from which orthometric heights are measured. The geoid itself is defined as an equipotential surface. Natural variations in gravity induce a smooth, continuous, curvature to the plumb line, and therefore physical equipotential surfaces which are normal to gravity do not remain geometrically parallel over a given vertical distance (i.e. the plumb line is not quite parallel to the ellipsoidal normal). Elevation differences between two points are orthometric differences, a distinction particularly important in river/channel hydraulics. Orthometric heights for the continental United States (CONUS) are generally referenced to the National Geodetic Vertical Datum of 1929 (NGVD 29) or the updated North American Vertical Datum of 1988 (NAVD 88); however, other vertical datums may be used in some projects (e.g., the International Great Lakes Datum of 1955 (IGLD 55) and the revised International Great Lakes Datum of 1985 (IGLD 85). Hydraulic-based "dynamic" elevation datums, such as IGLD, differ from orthometric elevations in that elevation differences are based on hydraulic head (i.e. work) differences. The NGVD 29 reference datum approximates mean sea level--the NAVD 88 does not. Tidal reference datums (e.g., MLLW) vary geographically over short distances and must be accurately related to NAVD 88 and/or NGVD 29 orthometric heights. River systems may have local flow/discharge referenced datums--see EM 1110-2-1003. GPS derived ellipsoidal heights shown in Figure 3-5 below must be converted to local orthometric elevations in order to have useful engineering and construction value. This transformation is usually done by a form of "site calibration" using known orthometric elevations of fixed benchmarks and/or geoid undulation models for the project area. These transforms are further explained below.

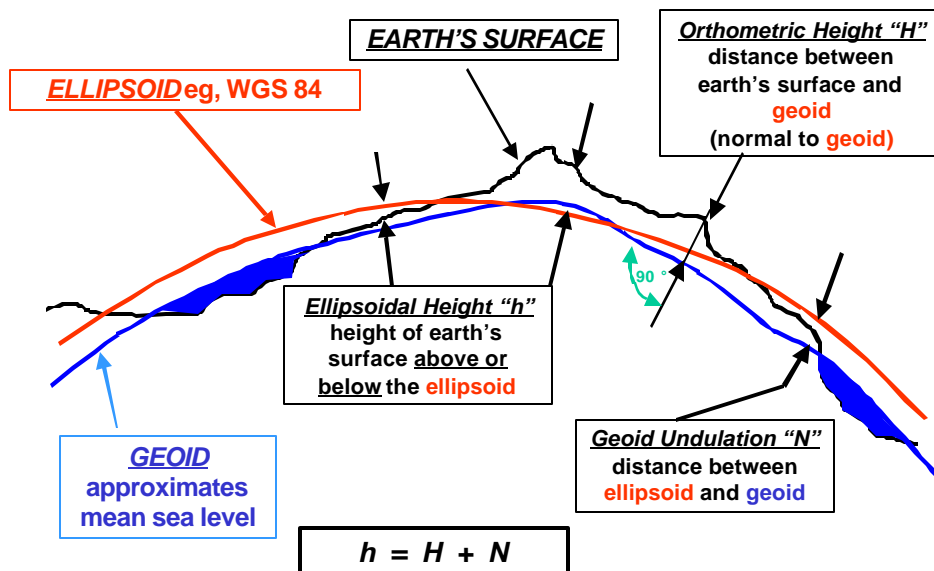

Figure 3-5. Ellipsoid, geoid, and earth's surface definitions and relationships

3-7. WGS 84 Ellipsoidal Heights

In the US, final positions from DGPS are established with respect to NAD 83. Since NAD 83 is based on the GRS 80 ellipsoid, ellipsoid heights obtained from GPS surveying using NAD 83 control are based on the GRS 80 ellipsoid. These heights are referred to as NAD 83 GPS ellipsoidal heights. Unlike the WGS 84 ellipsoid, the GRS 80 ellipsoid is not exactly geocentric, which can create problems (i.e. large errors) when converting NAD 83 GPS ellipsoid heights to orthometric heights using some geoid models. GPS-determined heights (or height differences) are referenced to an idealized mathematical ellipsoid that differs significantly from the geoid; thus, GPS heights are not the same as the orthometric heights needed for standard USACE projects (i.e. local engineering, construction, and hydraulic measurement functions). Accordingly, any WGS 84 referenced ellipsoidal height obtained using GPS must be transformed or calibrated to the local orthometric vertical datum. This requires adjusting and interpolating GPS-derived heights relative to fixed orthometric elevations. Over short distances--less than 1 km--elevation differences determined by GPS can usually be assumed to be orthometric differences. These elevation differences would then be of sufficient accuracy for topographic site plan mapping, such as those acquired using RTK total station methods. However, when GPS is used to establish primary vertical control benchmarks for a project, special procedures and cautions must be observed, e.g., measurements should be made relative to higher-order NGRS benchmarks in order to develop the best model for a project. Such a process may or may not be of suitable accuracy (i.e. reliability) for establishing primary control on some engineering and construction work--see Chapter 8.

3-8. Orthometric Height and WGS 84 Ellipsoidal Elevation Relationship

Geoidal heights represent the geoid-ellipsoid separation distance measured along the ellipsoid normal and are obtained by taking the difference between ellipsoidal and orthometric height values. Knowledge of the geoid height enables the evaluation of vertical positions in either the geodetic (ellipsoid based) or the orthometric height system. The relationship between a WGS 84 ellipsoidal height and an orthometric height relative to the geoid can be obtained from the following equation, as depicted graphically in Figure 3-5 above.

$$h = H + N \quad \text{(Eq 3-1)}$$

where

- h = ellipsoidal height (WGS 84)
- H = elevation (orthometric--normal to geoid)
- N = geoidal undulation above or below the WGS 84 ellipsoid

and by convention the geoid undulation " N " being a positive height when above the ellipsoid.

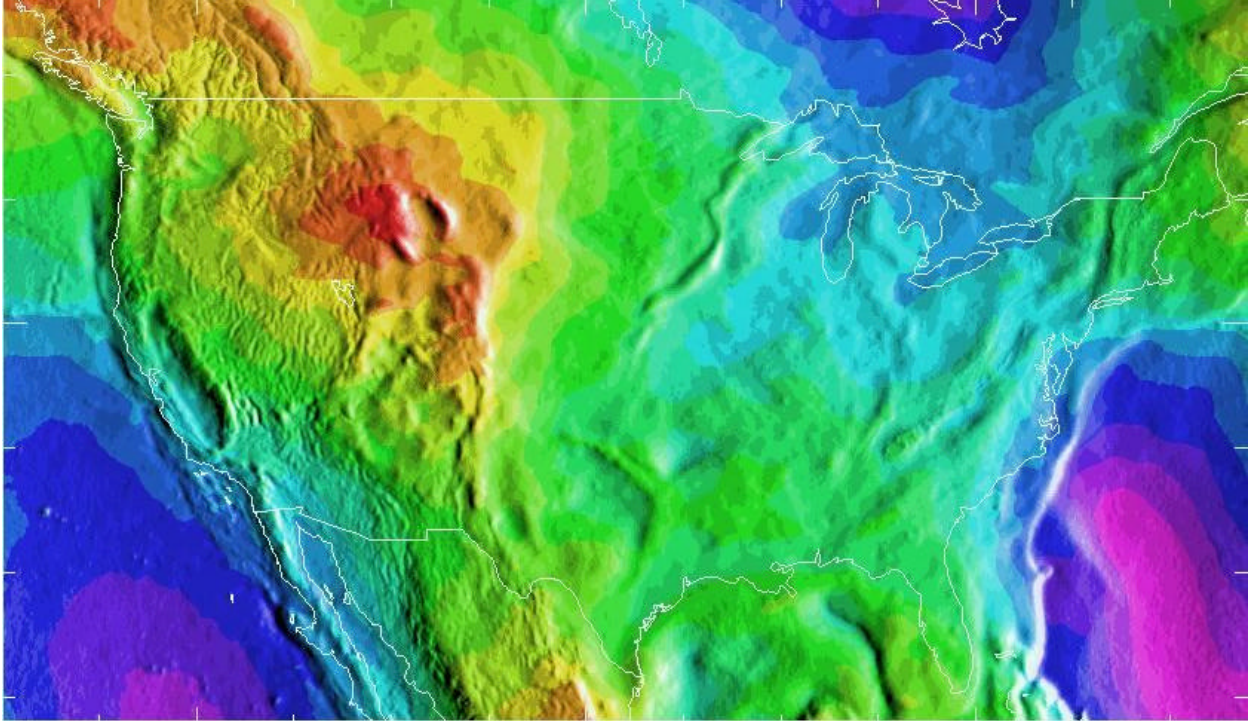

Figure 3-6. Geoid undulation model of North America--depicts geoid undulation " N " relative to the WGS 84 ellipsoid

3-9. Geoid Undulations and Geoid Models

Due to significant variations in the geoid, sometimes even over small distances, elevation differences obtained by GPS cannot be directly equated to orthometric (or spirit level) differences. This geoid variation is depicted as a surface model in Figure 3-6 above. Geoid modeling techniques are used to obtain the parameter " N " in Equation 3-1, from which ellipsoidal heights can be converted to orthometric elevations. These geoid models (e.g., Geoid 90, Geoid 93, Geoid 96, Geoid 99, etc.) are approximations based on observations by the NGS. Each successive geoid model is more accurate. In time, these models may improve to centimeter-level accuracy. On some small project areas where the geoid stays fairly constant, elevation differences obtained by GPS can be directly used without geoid correction. Geoid models are not compatible with the superseded NGVD 29.

a. Geoid height values at stations where either only " h " or " H " is known can be obtained from geoid models that are mathematical surfaces representing the shape of the earth's gravity field. The geoid model is constructed from a truncated functional series approximation using a spherical harmonics expansion and an extensive set of globally available gravity data. The model is determined from the unique coefficients of the finite series representing the geoid surface. Its accuracy depends on the coverage and accuracy of the gravity measurements used as boundary conditions. Former geoid models produced for general use limit absolute accuracies for geoid heights to no less than 1 meter. More recent geoid models have shown a significant increase in geoid height absolute accuracy--down to the centimeter level.

b. In practice, the shape of the geoid surface is estimated globally as a function of horizontal coordinates referenced to a common geocentric position. Specific geoid height values are extracted from the model surface at the node points of a regular grid (i.e. a 2-minute x 2-minute grid spacing). Biquadratic interpolation procedures can be used within a grid cell boundary to approximate the geoid

height at a given geodetic latitude and longitude. For example, the NGS GEOID 96 model for the United States indicates geoid heights (N) range from a low of (-) 51.6 meters in the Atlantic to a high of (-) 7.2 meters in the Rocky Mountains. For more information on geoid modeling, see the references listed in Appendix A.

c. GPS surveys can be designed to provide elevations of points on any local vertical datum. This requires connecting to a sufficient number of existing orthometric benchmarks from which the elevations of unknown points can be "best-fit" or "site calibrated" by some adjustment method--usually a least-squares minimization. This is essentially an interpolation process and assumes linearity in the geoid slope between two established benchmarks. If the geoid variation is not linear--as is typically the case--then the adjusted (interpolated) elevation of an intermediate point will be in error. Depending on the station spacing, location, local geoid undulations, and numerous other factors, the resultant interpolated/adjusted elevation accuracy is usually not suitable for construction surveying purposes; however, GPS-derived elevations may be adequate for small-scale topographic mapping control.

3-10. North American Vertical Datum of 1988 (NAVD 88)

The NAVD 88 datum is the product of a vertical adjustment of leveled height difference measurements made across North America. This reference system supersedes the NGVD 29 vertical reference framework. NAVD 88 was constrained by holding fixed the orthometric height of a single primary tidal benchmark at Father's Point / Rimouski, Quebec, Canada and performing a minimally constrained general adjustment of US-Canadian-Mexican leveling observations. The vertical reference surface is therefore defined by the surface on which the gravity values are equal to the control point value. NAVD 88 elevations are published orthometric heights that represent the geometric distance from the geoid to the terrain measured along the plumb line. Orthometric height corrections were used to enforce consistency between geopotential based vertical coordinates and measured leveled differences. NAVD 88 is the most compatible vertical reference frame available to relate GPS ellipsoidal heights to orthometric heights. Note also that NGVD 29 is no longer supported by NGS; thus, USACE commands should be transitioning all older project vertical control to NAVD 88. The differences in orthometric elevations between the superseded NGVD 29 and NAVD 88 references are significant--upwards of 1.5 meters in places, as depicted in Figure 3-7 below. Therefore, it is important that these two reference systems not be confused. Given the local variations shown in Figure 3-7, there is no direct transformation between the two systems, and a site calibration/transformation must be performed as explained in subsequent sections.

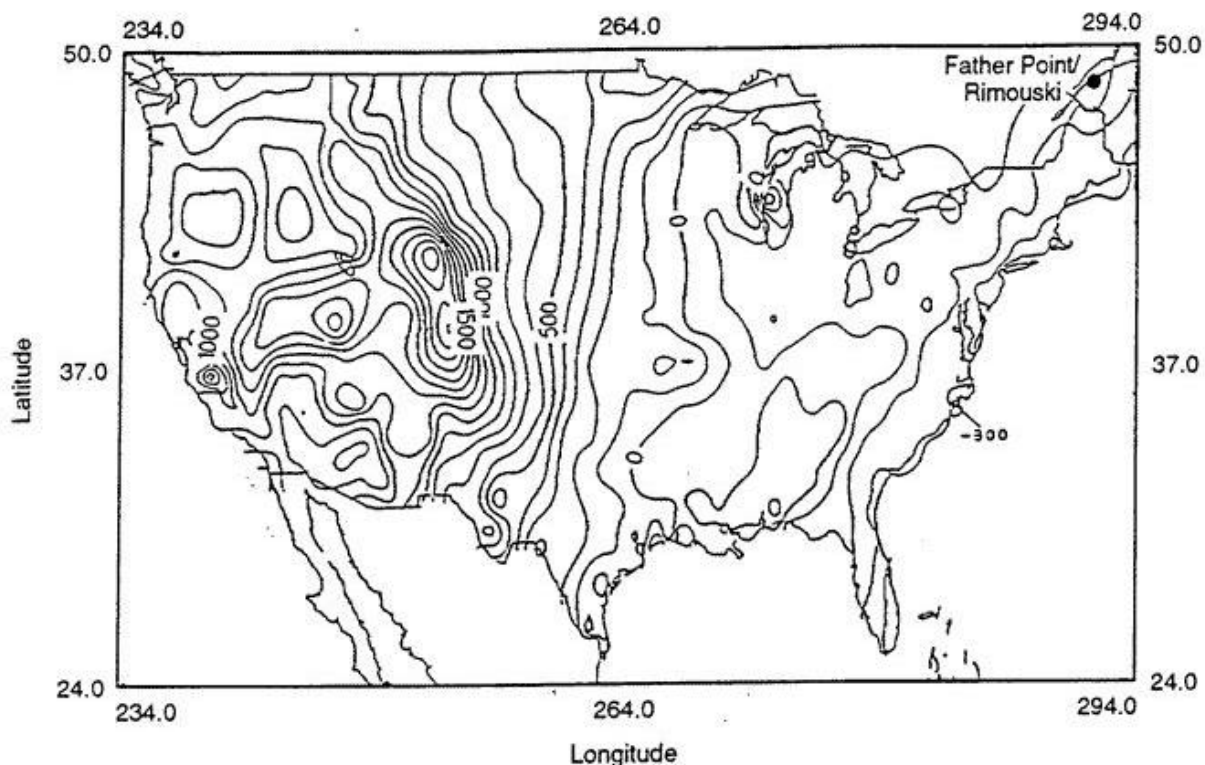

Figure 3-7. NGVD 29-NAVD 88 elevation differences in mm

3-11. Using GPS to Densify Orthometric Elevations

DGPS observation sessions produce 3-D geodetic coordinate differences that establish the baseline between two given stations. The expected accuracy of ellipsoidal height difference measurements is based on several factors, such as GPS receiver manufacture type, observation session duration, and the measured baseline distance, but it does not depend greatly on prior knowledge of the absolute vertical position of either occupied station. Dual-frequency, carrier phase measurement based GPS surveys are usually able to produce 3-D relative positioning accuracies under 30 mm at the 95% confidence level over baseline distances less than 20 km, depending on the type of GPS surveying method used. This situation exists mainly because GPS range biases are physically well correlated over relatively short distances and tend to cancel out as a result of forming double differences for carrier phase data processing. In contrast, GPS absolute code positioning accuracy will contain the full effects of any GPS range measurement errors. Geoidal height differences describe the change in vertical position of the geoid with respect to the ellipsoid between two stations. These relative geoidal heights can be more accurate than the modeled absolute separation values within extended areas because the relative geoidal height accuracy is based on the continuous surface characteristics of the geoid model, where only small deviations between closely spaced points would be expected. The regional trend or slope of the geoid at a given point will not be highly sensitive to local gravity anomalies especially in non-mountainous areas. Differential GPS can fairly accurately measure ellipsoidal height differences from GPS satellites. GPS surveys output vertical positions in geodetic coordinates defined with respect to the WGS 84 reference ellipsoid. The ellipsoidal height value at a given point is based on the distance measured along the normal vector from the surface of the reference ellipsoid to the point. The practical accuracy of WGS 84 as a vertical reference frame for

collecting elevation data depends on the actual ellipsoidal height values assigned to benchmarks or other physically defined control points.

3-12. GPS Vertical Site Calibration

A calibration is needed in real-time surveying in order to relate GPS positions that are measured in terms of WGS-84 to local grid coordinate projections, such as SPCS, UTM, or a local station-offset-elevation system. In addition, a vertical calibration is needed to adjust the observed GPS ellipsoid elevations to a local vertical datum, and account for undulations in the local geoid over the project area. A calibration should be used on a project whenever new points are to be established. A calibration is based on a set of points that have 3-D coordinates in both WGS-84 and the local grid coordinate projection system. The quality of the calibration will be affected by the accuracy and consistency of the GPS coordinates of the points. Points tied to the NGRS are recommended as the basis of a calibration. The number of points that can be used in a calibration is manufacturer and software dependent. Smaller sized projects may be calibrated with one 3-D point. However, for larger sized projects, three or four 3-D points are recommended. Calibration points should be well distributed around the project exterior. Projects may be calibrated by two methods: (1) in the field in the survey data collector or (2) in the network adjustment. The latter procedure is recommended for large projects. The calibration computation summary should be examined for reasonable results in the horizontal scale, maximum vertical adjustment inclination, and the maximum horizontal and vertical residuals.

a. Figure 3-8 below illustrates the varied requirements for vertical site calibrations. This figure depicts a typical contour plot of a geoid model--height differences between the geoid relative to the WGS 84 ellipsoid. In the large (8 km x 8 km) Area A, the geoid undulation varies from 0.80 to 1.27 m--nearly a 50 cm variation. In order to determine accurate orthometric elevations from GPS ellipsoid elevation observations, this variation in the geoid must be accurately accounted for. In addition, the published orthometric elevations at each of the 7 established control benchmarks may not fit exactly with the geoid model--the geoid model may have been approximated from other NGRS points. Therefore, GPS observations over the 7 established control network points must be adjusted to further refine the geoid model so that subsequent GPS observations to any point in the project area can be "best-fitted" to the local vertical datum. Solely relying on a published geoid model is not recommended--connections with existing control should always be observed to refine the model. GPS adjustment software must be able to compensate for both the variations in the geoid model and variations in the established control benchmarks. In order to accomplish this, GPS observations need to be connected between the fixed control benchmarks, as shown in Area A.

b. The small (1 km x 1 km) Area B in Figure 3-8 is more typical of local RTK topographic survey projects. The geoid model shows a minimal undulation over this area--from 0.72 m to 0.75 m. This 3 cm variation may or may not be significant, depending on the required elevation accuracy of the survey. If this 3 cm geoid variation is not considered significant, then the geoid undulation at the selected reference station could be used over the entire area, and no geoid model correction used. Alternatively, the 2 control benchmarks could be calibrated and the geoid model included in the adjustment. When 2 control benchmarks are available, as shown around Area B, then a GPS check between the benchmarks is recommended. If the geoid model is not used, the geoid correction could be interpolated from the check baseline observation results, holding the 2 control points fixed.

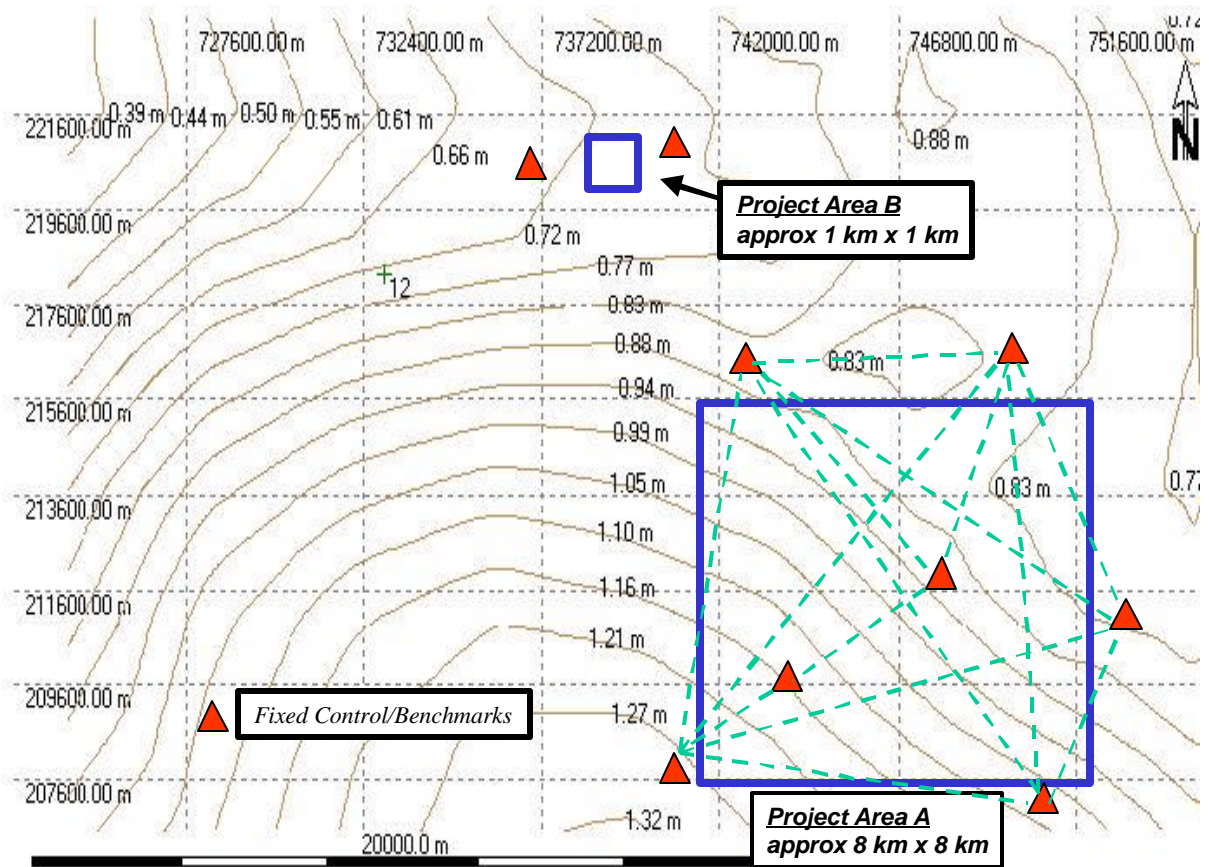

Figure 3-8. Plot of geoid undulation contours over a local survey area (Leica)

c. Figure 3-9 below illustrates vertical calibrations over small local survey areas, which is typical of Corps topographic survey applications. This area contains two fixed benchmarks with local datum elevations. A GPS reference receiver is set up over one benchmark and baseline hubs are staked out relative to this point, using kinematic techniques. The second fixed benchmark is used as a check point. A local geoid model shows estimated geoid heights varying between -11.23 and -11.25 m. Orthometric elevations on the individual baseline hubs are computed by correcting the observed ellipsoidal elevation differences with the local geoid undulation differences. This local geoid elevation difference (- 2 cm) could have been ignored if this error is acceptable to project accuracy requirements. This would, in effect, assume observed ellipsoidal elevation differences are equal to orthometric elevation differences and no geoid model corrections are applied to the observations.

d. In Figure 3-9, a check point GPS elevation difference of +12.40 m is observed. The published orthometric elevation difference between these points is +12.42 m. This confirms the geoid model is accurate over this area since the computed geoid undulation difference (ΔN) is - 0.02 m (+12.40-12.42). Had a large misclosure existed at the check point, then either the published elevations are inaccurate or the geoid model is inaccurate, or both. A GPS baseline check to a third benchmark would be required, or conventional levels could be run between the two fixed points to resolve the problem.

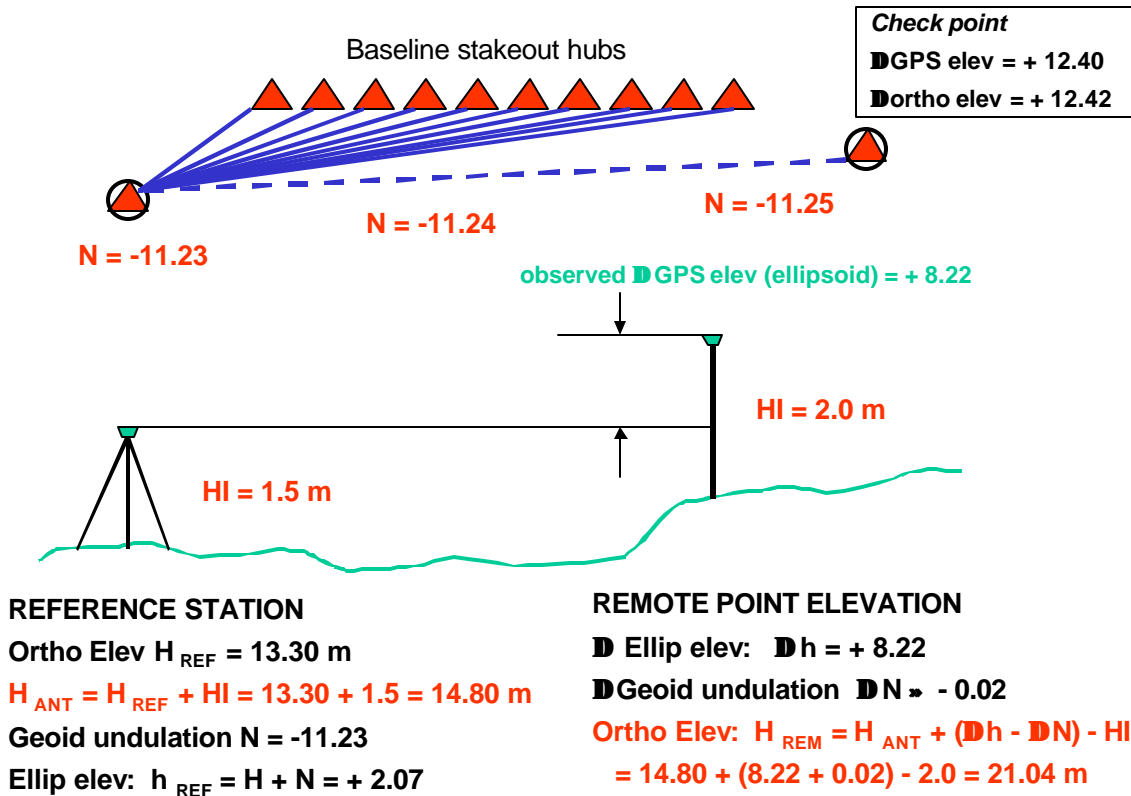

Figure 3-9. Geoid elevation corrections for localized surveys

e. For further references on GPS site calibrations, refer to Trimble's *Real-Time Surveying Workbook* (Trimble 2000b).

3-13. GPS Time References

Time used for most purposes is based on an astronomic (solar) time measure, or "universal time"--UT. UT is based on the earth's rotation. Other time references include UT 0 (which is based on astronomical observations), UT 1 (UT 0 corrected for polar motion and equals Greenwich Mean Time--GMT), and Atomic Time (AT). GPS satellites have atomic clocks which output a time base that is not related to astronomic time measures. However, these different time scales can be coordinated. GPS time is accurately maintained and monitored by the DoD. GPS time is usually maintained within 30 nanoseconds of Universal Coordinated Time (US Naval Observatory), or UTC (USNO). GPS time is based on a reference "GPS epoch" of 000 hours (UTC) 6 January 1980. From DoD (1996), the relationship between GPS time and UTC is:

$$\text{GPS time} = \text{UTC} + \text{number of leap seconds} + [\text{GPS-to-UTC bias}]$$

EM 1110-1-1003
1 Jul 03

GPS receivers obtain time corrections from the broadcast data messages and can thus output UTC (USNO) time increments. UTC is the time used for many USACE surveying applications where time is transferred from a GPS receiver in order to coordinate data streams from some peripheral sensing device-- e.g., inertial measurement units (IMU), cameras, acoustic depth recorders, etc. It is especially critical to determine any latencies between the GPS satellite acquisition and the time tag of the subsequent position computation, and to correlate this time tag latency with other peripheral sensors.

Chapter 4 GPS Absolute Point Positioning Determination Concepts, Errors, and Accuracies

4-1. General

As outlined in Chapter 2, the NAVSTAR GPS was originally conceived and designed to provide point positioning and velocity of a user with a single, usually low-cost, hand-held GPS receiver. This is termed "absolute" point positioning, as distinguished from "relative" positioning when a second receiver is employed. GPS absolute positioning is the most widely used military and commercial GPS positioning method for real-time navigation and location. It is usually not sufficiently accurate for precise surveying, mapping, or hydrographic positioning uses--horizontal accuracies are typically only in the 10 to 30 m range. However, there are numerous other Corps applications where absolute point positioning is sufficiently accurate: vessel/vehicle/personnel navigation, emergency operations, reconnaissance mapping, dredge disposal monitoring, etc. This chapter discusses the general concepts of performing absolute point positioning, and some of the basic errors inherent in the process.

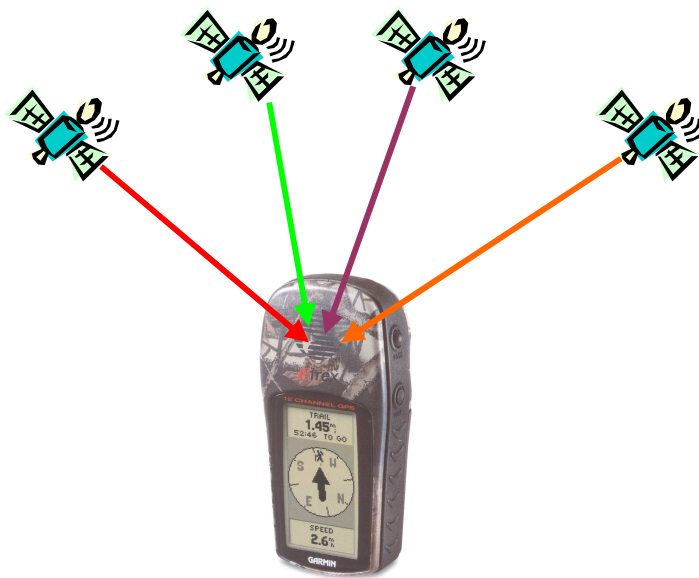

Figure 4-1. Point positioning range measurements from a passive hand-held GPS receiver

4-2. Absolute Point Positioning

Absolute positioning involves the use of only a single passive receiver at the user's location to collect data from multiple satellites in order to determine the user's georeferenced position--see Figure 4-1. GPS determination of a point position on the earth actually uses a technique common to terrestrial surveying called trilateration--i.e. electronic distance measurement resection. The user's GPS receiver simply measures the distance (i.e. ranges) between the earth and the NAVSTAR GPS satellites. The user's

position is determined by the resected intersection of the observed ranges to the satellites. At least 3 satellite ranges are required to compute a 3-D position. In actual practice, at least 4 satellite observations are required in order to resolve timing variations. Adding more satellite ranges will provide redundancy (and more accuracy) in the position solution. The resultant 3-D coordinate value is relative to the geocentric reference system. The GPS receiver may be operated in a static or dynamic mode. The accuracies obtained by GPS absolute positioning are dependent on the user's GPS receiver quality, location, and length of observation time, DOP, and many other factors. Accuracies to less than a meter can be obtained from static, long-term absolute GPS measurements when special equipment and post-processing techniques are employed. Future GPS satellite modernization upgrades, enhanced code and carrier processing techniques, and other refinements are expected to significantly improve the accuracy of absolute positioning such that meter-level navigation accuracies may be available in real-time.

4-3. GPS Absolute Position Solution Process--Pseudoranging

When a GPS user performs a navigation solution, only an approximate range, or "pseudorange," to selected satellites is measured. In order for the GPS user to determine his precise location, the known range to the satellite and the position of those satellites must be known. By pseudoranging, the GPS user measures an approximate distance between the GPS antenna and the satellite by correlation of a satellite-transmitted code and a reference code created by the receiver. This measurement does not contain corrections for synchronization errors between the clock of the satellite transmitter and that of the GPS receiver. The distance the signal has traveled is equal to the velocity of the transmission multiplied by the elapsed time of transmission. The signal velocity is affected by tropospheric and ionospheric conditions in the atmosphere. Figure 4-2 illustrates this pseudoranging concept.

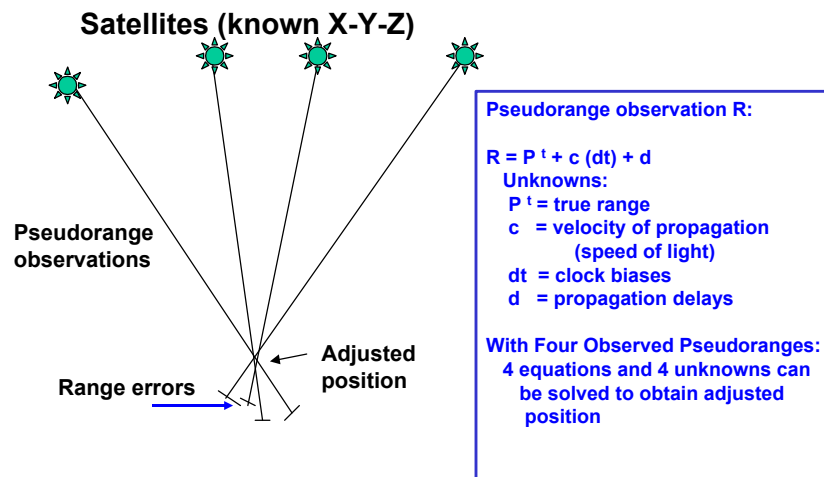

Figure 4-2. Pseudoranging technique

a. The accuracy of the positioned point is a function of the range measurement accuracy and the geometry of the satellites, as reduced to spherical intersections with the earth's surface. A description of the geometrical magnification of uncertainty in a GPS determined point position is termed "Dilution of

Precision" (DOP), which is discussed in a later section. Repeated and redundant range observations will generally improve range accuracy. However, the dilution of precision remains the same. In a static mode (meaning the GPS receiver antenna stays stationary), range measurements to each satellite may be continuously remeasured over varying orbital locations of the satellites. The varying satellite orbits cause varying positional intersection geometry. In addition, simultaneous range observations to numerous satellites can be adjusted using weighting techniques based on the elevation and pseudorange measurement reliability.

b. Four pseudorange observations are needed to resolve a GPS 3-D position. (Only three pseudorange observations are needed for a 2-D location.) In practice there are often more than four satellites within view. A minimum of four satellite ranges are needed to resolve the clock biases contained in both the satellite and the ground-based receiver. Thus, in solving for the X-Y-Z coordinates of a point, a fourth unknown (i.e. clock bias-- Δt) must also be included in the solution. The solution of the 3-D position of a point is simply the solution of four pseudorange observation equations containing four unknowns, i.e. X, Y, Z, and Δt .

c. A pseudorange observation is equal to the true range from the satellite to the user plus delays due to satellite/receiver clock biases and other effects.

$$R = p^t + c(\Delta t) + d \quad (\text{Eq 4-1})$$

where

- R = observed pseudorange
- p^t = true range to satellite (unknown)
- c = velocity of propagation
- Δt = clock biases (receiver and satellite)
- d = propagation delays due to atmospheric conditions

Propagation delays (d) are usually estimated from atmospheric models.

The true range " p^t " is equal to the 3-D coordinate difference between the satellite and user.

$$p^t = [(X^s - X^u)^2 + (Y^s - Y^u)^2 + (Z^s - Z^u)^2]^{1/2} \quad (\text{Eq 4-2})$$

where

X^s, Y^s, Z^s = known satellite geocentric coordinates from ephemeris data

X^u, Y^u, Z^u = unknown geocentric coordinates of the user which are to be determined.

When four pseudoranges are observed, four equations are formed from Equations 4-1 and 4-2.

$$(R_1 - c \Delta t - d_1)^2 = (X_1^s - X^u)^2 + (Y_1^s - Y^u)^2 + (Z_1^s - Z^u)^2 \quad (\text{Eq 4-3})$$

$$(R_2 - c \Delta t - d_2)^2 = (X_2^s - X^u)^2 + (Y_2^s - Y^u)^2 + (Z_2^s - Z^u)^2 \quad (\text{Eq 4-4})$$

$$(R_3 - c \Delta t - d_3)^2 = (X_3^s - X^u)^2 + (Y_3^s - Y^u)^2 + (Z_3^s - Z^u)^2 \quad (\text{Eq 4-5})$$

$$(R_4 - c \Delta t - d_4)^2 = (X_4^s - X^u)^2 + (Y_4^s - Y^u)^2 + (Z_4^s - Z^u)^2 \quad (\text{Eq 4-6})$$

In these equations, the only unknowns are X^u, Y^u, Z^u , and Δt . Solving these four equations for the four unknowns at each GPS update yields the user's 3-D position coordinates-- X^u, Y^u, Z^u . These geocentric coordinates can then be transformed to any user reference datum. Adding more pseudorange observations

provides redundancy to the solution. For instance, if seven satellites are simultaneously observed, seven equations are derived and still only four unknowns result.

d. This solution quality is highly dependent on the accuracy of the known coordinates of each satellite (i.e. X^s , Y^s , and Z^s), the accuracy with which the atmospheric delays "d" can be estimated through modeling, and the accuracy of the resolution of the actual time measurement process performed in a GPS receiver (clock synchronization, signal processing, signal noise, etc.). As with any measurement process, repeated and long-term observations from a single point will enhance the overall positional reliability.

4-4. GPS Point Positioning Accuracies

Determining the accuracy of a point position derived from GPS observations is a complex and highly variable process. Any specified accuracy (or claimed accuracy) is subject to many qualifications and interpretations--see *Global Positioning System Standard Positioning Service Performance Standard* (DoD 2001). This is due to the numerous components that make up the "error budget" of a GPS observation. Thus, resultant horizontal positional accuracies for absolute point positioning typically range between 10 m and 30 m, and much larger for elevation measurements. Some of the more significant components of the error budget include:

- Receiver and antenna quality and type--signal processing characteristics
- Receiver platform dynamics--static or dynamic
- Reference frames--satellite and user
- Geographic location of user--user latitude and longitude
- Satellite configuration relative to user
- Satellite characteristics--frequency stability and health
- Satellite constellation and service availability
- Satellite-User range determination accuracy
- Atmospheric conditions--signal propagation delays in ionosphere and troposphere
- Solar flux density--11-year solar cycle
- Observation length
- Multipath conditions at receiver
- Receiver noise
- Receiver mask angles
- Position computation solution algorithms

In general, there are two main components that determine the accuracy of a GPS position solution:

- Geometric Dilution of Precision (GDOP)
- User Equivalent Range Error (UERE)

GDOP is the geometric effect of the spatial relationship of the satellites relative to the user. In surveying terms, it is the "strength of figure" of the trilateration position computation. GDOP varies rapidly with time since the satellites are moving. UERE is the accuracy of the individual range measurement to each satellite. UERE also varies between different satellites, atmospheric conditions, and receivers. The absolute range accuracies obtainable from absolute GPS are largely dependent on which code (C/A or P-Code) is used to determine positions. These range accuracies (UERE), when coupled with the geometrical relationships of the satellites during the position determination (GDOP), result in a 3-D confidence ellipsoid that depicts uncertainties in all three coordinates. Given the continuously changing

satellite geometry, and other factors, GPS accuracy is time/location dependent. Error propagation techniques are used to define nominal accuracy statistics for a GPS user.

4-5. Positional Accuracy Statistics--Root Mean Square

Two-dimensional (2-D) horizontal GPS positional accuracies are normally estimated and reported using a root mean square (RMS) radial error statistic. RMS error measures are approximations to error ellipses that are computed for measured points. This RMS error statistic is related to (and derives from) the positional variance-covariance matrix, which is described more fully in Chapter 11. RMS statistics can have varying confidence levels. A $1\text{-}\sigma$ RMS error equates to the radius of a circle in which there is a 63% probability that the computed position is within this area. A circle of twice this radius (i.e. $2\text{-}\sigma$ RMS or 2DRMS) represents (approximately) a 98 percent positional probability circle. This 97 percent probability circle, or 2DRMS, is a common positional accuracy statistic used by GPS manufacturers. In some instances, a 3DRMS, or 99+ percent probability is used. The Federal Geographic Data Committee (FGDC) and the Corps of Engineers require horizontal and vertical geospatial accuracies to be reported at the 95% RMS confidence level. For all practical purposes, the 95% RMS and 2DRMS statistics are equivalent (Note also that a RMS error statistic represents the radius of a circle and therefore is not preceded by a \pm sign.)

a. Probable error measures. 3-D GPS accuracy measurements are sometimes expressed by Spherical Error Probable, or SEP. This measure represents the radius of a sphere with a 50% confidence or probability level. This spheroid radial measure only approximates the actual 3-D ellipsoid representing the uncertainties in the geocentric coordinate system. In 2-D horizontal positioning, a Circular Error Probable (CEP) statistic is commonly used, particular in military targeting. CEP represents the radius of a circle containing a 50% probability of position confidence.

b. Accuracy comparisons. It is important that GPS accuracy measures clearly identify the statistic from which they are derived. A "100-meter" or "3-meter" accuracy statistic is meaningless unless it is identified as being either 1-D, 2-D, or 3-D, along with the applicable probability or confidence level. For example, if a nominal SPS 2-D accuracy is specified as 7 meters CEP (i.e. 50%), then this equates to 15 meters at the 95% 2-D confidence level, and roughly 13.5 meters SEP (3-D 50%). See Table 4-1 for a comparison of the most commonly used error statistics. In addition, absolute GPS point positioning accuracies are defined relative to an earth-centered coordinate system/datum--WGS 84. This coordinate system may differ significantly from the user's local project or construction datum. Thus, any position derived from GPS observations is dependent on the accuracy of the reference datum/frame relative to WGS 84. Nominal GPS accuracies may also be published as design or tolerance limits and accuracies achieved can differ significantly from these values.

Table 4-1. Representative Statistics used in Geospatial Positioning

Error Measurement Statistic	Probability (%)	Relative Distance (s) ⁽¹⁾	Nominal SPS Point Positioning Accuracy meters ⁽²⁾	
			SN OR SE	SU
LINEAR MEASURES				
Probable Error	50	0.6745 σ	± 4 m	± 9 m
Average Error	57.51	0.7979 σ	± 5 m	± 11 m
One-Sigma Standard Error/Deviation	68.27	1.00 σ	± 6.3 m	± 13.8 m
90% Probability (Map Accuracy Standard)	90	1.645 σ	± 10 m	± 23 m
95% Probability/Confidence ⁽³⁾	95	1.96 σ	± 12 m	± 27 m
2-Sigma Standard Error/Deviation	95.45	2.00 σ	± 12.6 m	± 27.7 m
99% Probability/Confidence	99	2.576 σ	± 16 m	± 36 m
3-Sigma Standard Error (Near Certainty)	99.73	3.00 σ	± 19 m	± 42 m
TWO-DIMENSIONAL MEASURES			CIRCULAR RADIUS	
1-Sigma Standard Error Circle (σ_c) ⁽⁴⁾	39	1.00 σ_c	6 m	
Circular Error Probable (CEP) ⁽⁵⁾	50	1.177 σ_c	7 m	
1 Deviation Root Mean Square (1DRMS) ⁽⁶⁾	63	1.414 σ_c	9 m	
Circular Map Accuracy Standard	90	2.146 σ_c	13 m	
95% 2-D Positional Confidence Circle	95	2.447 σ_c	15 m	
2-Dev. Root Mean Square Error (2DRMS) ⁽⁷⁾	98 ⁺	2.83 σ_c	17.8 m	
99% 2-D Positional Confidence Circle	99	3.035 σ_c	19 m	
3.5 Sigma Circular Near-Certainty Error	99.78	3.5 σ_c	22 m	
3 Dev. Root Mean Square Error (3DRMS)	99.9 ⁺	4.24 σ_c	27 m	
THREE-DIMENSIONAL MEASURES			SPHERICAL RADIUS	
1- σ Spherical Standard Error (σ_s) ⁽⁸⁾	19.9	1.00 σ_s	9 m	
Spherical Error Probable (SEP) ⁽⁹⁾	50	1.54 σ_s	13.5 m	
Mean Radial Spherical Error (MRSE) ⁽¹⁰⁾	61	1.73 σ_s	16 m	
90% Spherical Accuracy Standard	90	2.50 σ_s	22 m	
95% 3-D Confidence Spheroid	95	2.70 σ_s	24 m	
99% 3-D Confidence Spheroid	99	3.37 σ_s	30 m	
Spherical Near-Certainty Error	99.89	4.00 σ_s	35 m	

NOTES:

MOST COMMONLY USED STATISTICS SHOWN IN BOLD
ESTIMATES NOT APPLICABLE TO DIFFERENTIAL GPS POSITIONING
CIRCULAR/SPHERICAL ERROR RADII DO NOT HAVE ± SIGNS

Absolute positional accuracies are derived from GPS simulated user range errors/deviations and resultant geocentric coordinate (X-Y-Z) solution covariance matrix, as transformed to a local datum (N-E-U or ϕ - λ -h). GPS accuracy will vary with GDOP, UERE, and other numerous factors at time(s) of observation. The 3-D covariance matrix yields an error ellipsoid. Transformed ellipsoidal dimensions given (i.e. σ_N - σ_E - σ_U) are only average values observed under nominal GDOP conditions. Circular (2-D) and spherical (3-D) radial measures are only approximations to this ellipsoid, as are probability estimates.

(Table 4-1 continued on next page)

Table 4-1. Representative Statistics used in Geospatial Positioning (continued)

- (1) Valid for 2-D & 3-D only if $\sigma_N = \sigma_E = \sigma_U$. ($\sigma_{\min}/\sigma_{\max}$) generally must be ≥ 0.2 . Relative distance used unless otherwise indicated.
- (2) Representative accuracy based on nominal (assumed) SPS 1-D accuracies shown in italics, and that $\sigma_N \approx \sigma_E$. SPS may have significant short-term variations from these nominal values. In table, $\sigma_N = \sigma_E = 6.3$ m and $\sigma_U = 13.8$ m.
- (3) FGDC reporting statistic for positions, elevations and depths, including USACE hydrographic survey position and depth measurement accuracy criteria.
- (4) $\sigma_c \approx 0.5 (\sigma_N + \sigma_E)$ -- approximates standard error ellipse
- (5) CEP $\approx 0.589 (\sigma_N + \sigma_E) \approx 1.18 \sigma_c$
- (6) 1DRMS $\approx (\sigma_N^2 + \sigma_E^2)^{1/2}$
- (7) 2DRMS $\approx 2 (\sigma_N^2 + \sigma_E^2)^{1/2}$
- (8) $\sigma_s \approx 0.333 (\sigma_N + \sigma_E + \sigma_U)$
- (9) SEP $\approx 0.513 (\sigma_N + \sigma_E + \sigma_U)$
- (10) MRSE $\approx (\sigma_N^2 + \sigma_E^2 + \sigma_U^2)^{1/2}$

Source: Topographic Engineering Center

4-6. GPS Range Error Budget

There are numerous sources of measurement error that influence GPS performance. The sum of all systematic errors or biases contributing to the measurement error is referred to as range bias. The observed GPS range, without removal of biases, is referred to as a biased range--i.e. the "pseudorange." Principal contributors to the final range error that also contribute to overall GPS error are ephemeris error, satellite clock and electronics inaccuracies, tropospheric and ionospheric refraction, atmospheric absorption, receiver noise, and multipath effects. Other errors may include those that were deliberately induced by DoD before 2000--Selective Availability (S/A), and Anti-Spoofing (A/S). In addition to these major errors, GPS also contains random observation errors, such as unexplainable and unpredictable time variation. These errors are impossible to model and correct. The following paragraphs discuss errors associated with absolute GPS positioning modes. Many of these errors are either eliminated or significantly minimized when GPS is used in a differential mode. This is due to the same errors being common to both receivers during simultaneous observing sessions. For a more detailed analysis of these errors, consult (DoD 2001) or one of the technical references listed in Appendix A.

a. Ephemeris errors and orbit perturbations. Satellite ephemeris errors are errors in the prediction of a satellite position which may then be transmitted to the user in the satellite data message. Typically these errors are less than 8 m (95%). Ephemeris errors are satellite dependent and very difficult to completely correct and compensate for because the many forces acting on the predicted orbit of a satellite are difficult to measure directly. Because direct measurement of all forces acting on a satellite orbit is difficult, it is nearly impossible to accurately account or compensate for those error sources when modeling the orbit of a satellite. Ephemeris errors produce equal error shifts in calculated absolute point positions. More accurate satellite orbit data can be obtained at later periods for post-processing; however, this is not practical for real-time point positioning applications.

b. Clock stability. GPS relies very heavily on accurate time measurements. GPS satellites carry rubidium and cesium time standards that are usually accurate to 1 part in 10^{12} and 1 part in 10^{13} , respectively, while most receiver clocks are actuated by a quartz standard accurate to 1 part in 10^8 . A time offset is the difference between the time as recorded by the satellite clock and that recorded by the receiver. Range error observed by the user as the result of time offsets between the satellite and receiver clock is a linear relationship and can be approximated by the following formula:

$$R_E = T_O \cdot c \quad (\text{Eq 4-7})$$

where

R_E = range error due to clock instability
 T_O = time offset
 c = speed of light

(1) The following example shows the calculation of the user equivalent range error (UERE)

$$T_O = 1 \text{ microsecond } (\mu\text{s}) = 10^{-6} \text{ seconds (s)}$$
$$c = 299,792,458 \text{ m/s}$$

From Equation 4-7:

$$R_E = (10^{-6} \text{ s}) * 299,792,458 \text{ m/s} = 299.79 \text{ m} = 300 \text{ m}$$

(2) In general, unpredictable transient situations that produce high-order departures in clock time can be ignored over short periods of time. Even though this may be the case, predictable time drift of the satellite clocks is closely monitored by the ground control stations. Through closely monitoring the time drift, the ground control stations are able to determine second-order polynomials which accurately model the time drift. The second-order polynomial determined by the ground control station to model the time drift is included in the broadcast message in an effort to keep this drift to within 1 millisecond (ms). The time synchronization between the GPS satellite clocks is kept to within 20 nanoseconds (ns) through the broadcast clock corrections as determined by the ground control stations and the synchronization of GPS standard time to the Universal Time Coordinated (UTC) to within 100 ns. Random time drifts are unpredictable, thereby making them impossible to model.

(3) GPS receiver clock errors can be modeled in a similar manner to GPS satellite clock errors. In addition to modeling the satellite clock errors and in an effort to remove them, an additional satellite should be observed during operation to simply solve for an extra clock offset parameter along with the required coordinate parameters. This procedure is based on the assumption that the clock bias is independent at each measurement epoch. Rigorous estimation of the clock terms is more important for point positioning than for differential positioning. Many of the clock terms cancel when the position equations are formed from the observations during a differential survey session.

c. Ionospheric delays. GPS signals are electromagnetic signals and as such are nonlinearly dispersed and refracted when transmitted through a highly charged environment like the ionosphere-- Figure 4-3. Dispersion and refraction of the GPS signal is referred to as an ionospheric range effect because dispersion and refraction of the signal results in an error in the GPS range value. Ionospheric range effects are frequency dependent.

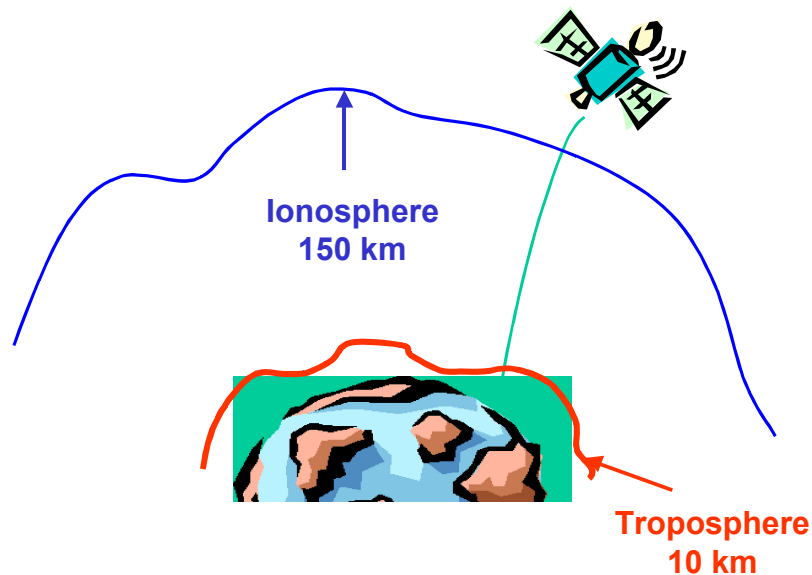

Figure 4-3. Atmospheric delays in received GPS signals

(1) The error effect of ionosphere refraction on the GPS range values is dependent on sunspot activity, time of day, and satellite geometry. Ionospheric delay can vary from 40-60 m during the day and 6-12 m at night. GPS operations conducted during periods of high sunspot activity or with satellites near the horizon produce range results with the most error. GPS operations conducted during periods of low sunspot activity, during the night, or with a satellite near the zenith produce range results with the least amount of ionospheric error.

(2) Resolution of ionospheric refraction can be accomplished by use of a dual-frequency receiver (a receiver that can simultaneously record both L1 and L2 frequency measurements). During a period of uninterrupted observation of the L1 and L2 signals, these signals can be continuously counted and differenced, and the ionospheric delay uncertainty can be reduced to less than 5 m. The resultant difference reflects the variable effects of the ionosphere delay on the GPS signal. Single-frequency receivers used in an absolute and differential positioning mode typically rely on ionospheric models that model the effects of the ionosphere. Recent efforts have shown that significant ionospheric delay removal can be achieved using dual-frequency receivers.

d. Tropospheric delays. GPS signals in the L-band level are not dispersed by the troposphere, but they are refracted due to moisture in the lower atmosphere. The tropospheric conditions causing refraction of the GPS signal can be modeled by measuring the dry and wet components. The dry component is best approximated by the following equation:

$$D_C = (2.27 \cdot 0.001) \cdot P_O \quad (\text{Eq 4-8})$$

where

D_C = dry term range contribution in zenith direction in meters

P_O = surface pressure in millibar (mb)

(1) The following example shows the calculation of average atmospheric pressure $P_0 = 1013.243$ mb:

From Equation 4-8:

$$\begin{aligned} D_c &= (2.27 \cdot 0.001) \cdot 1013.243 \text{ mb} \\ &= 2.3 \text{ m, the dry term range error contribution in the zenith direction} \end{aligned}$$

(2) The wet component is considerably more difficult to approximate because its approximation is dependent not just on surface conditions, but also on the atmospheric conditions (water vapor content, temperature, altitude, and angle of the signal path above the horizon) along the entire GPS signal path. As this is the case, there has not been a well-correlated model that approximates the wet component.

e. Multipath. Multipath describes an error affecting positioning that occurs when the signal arrives at the receiver from more than one path—see Figure 4-4. Multipath normally occurs near large reflective surfaces, such as a metal building or structure. GPS signals received as a result of multipath give inaccurate GPS positions when processed. With the newer receiver and antenna designs, and sound prior mission planning to reduce the possible causes of multipath, the effects of multipath as an error source can be minimized. Averaging of GPS signals over a period of time (i.e. different satellite configurations) can also help to reduce the effects of multipath.

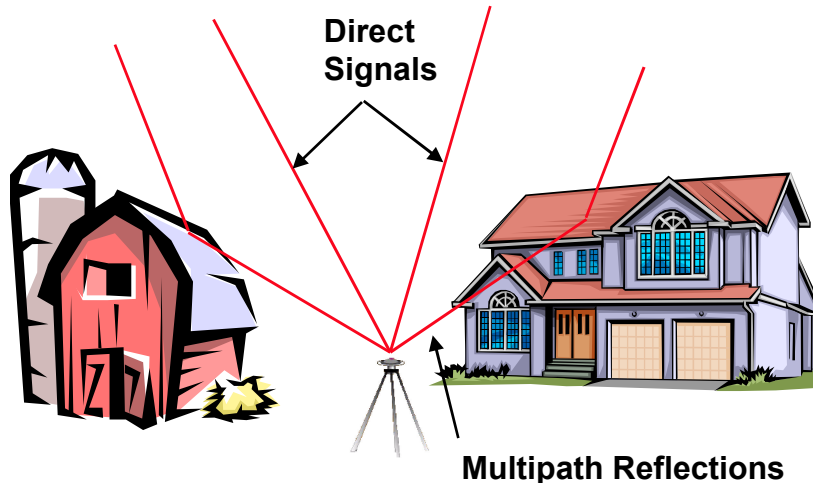

Figure 4-4. Multipath signals impacting GPS observations

f. Receiver noise. Receiver noise includes a variety of errors associated with the ability of the GPS receiver to measure a finite time difference. These include signal processing, clock/signal synchronization and correlation methods, receiver resolution, signal noise, and others.

g. *Selective Availability (S/A) and Anti-Spoofing (A/S)*. Before 2000, S/A was activated to purposely degrade the satellite signal to create position errors. This is done by dithering the satellite clock and offsetting the satellite orbits. Prior to 2000, the effects of S/A were eliminated by using differential techniques. DoD always reserves the right to reimplement S/A should a major military conflict require this action for national security. However, it is the stated intent of the US Government not to implement S/A globally but to develop regional GPS denial capabilities that will not impact GPS users globally. A/S is implemented by interchanging the P code with a classified Y code. This denies users who do not possess an authorized decryption device. Manufactures of civil GPS equipment have developed methods such as squaring or cross correlation in order to make use of the P code when it is encrypted.

4-7. User Equivalent Range Error

The previous sources of errors or biases are principal contributors to overall GPS range error. There are many others in the total error budget model. This total error budget is often summarized as the User Equivalent Range Error (URE), or as User Range Error (URE). To distinguish between the satellite-dependent errors and that of the user's receiver, a Signal-in-Space (SIS) URE is defined by (DoD 2001). This SIS URE does not include the receiver's noise and multipath effects. As mentioned previously, many of these range errors can be removed or at least effectively suppressed by developing models of their functional relationships in terms of various parameters that can be used as a corrective supplement for the basic GPS information. Differential techniques also eliminate many of these errors. Table 4-2 lists the more significant error sources for a single-frequency receiver, as observed globally by DoD on the given date. The resultant URE does not include multipath effects.

**Table 4-2. Estimate of Standard Positioning System User Range Error
Single Frequency Receiver (8 June 2000)**

Error Source	User Range Error Contribution (± meters)
Navigation Message Curve Fit	0.20
Tropospheric Model	0.25
C/A Code Phase Bias	0.27
Orbit	0.57
Receiver Noise	0.80
Satellite Clock	1.43
Ionospheric Model (global average)	7.00 ¹
URE (95%)	± 7.22 m

¹ Ionospheric model ranged from 1.30 m (best) to 7.00 m (worst)

Source: Figure A-5-12, (DoD 2001)

Globally, the URE for a single frequency ranged from 2.2 m to 14.6 m. A dual-frequency receiver had a far more accurate URE: 1.4 m to 2.3 m, with a global average of 1.7 m. If receiver multipath and other effects are added, say ± 2 to 4 m, then the UERE for a single-frequency receiver would be in the 10-15 m range.

4-8. Satellite Geometry Effects on Accuracy--Geometrical Dilution of Precision

The final positional accuracy of a point determined using absolute GPS survey techniques is directly related to the geometric strength of the configuration of satellites observed during the survey session. GPS errors resulting from satellite configuration geometry can be expressed in terms of GDOP. In mathematical terms, GDOP is a scalar, dimensionless quantity used in an expression of a ratio of the positioning accuracy. It is the ratio of the standard deviation of one coordinate to the measurement accuracy. GDOP represents the geometrical contribution of a certain scalar factor to the uncertainty (i.e. standard deviation) of a GPS measurement. GDOP values are a function of the diagonal elements of the covariance matrices of the adjusted parameters of the observed GPS signal and are used in the point formulations and determinations.

a. In a more practical sense, GDOP is a scalar quantity of the contribution of the configuration of satellite constellation geometry to the GPS accuracy, in other words, a measure of the "strength" of the geometry of the satellite configuration. In general, the more satellites that can be observed and used in the final solution, the better the solution. Since GDOP can be used as a measure of the geometrical strength, it can also be used to selectively choose four satellites in a particular constellation that will provide the best solution. Satellites spread around the horizon will provide the best horizontal position, but the weakest vertical elevation. Conversely, if all satellites are at high altitudes, then the precision of the horizontal solution drops but the vertical improves. This is illustrated in Figure 4-5. The smaller the GDOP, the more accurate the position.

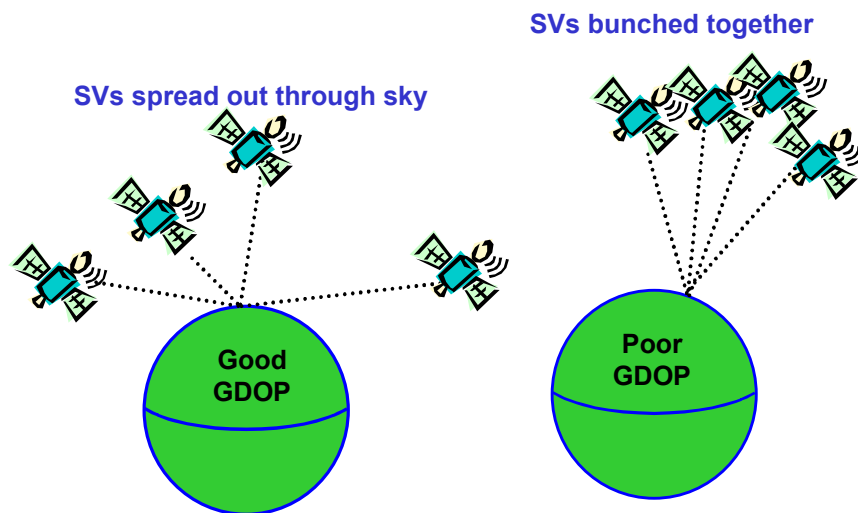

Figure 4-5. Satellite geometry and GDOP--"Good" GDOP and "Poor" GDOP configurations

b. GDOP values used in absolute GPS positioning is a measure of spatial accuracy of a 3-D position and time. The GDOP is constantly changing as the relative orientation and visibility of the

satellites change. GDOP can be computed in the GPS receivers in real-time, and can be used as a quality control indicator. GDOP is defined to be the square root of the sum of the variances of the position and time error estimates.

$$\text{GDOP} = [\sigma_E^2 + \sigma_N^2 + \sigma_U^2 + \sigma_R^2 + (c \cdot \delta_T)^2]^{0.5} \cdot [1 / \sigma_R] \quad (\text{Eq 4-9})$$

where

σ_E = standard deviation in east value, m

σ_N = standard deviation in north value, m

σ_U = standard deviation in up direction, m

c = speed of light (299,338,582.7 m/s)

δ_T = standard deviation in time, seconds

σ_R = overall standard deviation in range in meters, i.e. the UERE at the one-sigma (68%) level

The GDOP value is easily estimated by assuming the UEREs are all unity and then pulling the standard deviations directly from the variance-covariance matrix of the position adjustment. Thus GDOP (and its derivations) can be recomputed at each position update (e.g., every second). Large jumps (increases) in GDOP values are poor performance indicators, and typically occur as satellites are moved in and out of the solution.

c. Positional dilution of precision (PDOP). PDOP is a measure of the accuracy in 3-D position, mathematically defined as:

$$\text{PDOP} = [\sigma_E^2 + \sigma_N^2 + \sigma_U^2]^{0.5} \cdot [1 / \sigma_R] \quad (\text{Eq 4-10})$$

where all variables are equivalent to those used in Equation 4-9. PDOP is simply GDOP less the time bias.

(1) PDOP values are generally developed from satellite ephemerides prior to conducting a survey. When developed prior to a survey, PDOP can be used to determine the adequacy of a particular survey schedule.

(2) The key to understanding PDOP is to remember that it represents position recovery at an instant in time and is not representative of a whole session of time. When using pseudorange techniques, PDOP values in the range of 4-5 are considered very good, while PDOP values greater than 10 are considered very poor. For static surveys it is generally desirable to obtain GPS observations during a time of rapidly changing GDOP and/or PDOP.

(3) When the values of PDOP or GDOP are viewed over time, peak or high values (>10) can be associated with satellites in a constellation of poor geometry. The higher the PDOP or GDOP, the poorer the solution for that instant in time. This is critical in determining the acceptability of real-time navigation and photogrammetric solutions. Poor geometry can be the result of satellites being in the same plane, orbiting near each other, or at similar elevations.

d. Horizontal dilution of precision (HDOP). HDOP is a measurement of the accuracy in 2-D horizontal position, mathematically defined as:

$$\text{HDOP} = [\sigma_E^2 + \sigma_N^2]^{0.5} \cdot [1 / \sigma_R] \quad (\text{Eq 4-11})$$

This HDOP statistic is most important in evaluating GPS surveys intended for densifying horizontal control in a project. The HDOP is basically the RMS error determined from the final variance-covariance matrix divided by the standard error of the range measurements. HDOP roughly indicates the effects of satellite range geometry on a resultant position.

e. Vertical dilution of precision (VDOP). VDOP is a measurement of the accuracy in standard deviation in vertical height, mathematically defined as:

$$\text{VDOP} = [\sigma_U] \cdot [1 / \sigma_R] \quad (\text{Eq 4-12})$$

f. Acceptable DOP values. In general, GDOP and PDOP values should be less than 6 for a reliable solution. Optimally, they should be less than 5. GPS performance for HDOP is normally in the 2 to 3 range. VDOP is typically around 3 to 4. Increases above these levels may indicate less accurate positioning. In most cases, VDOP values will closely resemble PDOP values. It is also desirable to have a GDOP/PDOP that changes during the time of GPS survey session. The lower the GDOP/PDOP, the better the instantaneous point position solution is.

4-9. Resultant Positional Accuracy of Point Positioning

The relationship between positional solution, the range error, and DOP can be expressed as follows (Leick, 1995):

$$\text{Positional solution } (\sigma) = \sigma_R \cdot \text{DOP} \quad (\text{Eq 4-13})$$

where

σ = horizontal or vertical positional accuracy

σ_R = range error (95% UERE)

For example, if the observed HDOP of a point position is displayed as 2.0 assuming unity *a priori* deviations, and the estimated 95% UERE is 4 m, then the estimated horizontal positional accuracy would be 8 m. Since the UERE and HDOP (PDOP/HDOP/VDOP) values are so variable over short periods of time, there is little practical use in estimating a positional accuracy in this manner. Positional accuracy is best estimated by statistically comparing continuous observations at some known reference point, typically over a 24-hour period, and computing the 95% deviations.

a. From actual DoD worldwide observations, the results of actual horizontal and vertical positional accuracies of single- and dual-frequency GPS point positioning observed on two different dates are summarized in Table 4-3 below.

Table 4-3. GPS All-in-View Performance--95%

	Single Frequency		Dual Frequency	
	Horizontal m	Vertical m	Horizontal m	Vertical m
3 June 2000 ¹				
Global average	8.3	16.8	3.1	5.6
Worst site	19.7	44.0	5.0	9.2
8 June 2000 ¹				
Global average	7.8	16.2	2.6	4.3
Worst site	19.2	39.3	4.2	7.1
Predictable Accuracy ²	13	22	--	--
Worst case	36	77		

Sources:

1 Tables A-5-1 through A-5-4 (DoD 2001)

2 2001 Federal Radionavigation Plan/Systems Predicted Accuracy (FRS Table 3-1--GPS System Characteristics)

b. Table 4-3 shows that single-frequency receivers are capable of achieving around 10 m (95%) positional accuracy and that the vertical component is significantly poorer. The 2001 Federal Radionavigation Plan/System (FRP 2001) advertises a predictable SPS accuracy of 13 m (horizontal) and 22 m (vertical), with a global service availability of 99%. This predictable accuracy estimate does not include error contributions due to ionospheric contributions, tropospheric contributions, or receiver noise. There would be few applications for using GPS point positioning methods for elevation determination given the 20+ m error. The results also clearly show the accuracy improvements when dual-frequency receivers are used. There are many GIS database development applications where a horizontal accuracy in the 10 to 30 m range is sufficiently accurate; thus point positioning with a single- or dual-frequency receiver is a reliable, fast, and economical procedure for those applications. These point positioning accuracy levels are obviously not suitable for USACE design and construction purposes; thus, relative or differential positioning techniques are required.

Chapter 5 Differential or Relative Positioning Determination Concepts

5-1. General

Absolute point positioning, as discussed earlier, will not provide the accuracies needed for most USACE mapping and control projects due to existing and induced errors in the measurement process. In order to minimize these errors and obtain higher accuracies, GPS can be used in a relative or differential positioning mode--i.e. Differential GPS. Throughout this manual, the terms "relative" and "differential" positioning have similar meaning. This chapter covers the basic theory and concepts of differential GPS positioning as it applies to engineering and construction surveys.

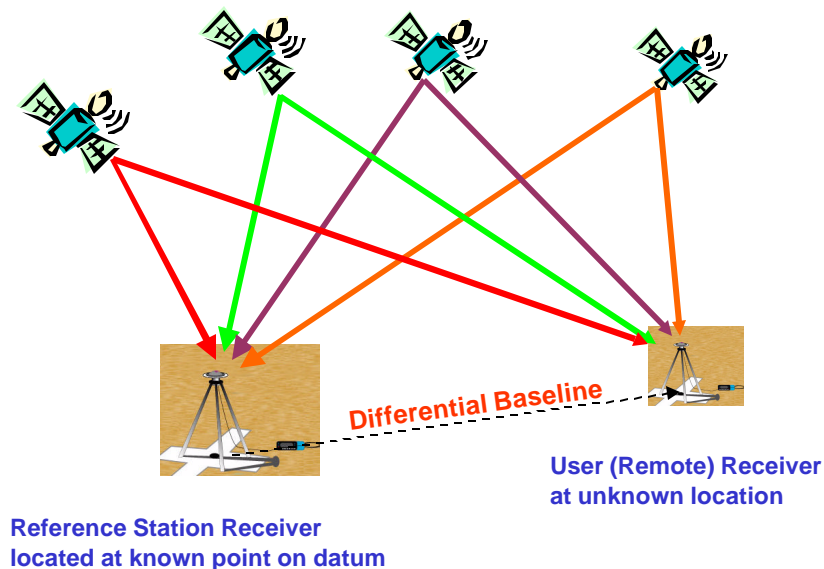

Figure 5-1. Differential or Relative GPS positioning

5-2. Differential Positioning Concepts

As stated in Chapter 2, differential GPS positioning is simply a process of determining the relative differences in coordinates between two receiver points, each of which is simultaneously observing/measuring satellite code ranges and/or carrier phases from the NAVSTAR GPS satellite constellation. These differential observations, in effect, derive a differential baseline vector between the two points, as illustrated in Figure 5-1. This method will position two stations relative to each other--hence the term "relative positioning"--and can provide the higher accuracies required for project control surveys, topographic surveys, and hydrographic surveys. There are basically two general types of differential positioning:

- Code phase pseudorange tracking
- Carrier phase tracking

Both methods, either directly or indirectly, determine the distance, or range, between a NAVSTAR GPS satellite and a ground-based receiver antenna. These measurements are made simultaneously at two different receiver stations. Either the satellite's carrier frequency phase, or the phase of a digital code modulated on the carrier phase, may be tracked--depending on the type of receiver. Through various processing techniques explained below, the distances between the satellites and receivers can be resolved, and the relative positions of the two receiver points are derived. From these relative observations, a baseline vector between the points is generated. The resultant positional accuracy is dependent on the tracking method used--carrier phase tracking being far more accurate than code phase tracking.

5-3. Differential Positioning (Code Pseudorange Tracking)

Code pseudorange tracking is the most widely used differential GPS positioning technique. It can deliver "meter-level" positional accuracies that typically range between 0.5 m to 5 m, depending on the code DGPS reference network and user receiver type. It is the technique used for maritime navigation, including USACE hydrographic surveying and dredge location applications. It is also used for air and land navigation where meter-level accuracy is required. Differential positioning using code pseudoranges is performed similarly to the Absolute Positioning techniques described in Chapter 4; however, some of the major clock error and atmospheric uncertainties are effectively minimized when simultaneous observations are made at two receiver stations. Errors in satellite range measurements are directly reflected in resultant coordinate errors. Differential positioning is not so concerned with the absolute position of the user but with the relative difference between two user positions who are simultaneously observing the same satellites. Since errors in the satellite position (X^s , Y^s , and Z^s) and atmospheric delay estimates (d) are effectively the same (i.e. highly correlated) at both receiving stations, they cancel each other to a large extent. Equation 4-1, which represents a general pseudorange observation, is repeated as Equation 5-1 below.

$$R = p^t + c(Dt) + d \quad (\text{Eq 5-1})$$

where

- R = observed pseudorange
- p^t = true range to satellite (unknown)
- c = velocity of propagation
- Dt = clock biases (receiver and satellite)
- d = propagation delays due to atmospheric conditions

The clock biases (Dt) and propagation delays (d) in the above equation are significantly minimized when code phase observations are made with two receivers. This allows for a relatively accurate pseudorange correction ($R - p^t$) to be computed at the receiver station set over a known point. This is because the true range (p^t) to the satellite can be determined from inverting between the ground station's coordinates and the broadcast satellite coordinates. If the pseudorange correction ($R - p^t$) is computed for 4 or more satellites, these pseudorange corrections can be transmitted to any number of user receivers to correct the raw pseudoranges originally observed. If 5 or more pseudorange corrections are observed, then a more reliable and redundant position computation is obtained. If more than one "reference station" is used to obtain pseudorange corrections, then the corrections may be further refined using the network of reference stations. Networks of stations transmitting differential GPS code correctors are termed as "augmented" GPS, or a wide area augmented system. Pseudorange corrections are broadcast by standard RF, satellite link, cell phone, or other transmission media. Satellite communications links are typically used for wide area augmentation networks. An alternate differential correction technique computes the position coordinate differences at the reference station and broadcasts these coordinate differences as correctors. This method is not widely used.

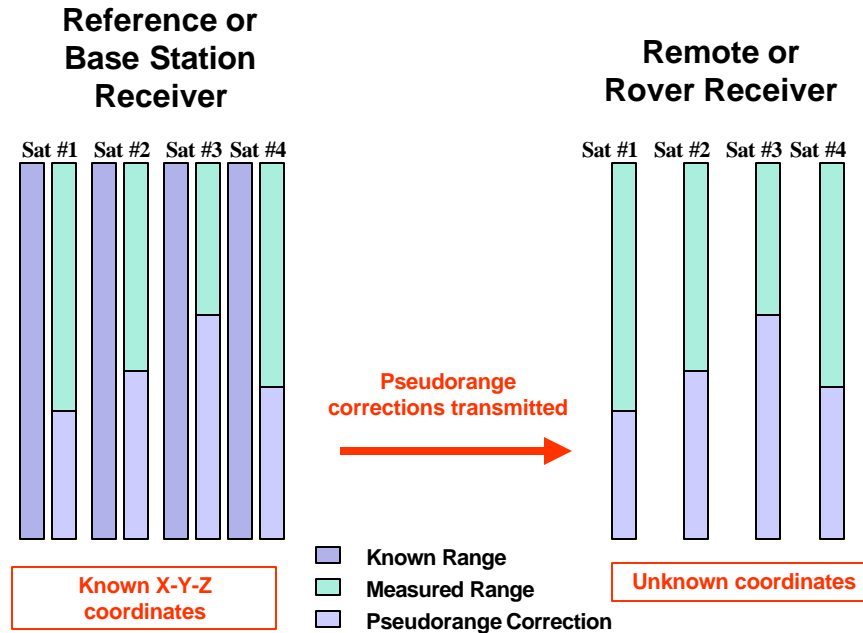

Figure 5-2. Determining pseudorange correction at a differential GPS reference station. Corrections are computed for satellites in view and broadcast to remote receivers.

a. For a simplified example, if the true range from a "known" GPS reference control point to a satellite is 20,000,000m and the observed or measured pseudorange distance was 19,999,992 m, then the pseudorange error or correction is + 8 m (20,000,000-19,999,992) for that particular satellite. A similar pseudorange correction (or PRC) can be generated for each satellite being observed from the known GPS reference station, as illustrated in Figure 5-2. If a second "rover" receiver is observing at least four of the same satellites as the reference receiver, and is within a reasonable distance (say 300 kilometers) from the reference receiver, it can use these same PRCs to correct the rover receiver's observed pseudoranges since the range errors will be similar at both points. If the rover receiver is located equidistant between two reference stations (i.e. a wide area GPS network), and the second reference station observed a PRC of + 10 m on the same satellite, then an adjusted PRC of 9 m $((8+10)/2)$ could be used at the rover receiver. Additional wide area reference stations provide better modeling of the PRCs at the rover receiver, although the density and distance from reference stations is still critical for accuracy improvements.

b. This differential code pseudoranging process results in coordinates of the user on the earth's surface that are relative to the datum of the reference station. For example, if the reference station is computing PRCs using NAD 83 (1996) coordinates, then the resolved coordinates at the rover receiver will be in this same system. These NAD 83 (1996) coordinates can be transformed to another datum and coordinate system (e.g., NAD 27 SPCS) using known local transformation differences, such as those obtained from CORPSCON. This is commonly done on Corps navigation projects that are still referenced to NAD 27. Code phase positions relative to an NAD 83 (1996) network (e.g., the USCG radiobeacon system) are converted back to NAD 27 for use in automated hydrographic survey data acquisition software. This is done in real-time. Therefore, GPS coordinate differences can be applied to any type of local project reference datum (i.e. NAD 27, NAD 83, or any local project grid reference system).

c. Code pseudorange tracking has primary application to real-time navigation systems where accuracies at the 0.5 to 5 m level are tolerable. Given these tolerances, USACE engineering survey applications for code pseudorange tracking GPS are hydrographic surveying, dredge positioning, and some GIS feature mapping work. Newer hand-held receivers capable of acquiring government or commercial wide area network PRCs will provide accuracies at the 5 to 10 m level, and can be used for populating GIS databases. Descriptions of real-time code phase tracking systems used for hydrographic surveying and dredge positioning are contained in EM 1110-2-1003.

5-4. Differential Positioning (Carrier Phase Tracking)

Differential positioning using carrier phase tracking uses a formulation of pseudoranges similar to that done in code or absolute GPS positioning. However, the process becomes somewhat more complex when the carrier signals are tracked such that range changes are measured by phase resolution. The modulated codes are removed from the carrier, and a phase tracking process is used to measure the differences in phase of the received satellite signals between the reference receiver and the user's receiver at an unknown point. The transmitted satellite signal is shifted in frequency due to the Doppler effect. The phase is not changed. GPS receivers measure what is termed the carrier phase "observable"--usually symbolized by " ϕ ". This observable represents the frequency difference between the satellite carrier and that generated in the receiver, or a so-called "beat" phase difference. This phase measurement observation can be shown in the following expression for the carrier phase observable (Kaplan 1996):

$$\mathbf{f}_k^P(t) = \mathbf{f}_k^P(t) - \mathbf{f}^P(t) + N_k^P + S_k + \frac{1}{f} \mathbf{t}_P + \frac{1}{f} \mathbf{t}_k - \mathbf{b}_{\text{iono}} + \mathbf{d}_{\text{tropo}} \quad (\text{Eq 5-2})$$

where

$$\begin{aligned} \mathbf{f}_k^P(t) &= \text{length of propagation path between satellite "P" and receiver "k" ... in cycles} \\ \mathbf{f}_k^P(t) &= \text{received phase of satellite "P" at receiver "k" at time "t"} \\ \mathbf{f}^P(t) &= \text{transmitted phase of satellite "P"} \\ N_k^P &= \text{integer ambiguity} \\ S_k &= \text{measurement noise (multipath, GPS receiver, etc.)} \\ \frac{1}{f} &= \text{carrier frequency (Hz)} \\ \mathbf{t}_P &= \text{satellite clock bias} \\ \mathbf{t}_k &= \text{receiver clock bias} \\ \mathbf{b}_{\text{iono}} &= \text{ionospheric advance (cycles)} \\ \mathbf{d}_{\text{tropo}} &= \text{tropospheric delay (cycles)} \end{aligned}$$

For more details on these carrier phase observation models, see also Remondi (1985), Leick (1995), Van Sickle (2001), and other texts listed at Appendix A.

a. Typically, two receivers will be involved in carrier phase observations, and 4 or more satellites will be measured from both receivers. One of the receivers will be placed at a known reference point--the "reference" receiver. The other receiver is usually referred to as the "remote" or "rover" receiver--and is located a point where a map feature or project control point coordinate is required. This "rover" receiver may be stationary over the unknown point--i.e. "static"--or it may be roving from unknown point to unknown point--i.e. "kinematic."

b. Interferometric "differencing" techniques are used to resolve carrier phase observations made at two receivers. Differencing involves forming linear combinations between phase observations. To

eliminate clock errors in the satellite, a "single difference" between phase measurements of the reference and remote receivers is performed. Single differencing between receivers eliminates the satellite clock error. This single differencing "between receivers" procedure is performed for all the mutually observed satellites, and the resultant single differences are subsequently differenced "between satellites" (i.e. "double differenced"), thus eliminating the receiver clock error. Double-differenced measurements on three pairs of satellites will yield the difference between the reference and remote locations. "Triple differencing" is the difference of two double differences performed over two different epochs. Triple differencing "between epochs" is used to indirectly resolve the number of whole carrier cycles between the satellite and receiver. There are a number of methods used to determine the integer ambiguity (the number of unknown integer cycles). These range from physical placement of the remote receiver a known distance from the reference receiver to automated Kalman filtering and searching methods. These differencing techniques are more fully described in Chapter 10.

5-5. Carrier Phase Survey Techniques

Carrier phase tracking provides an accurate satellite-receiver range resolution due to the short carrier wavelengths (approximately 19 cm for L1 and 24 cm for L2) and the ability of a receiver to resolve the carrier phase down to about 2 mm. This technique, therefore, has primary application to engineering, construction, topographic, and geodetic surveying, and may be employed using either static or kinematic methods. There are several techniques that use the carrier phase in order to determine the position of a remote receiver. These generally break down to static and kinematic methods; however, both methods have similar observation and initialization requirements, and differ mainly in their initialization procedures and whether the positional computations are performed in real-time or post-processed. In practice, some "kinematic" methods actually observe baselines in a "static" mode. Different receiver manufacturers have varying terminologies and techniques for these methods. The basic concepts of some of the most common survey techniques are explained below, and field procedures for some of these methods can be found in Chapter 9. Table 5-1 summarizes these techniques, their associated accuracies, applications, and required components.



Figure 5-3. (Left) GPS surveys at Corps Huntsville, AL Training Center--Survey IV PROSPECT Course (2002) and (right) New Orleans District GPS control surveys along Mississippi River at District Office base

a. Static. Static surveying (Figure 5-3) is the most widely used differential technique for precise control and geodetic surveying. It involves long observation times (30 minutes to 6+ hours, depending on the number of visible satellites, baseline length, accuracy, etc.) in order to resolve the integer ambiguities between the satellite and the receiver. Accuracies in the sub-centimeter range can be obtained using the static surveying methods. Either single-frequency or dual-frequency receivers may be used.

b. Rapid Static. The concept of Rapid Static is similar to Pseudo Kinematic described below. It is used to measure baselines and determine positions at the centimeter-level with short, static observation times--e.g., 5-20 minutes. The observation time is dependent on the length of the baseline and number of visible satellites. Loss of lock, when moving from one station to the next, can also occur since each baseline is processed independent of each other. Unlike Pseudo Kinematic, stations are occupied only once. Dual-frequency receivers are required.

c. Kinematic. Kinematic surveying is a GPS carrier phase surveying technique that allows the user to rapidly and accurately measure baselines while moving from one point to the next, stopping only briefly at the unknown points, or in dynamic motion such as a survey boat or aircraft. A reference receiver is set up at a known station and a remote, or rover, receiver traverses between the unknown points to be positioned. The data is collected and processed (either in real-time or post-time) to obtain accurate positions to the centimeter level. Kinematic survey techniques require some form of initialization to resolve the carrier phase ambiguities. This can be done by setting the remote receiver on a known baseline relative to the reference receiver, by performing an "antenna swap" procedure between the two receivers, and other techniques such as "On-the-Fly" or OTF.

d. Stop & Go Kinematic. Stop and Go Kinematic involves collecting static data for several minutes (i.e. 10-30 minutes) at each station after a period of initialization to gain the integers. This technique does not allow for loss of satellite lock during the survey. If loss of satellite lock does occur, a new period of initialization must take place. This method can be performed with two fixed or known stations in order to provide redundancy and improve accuracy.

e. Pseudo Kinematic. This technique is similar to Stop and Go Kinematic procedures. The main difference is that there is no static initialization. Unknown points must be double-occupied (approximately 5-10 minutes), and each unknown point must be revisited after about an hour. Unlike Stop and Go Kinematic, loss of satellite lock is acceptable.

f. Real-Time Kinematic (RTK). The RTK positioning methods will yield sub-decimeter accuracies in real-time. This method has become widely used for accurate engineering and construction surveys, including topographic site plan mapping, construction stake out, construction equipment location, and hydrographic surveying. This GPS technique determines the integer number of carrier wavelengths between the GPS antenna to the GPS satellite while the rover receiver is in motion and without static initialization. RTK typically uses an "On-the-Fly" (OTF) integer initialization process whereby initialization can be performed while the roving receiver is moving. Periodic loss of satellite lock can be tolerated and no static initialization is required to regain the integers. This differs from other GPS techniques that require static initialization while the user is stationary. A communication link between the reference and rover receivers is required. A number of techniques have been developed to increase RTK accuracies over local areas, such as placing simulated GPS satellite receivers at fixed ground locations (pseudolites). These have application in obscured areas (underground, tunnels, inside buildings, etc.) or for accurate aircraft landing elevation measurement.

Table 5-1. Carrier Phase Tracking Techniques

Concept	Minimum Requirements	Applications	Accuracy
Static (Post-processed)	L1 or L1/L2 GPS receiver 30 min to 1 hour minimum observation time	Control surveys (high-accuracy) Slow point positioning	Sub-centimeter
Rapid Static (Post-processed)	L1/L2 GPS receiver 5-20 min observation time Single occupation only No continuous satellite lock required	Control surveys (medium to high accuracy)	Sub-centimeter
Stop-and-Go Kinematic (Post-processed)	L1 GPS receiver Initialization required 1-2 minute baseline occupation Continuous satellite lock required	Control surveys (Medium accuracy) Fast point positioning	Centimeter +
Pseudo Kinematic (Post-processed)	L1 GPS receiver 5-10 minutes static observations Double occupations required between 1 and 4 hours No initialization required Loss of satellite lock permitted	Control surveys (Medium accuracy)	Few centimeters
Real-Time Kinematic (Real-time)	L1/L2 GPS Receiver Data-Link required Baselines should be < 10 km OTF initialization or conventional initialization Maintain satellite lock	Real-time hydro tides and heave corrections Location surveys Photo control (ABGPS) Real-time topo Construction stake out (Medium to high accuracy)	Centimeter +

5-6. Real-time Kinematic (RTK) GPS

The basic practical concept for real-time kinematic GPS surveying was developed in the early 1980's by Ben Remondi of the National Geodetic Survey. In 1989, the Corps' Topographic Engineering Center (ERDC/TEC) began development of algorithms to enable RTK observation of tides for hydrographic survey and dredge elevation corrections in offshore environments. Today, nearly all GPS receiver manufacturers provide RTK survey options for engineering, construction, and boundary surveying applications.

a. RTK equipment. A RTK carrier phase positioning system is very similar to code phase tracking technology described earlier. Two GPS receivers (reference and remote) are needed for RTK positioning. These receivers must meet the requirements to process real-time carrier phase tracking information. The user equipment on the ground, construction platform, survey vessel, or dredge typically consists of a geodetic-quality, dual-frequency, full wavelength L1/L2 tracking GPS receiver. The GPS reference station must be located over a known survey monument (a benchmark if precise elevation densification is being performed). The reference receiver must be capable of collecting both pseudorange and carrier phase data from the NAVSTAR satellites. A geodetic quality GPS antenna is required to minimize multipath. The

receivers should be capable of at least a 1-sec update rate. The processor used at the reference station will compute the pseudorange and carrier phase corrections and format the data for the communications link. The corrections will be formatted for transmission to the remote user; from which accurate, georeferenced coordinates are determined in real-time. As in code phase applications, the user datum must be correlated with the reference station datum, including accounting for geoid undulations that may occur between the stations. For hydrographic and dredging applications, the position output for the helmsman is code phase tracking using pseudoranges (accurate at the meter level)--for vessel navigation in real-time. The decimeter-level carrier phase DGPS data will be used to compute the vessel position and/or antenna elevation. The antenna elevation must be related to the water surface and vessel draft in order to reference GPS time-tagged depth soundings. GPS elevation data must also be transformed to the local reference datum--e.g., Mean Lower Low Water, Low Water Reference Plane.

b. Communications link. The communications link for a real-time carrier phase positioning system differs from the code phase tracking DGPS system in the amount of data that has to be transmitted. The carrier phase positioning system may require a minimum data rate of 4800 baud, as compared to a baud rate of 300 for the code phase tracking DGPS system. This high data rate eliminates many of the low-frequency broadcast systems and limits the coverage area for high-frequency broadcast systems. VHF and UHF frequency communications systems are well suited for this data rate, as are satellite links. Frequency approval may be necessary for communication link broadcasts using a power source in excess of 1 watt. RTK is rarely used for surveys in excess of 20 km from the reference station.

5-7. Differential GPS Error Sources

The error sources encountered in the position determination using differential GPS positioning techniques are the same as those outlined for Absolute Positioning in Chapter 4. However, many of the errors inherent in Absolute Positioning are effectively minimized when differential code or carrier tracking techniques are employed--especially when short baseline distances are observed with high-quality dual-frequency receivers. The errors that are minimized or eliminated include:

- Selective Availability (S/A). When S/A was activated prior to 2000, differential positioning techniques eliminated this intentionally induced error.
- Ionospheric and Tropospheric Delays. When the reference and remote stations are close together, these atmospheric delays are effectively eliminated. However as distance between the differential receivers increases, these delays can become significant. For example, USCG code tracking radiobeacon systems are fairly accurate out to about 150 km. Beyond that distance, differing atmospheric conditions add to the range errors. In some cases, localized weather patterns at even shorter distances can effect the code tracking measurements.
- Ephemeris Error. Ephemeris errors are significantly reduced with differential techniques. Processing baseline data with a precise ephemeris will further reduce this error.
- Satellite Clock Error. Compensated as long as both the reference and remote differential receivers use the same satellite clock correction data.

Table 5-2 below shows the nominal range error budget for a differential code phase tracking system where the common error sources from the space and control segments have been eliminated.

Table 5-2. Error Budget for Differential Positioning Systems (Code Phase)

Segment Source	Error	User Range Error Contributions (± meters)	
		Near	Far (>350 km)
Space	Clock and NAV subsystem stability	0.0	0.0
	Predictability of SV perturbations	0.0	0.0
	Other	1.0	1.0
Control	Ephemeris prediction model implementation	0.0	0.0
	Other	1.8	1.8
User (P(Y)-Code)	Ionospheric delay compensation	0.0	4.5
	Tropospheric delay compensation	0.0	3.9
	Receiver noise and resolution	4.1	4.1
	Multipath	3.4	3.4
	Other	1.0	1.0
UERE (95%)		5.8	8.3

Source: Table 10-1, (DoD 1996)

In addition to these error sources, the user must ensure that the receiver maintains lock on at least three satellites for 2-D positioning, four satellites for 3-D positioning, and five or more satellites when RTK methods are employed. In performing carrier phase GPS static surveys, if lock is not maintained, positional results may be degraded, resulting in incorrect formulations. When loss of lock occurs, a cycle slip (a discontinuity of an integer number of cycles in the measured carrier beat phase as recorded by the receiver) may occur. Sometimes, in static GPS control surveying, if the observation period is long enough, post-processing software may be able to average out loss of lock and cycle slips over the duration of the observation period and formulate positional results that are adequate. If this is not the case, reoccupation of the stations may be required. In all differential surveying techniques, if loss of lock does occur on some of the satellites, data processing can continue easily if a minimum of four satellites have been tracked. Generally, the more satellites tracked by the receiver, the more insensitive the receiver is to loss of lock. In general, cycle slips can be repaired.

5-8. Differential GPS Accuracies

There are two levels of accuracies obtainable from GPS using differential techniques. The first level is based on pseudorange code formulations, while the other is based on carrier phase formulations. All accuracy assessments are highly dependent on the type and quality of the GPS receivers used--see *Global Positioning System Standard Positioning Service Performance Standard* (DoD 2001).

a. Pseudorange code accuracies. Pseudorange formulations can be developed from either the C/A-code or the more precise P-code. Pseudorange accuracies are generally accepted to be 1 percent of the period between successive code epochs. Use of the P-code where successive epochs are 0.1 microsecond apart produces results that are around 1 % of 0.1 microsecond, or 1 ns. Multiplying this value by the speed of light gives a theoretical resultant range measurement of around 30 cm. If using pseudorange formulations with the C/A-code, one can expect results ten times less precise or a range measurement precision of around 2 to 3 m. (Note that the DoD only commits to providing

$a \leq 6$ m UERE; however, PPS Signal-in-Space UEREs have been consistently less than 2 m--see Chapter 4 and DoD 2001). Point positioning accuracy for a differential pseudorange formulated solution is generally found to be in the range of 0.5 m to 5 m at the 95% confidence level. Sub-meter accuracy is easily achievable if code tracking receiver distances are short, e.g., less than 50 km, and PDOP is < 5 . As always, these accuracy estimates are largely dependent on the type of GPS receivers being used and the distance from the reference station.

b. Carrier phase formulations. Carrier phase formulations can be based on the L1, L2, or both carrier signals. Accuracies achievable using carrier phase measurement are generally accepted to be 1 % of the wavelength. Using the L1 frequency where the wavelength is around 19 cm, one can expect a theoretical resultant range measurement that is 1 % of 19 cm, or about 2 mm. The L2 carrier can only be used with receivers that employ cross-correlation, squaring, or some other technique to get around the effects of A/S. Some of the factors that enter into the error budget of a differential carrier phase solution are:

- Distance between reference and remote station.
- Receiver quality. Low-end, inexpensive hand-held or geodetic quality--usually directly related to receiver cost which can range from \$100 to \$20,000 or more.
- Receiver signal processing methods.
- Single or dual-frequency tracking. L1 C/A-code, L1 P-code, L2 P-code, and/or L2 Y-code.
- Number of satellites receiver can track. Varies from 1 to "all-in-view." Less expensive, hand-held receivers typically track only 8 satellites. Most high-end geodetic quality receivers can track up to 12 or 24 satellites. Some receivers also track GLONASS satellites.
- Satellite tracking channels in receiver. Varies from 1 to 40--12 channels being typical.
- Baseline reduction and analysis methods. Also relates to number of epochs observed or length of observation--e.g., 1-hour or 6-hour static baseline observation.
- Real-time kinematic or post-processing solution.
- Integer ambiguity solution techniques.
- Antenna design.
- Redundant observations. Redundant baseline observations and connections from different network points will improve the computed positional accuracy of a point when the observations are processed through standard geodetic network adjustment routines.

The final positional accuracy of a point (or the derived baseline vector between two points) determined using differential carrier phase GPS survey techniques is directly related to the geometric strength of the configuration of satellites observed during the survey session. GPS errors resulting from satellite configuration geometry can be expressed in terms of DOP. Positional accuracy for a differential carrier phase baseline solution is generally found to be in the range of 1-10 mm. On extremely short baselines used for structural deformation monitoring surveys (i.e. less than 1,000 m) accuracies at the 1 mm level are typically observed. Elevation difference accuracies tend to be larger--around the 5 mm level over short baselines. Real-time dynamic GPS measurements have even larger accuracy estimates due to velocities of the moving platform.

c. Accuracy estimates for differential GPS systems. The resultant accuracy of a differential carrier phase baseline solution is widely variable and depends on the factors listed in the above paragraphs. In addition, accuracies are difficult to quantify, given the variety of GPS receivers. Many organizations have performed independent testing of GPS receivers; however, these tests are often dated and may not be representative of "real-world" observing conditions. Likewise, receiver manufacturer's claimed accuracies are subject to unknown observing conditions and caveats--often similar grade receivers have widely varying accuracy claims by different manufacturers. Typically, code tracking

receivers report positional accuracies as 2-D horizontal RMS statistics. Carrier tracking accuracies are usually reported as a function of the baseline distance, which includes both a fixed quantity and a parts per million (ppm) ratio of the baseline length. Accuracy estimates can also be indirectly derived from the results of network adjustments or comparisons with higher-accuracy baselines. The general accuracy values shown in Table 5-3 below are based on such comparisons and are believed to be representative of the current technology. In some cases, resultant horizontal and vertical accuracies can only be estimated because there is no independent method to accurately verify the data, e.g., offshore sea level or tidal elevation measurements using RTK techniques.

Table 5-3. Nominal Positional or Baseline Accuracies for Differential Positioning Systems (Single baseline observation)

GPS Receiver or Tracking System	Estimated Accuracy (95%)	
	Code	Carrier
Low-cost resource grade receivers (L1 only) Baselines < 100 km	3 to 5 m	n/a
Geodetic-quality 24 channel, L1-L2 (Static long-term baseline observations)		
Short baseline length (< 1 km)	0.3 to 1 m	2 mm±1 ppm
Baseline length < 10 km	0.3 to 1 m	5 to 10 mm±1 ppm
Baseline length < 100 km	1 m	n/a
Baseline length < 500 km	> 1 m	n/a
USCG radiobeacon receivers		
Short baseline length (< 1 km)	0.3 to 1 m	n/a
Baseline length < 10 km	0.3 to 1 m	n/a
Baseline length < 100 km	1 to 2 m	n/a
Baseline length < 500 km	3 to 10 m	n/a
World-wide wide-area networks with atmospheric modeling	0.5 to 2 m	n/a
Real-time Kinematic Observations with Geodetic-quality receiver (baselines less than 10 km)		
Horizontal position accuracy	n/a	10 to 30 mm
Vertical accuracy	n/a	30 to 100 mm
Adjusted positional accuracy using multiple CORS stations		
Horizontal	n/a	10-20 mm
Vertical	n/a	100 mm
Real-time Kinematic offshore tidal & heave modeling	n/a	100 mm

5-9. Differential GPS Augmentation Systems

A number of differential GPS augmentation systems are available from both government and commercial sources. Most real-time augmentation systems are code tracking. However, more emphasis is being placed on developing accurate carrier tracking augmentation networks. The following material on Federal augmentation systems is extracted from the *2001 Federal Radio Navigation Plan* (FRP 2001). Description of some commercial augmentation systems is covered in later chapters.

a. Maritime Differential GPS (MDGPS). The USCG Maritime DGPS Service provides terrain-penetrating medium-frequency signals, optimized for surface applications, for coastal coverage of the continental US, the Great Lakes, Puerto Rico, portions of Alaska and Hawaii, and portions of the Mississippi River Basin. Maritime DGPS uses fixed GPS reference stations that broadcast pseudorange corrections and provide GPS integrity information using radionavigation beacons. The Maritime DGPS Service provides radionavigation accuracy better than 10 meters (95% RMS) for US harbor entrance and approach areas. The system is operated to International Telecommunications Union and Radio Technical Commission for Maritime Services (RTCM) standards and has been implemented by more than 40 other maritime nations. The USCG declared FOC of the Maritime DGPS Service on March 15, 1999. Steps are being taken to include DGPS as a system that meets the carriage requirements of the Navigation Safety Regulations (33 CFR 164), for vessels operating on the navigable waters of the US.

b. Nationwide Differential GPS (NDGPS). A Nationwide DGPS (NDGPS) Service is being established under the authority of Section 346 of the Department of Transportation and Related Agencies Appropriation Act, 1998 PL 105-66 U.S.C. 301. This service is an expansion of the MDGPS to cover areas of the country where service from MDGPS is not available. When complete, this service will provide uniform differential GPS coverage of the continental US and selected portions of Hawaii and Alaska regardless of terrain, man made, and other surface obstructions. This is achieved by using a terrain-penetrating medium-frequency signal optimized for surface application. This service, along with MDGPS, provides a highly reliable GPS integrity function to terrestrial and maritime users. NDGPS accuracy is specified to be 10 meters or better. Typical system performance is better than 1 m in the vicinity of the broadcast site. Achievable accuracy degrades at an approximate rate of 1 m for each 150 km distance from the broadcast site. When each site is brought online, it meets all FOC requirements as set forth by the USCG for their MDGPS service. This includes integrity, availability, and accuracy. The NDGPS Service will achieve FOC when it provides dual coverage of the continental US and selected portions of Hawaii and Alaska with single coverage elsewhere. Given the current funding environment, FOC is expected by the end of calendar year 2007. The service is operated to the RTCM SC-104 broadcast standard. This standard has also been adopted by the international community as ITU-R 823 and has been implemented in over 40 countries, maritime and non-maritime, worldwide.

c. FAA Wide Area Augmentation System (WAAS). The FAA is developing the WAAS to augment GPS. WAAS is designed primarily for aviation users. The WAAS provides a signal-in-space to enable WAAS users to navigate the en route through precision approach phases of flight. The signal-in-space provides three services: (1) integrity data on GPS and Geostationary Earth Orbit (GEO) satellites, (2) differential corrections of GPS and GEO satellites to improve accuracy, and (3) a ranging capability to improve availability and continuity. The FAA announced in August 2000 that WAAS is continuously broadcasting differential corrections and is available for non-safety applications. WAAS initial operational capability for safety applications (as a supplemental means of navigation), expected in 2003, will support en route through approach with vertical guidance operations. The long-term plans for navigation architecture are based on a WAAS primary means of navigation determination in 2009. To that end, as well as to improve performance, a key recommendation is to utilize the new GPS civil signal at L5 (1176.45 MHz) when it is available to provide a more robust, interference resistant, and available service to users equipped with L5 receivers. The result of these incremental improvements will enable aircraft equipped with WAAS avionics to execute all phases of flight except Category II and III precision approaches.

d. FAA Local Area Augmentation System (LAAS). LAAS augments GPS by providing differential corrections to users via a VHF data broadcast. Suitably equipped aircraft will be able to conduct precision approaches at airfields where LAAS Category I ground facilities are installed. Category I LAAS is currently in development with installation of the first of 46 federal systems expected

in 2003. Research and specification development are currently underway to support Category II and III LAAS. The first public use Category II and III LAAS system is planned in 2006.

e. The National Continuously Operating Reference Station (CORS) System. The National Geodetic Survey is establishing a national CORS system to support non-navigation, post-processing applications of GPS. The national CORS system provides code range and carrier phase data from a nationwide network of GPS stations for access by the Internet. As of October 2001, data were being provided from about 232 stations.

Chapter 6 GPS Applications in USACE

6-1. General

This chapter outlines some of the varied uses of GPS by USACE surveyors and its contractors. GPS applications apply to all the Corps' civil works, military construction, and environmental missions. These applications include real estate surveys, regulatory enforcement actions, horizontal and vertical control densification, structural deformation studies, airborne photogrammetry, dynamic positioning and navigation for hydrographic survey vessels and dredges, hydraulic study/survey location, river/flood plain cross-section location, core drilling location, environmental studies, emergency operations, levee overbank surveys, and levee profiling. Construction uses of real-time GPS include levee grading and revetment placement, disposal area construction, stakeout, etc. Additionally, GPS has application in developing various levels of Geographic Information System (GIS) spatial data, such as site plan topography, facilities, utilities, etc. In effect, GPS has application for any USACE project requiring georeferenced spatial data. Given the variety of GPS accuracies and operating modes, a particular project application may involve one or more types of equipment and data acquisition methods. Suggested GPS techniques are shown in Table 6-1 for different types of Corps projects.

Table 6-1. Summary of Typical GPS Applications on USACE Civil and Military Construction Projects

USACE Project/Functional Application	Absolute GPS 10 to 30 m	Code Differential GPS 0.5 to 3 m	Carrier DGPS 1 to 10 cm
General Project Mapping Control (Military & Civil)			
Reference benchmark elevations			Static PP
Reference horizontal positions			Static PP
Facility Mapping (Site Plans & GIS)			
Building & structure location			RTK or PPK
Utility location			RTK or PPK
Roads, streets, airfields, etc.			RTK or PPK
Grading & Excavation Plans			RTK or PPK
Recreational Plans			RTK or PPK
Training Range Plans		RT	
Airfield obstruction mapping		RT	
Training range mapping/location	RT or	RT	
Utility Location & As-Builts		RT or	RTK
Environmental Mapping		RT or	RTK
Flood Control Projects			
Floodplain Mapping	RT or	RT	
Soil/Geology Classification Maps	RT or	RT	
Cultural/Economic Classifications	RT or	RT	
Land Utilization Mapping	RT or	RT	
Wetland/Vegetation Delineation	RT or	RT	
Levee Profiling			RTK

Table 6-1 (Contd). Summary of Typical GPS Applications on USACE Civil and Military Construction Projects

USACE Project/Functional Application	Absolute GPS 10 to 30 m	Code Differential GPS 0.5 to 3 m	Carrier DGPS 1 to 10 cm
Navigation Projects			
Primary Project Control Surveys			Static PP
Dredge Control:			
Horizontal position		RT	
Disposal area monitoring		RT	
Vertical reference			RTK
Hydrographic Survey Control:			
Project condition		RT	
Measurement & payment		RT	
Accurate tidal monitoring			RTK
General Vessel Navigation	RT		
Shoreline Mapping		RT or	RTK
MHW line Delineation			RTK
Hydraulic & Hydrology Studies			
Horizontal reference	RT or	RT	
Vertical reference			RTK or Static PP
Geotechnical Investigations			
Boring location (horizontal)	RT or	RT	
Boring reference elevation			RTK or Static PP
Structural Deformation Surveys			
Network monitoring points			Static PP
Periodic monitoring surveys			Static PP
Continuous deformation monitoring			RTK or PPK
Construction			
Layout and alignment			Static PP or RTK
Material placement (horizontal)		RT or	RTK
Placement & grading (vertical)			RTK
Coastal Engineering			
Primary Baseline Control			Static PP or RTK
Dune/Beach Topo Sections			RTK
Photogrammetric Mapping			
Camera/LIDAR positioning (ABGPS)			PPK
Ground control surveys			Static PP
Emergency Operations			
Personnel location	RT		
Facility location	RT	RT	
Real Estate			
Tract, Plat & Parcel Mapping			RTK
Boundary Monuments			Static PP or RTK
Condemnation Maps			RTK
General Location Maps		RT	
HTRW Site Control & Mapping			
Site Plan Control			Static PP
Geotoxic Data Mapping/Modeling		RT or	RTK

RT: Real-time RTK: Real-time Kinematic PP: Post-processed PPK: Post-Processed Kinematic

6-2. Project Control Densification

Establishing or densifying primary project control is one of the major uses of GPS technology. GPS is often more cost-effective, faster, accurate, and reliable than conventional (terrestrial) survey methods. The quality control statistics and large number of redundant measurements in GPS networks help to ensure reliable results. Primary horizontal and vertical control monuments are usually set using static GPS survey methods, although some post-processed kinematic methods may also be employed. These primary monuments are typically connected to NGRS horizontal and vertical reference datums. From these primary monuments, supplemental site plan mapping or vessel/aircraft positioning is performed using RTK techniques. Field operations to perform a GPS static control survey are relatively efficient and can generally be performed by one person per receiver. GPS is particularly effective for establishing primary control networks as compared with conventional surveys because intervisibility is not required between adjacent stations. Figure 6-1 below shows a portion of a GPS project planning network for static GPS control surveys along the Mississippi River in Memphis District. Other examples of typical USACE project control surveys are found in the appendices to this manual. These include setting control for a navigation project, a flood control project, and a dam deformation monitoring reference network.

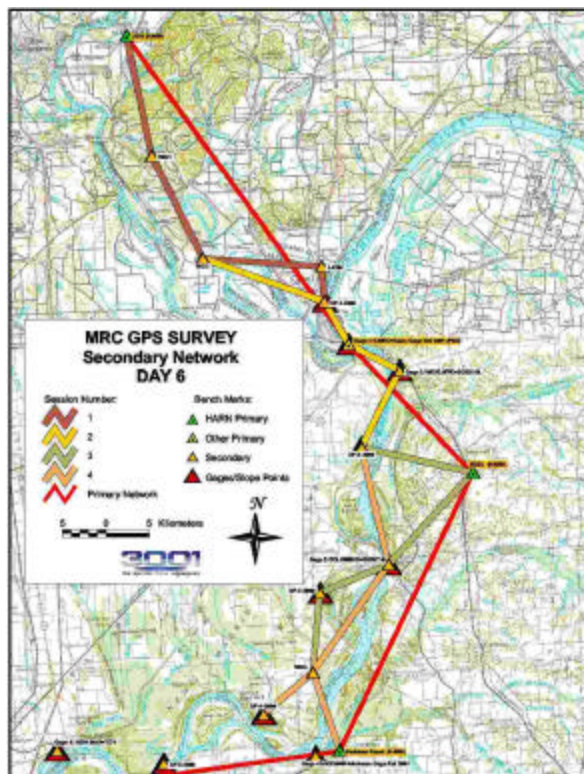

Figure 6-1. Control survey observing scheme on Mississippi River and control point baseline occupation at Memphis District Ensley Boatyard (Memphis District and 3001, Inc.)

6-3. Facility Site Plan Topographic Mapping and GIS Surveys

Real-time and post-processed techniques can be used to perform topographic mapping surveys and GIS base mapping. Depending on the accuracy, either code or carrier phase techniques may be employed--see Table 6-1. In general, most topographic mapping is performed using real-time kinematic methods using carrier phase accuracy. Post-processed fast-static methods may be used to set temporary mapping control or aerial mapping targets. Figure 6-2 below depicts equipment used on a typical fast-static survey at the Corps' Huntsville, AL training center. Real-time topographic or GIS feature data is usually collected from portable range pole or backpack antenna mounts, as shown in Figure 6-3. Data are logged on standard data collectors similar to those used for terrestrial total stations. Data collector software is designed to assign topographic and GIS mapping features and attributes, and to perform standard construction stakeouts. Code differential techniques may be used for GIS mapping features requiring only meter-level accuracy. If only approximate mapping accuracy is needed, hand-held GPS receivers with absolute (10-30 m) positioning may be used.



Figure 6-2. Fast-Static control survey of topographic reference monument at Huntsville Bevill Center



Figure 6-3. GPS real-time kinematic topographic surveys using backpack and range pole antenna mount

6-4. Shallow Wetland Mapping

Carrier and code differential GPS can be employed for surveys of shallow wetland areas. These GPS techniques are significantly more effective and accurate than terrestrial methods in these inaccessible areas. Real-time kinematic methods can provide decimeter-level (or better) elevation accuracies, which are critical in flat, low-flow areas. GPS topographic shot points can be observed in clear areas to minimize vegetation clearing in environmentally sensitive areas. These data points can then be input into a terrain model of the area. GPS equipment can be mounted on airboats, swamp tractors, or other platforms, as shown in Figure 6-4 below. Higher antenna pole mounts may be needed to reach over taller grass.



Figure 6-4. GPS RTK surveys from airboat operating in shallow wetland areas (Jacksonville District)

6-5. Flood Control Projects--Levee Assessments

Post-processed or real-time kinematic methods may be used to rapidly measure levee profile elevations, using platforms such as those shown in Figure 6-5. Similar RTK methods may be used to run levee cross-sections at selected intervals along the levee baseline--eliminating the need to stakeout individual hubs on the baseline. These "overbank" sections can also be extended into the water for hydrographic depth measurement, with the RTK system providing the reference elevation.



Figure 6-5. New Orleans District levee profiling using real-time kinematic GPS methods (New Orleans District and 3001, Inc.)

6-6. Navigation Project Survey Vessel and Dredge Control

Both code and carrier phase DGPS methods are used to control most in-house and contracted dredging and surveying operations on Corps navigation projects. Code-phase differential GPS is typically used for dynamic, meter-level accuracy positioning of survey boats and dredges. Centimeter-level accuracy carrier phase differential GPS is used for real-time tidal or river stage modeling during hydrographic surveys. The following figures (6-6 through 6-8) are representative of Corps platforms utilizing code and carrier phase GPS navigation and positioning. For details on marine platform positioning, refer to EM 1110-2-1003 (Hydrographic Surveying).



Figure 6-6. Typical USCG Maritime DGPS controlled Corps hopper dredge at Southwest Pass, LA (New Orleans District)



Figure 6-7. Typical Corps hydrographic survey vessel equipped with carrier phase DGPS and IMU for measuring vessel position, roll, pitch, and heave parameters during real-time surveys (New York District)

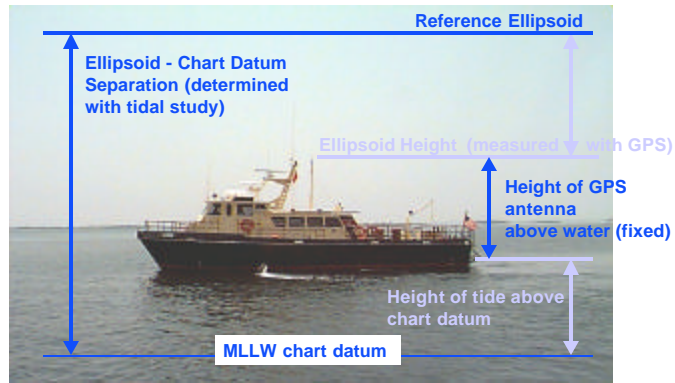

SB Florida, Jacksonville District

Figure 6-8. Use of carrier phase DGPS for real-time modeling offshore tides at Kings Bay FBM Entrance Channel (Jacksonville District and ERDC Topographic Engineering Center)

6-7. Hydraulic and Hydrology Studies

River hydraulic measurements and studies can be positioned using meter-level code phase techniques. RTK methods can be used if accurate cross-sections are required. Overbank and flood plain topography can be obtained from a variety of terrestrial and airborne survey methods--all controlled using DGPS. A typical Corps survey boat designed to obtain river hydraulic and hydrologic data is shown in Figure 6-9 below. This vessel is capable of obtaining acoustic topographic elevation models of the riverbed, Doppler current data, and sub-bottom material classification. These datasets are georeferenced using either real-time code or kinematic GPS observations aboard the boat.



Figure 6-9. St. Louis District hydraulics and hydrology survey boat

6-8. Structural Deformation Surveys

GPS survey techniques can be used to monitor the motion of points on a structure relative to stable reference monuments. This can be done with an array of antennae positioned at selected points on the structure and on the reference monuments. Baselines are formulated between the occupied points to monitor differential movement. Given the typically short baselines (< 500 m), the relative precision of the measurements is on the order of 2 to 5 mm. Measurements can be made on a continuous basis. A GPS structural deformation system can operate unattended and is relatively easily installed and maintained. Alternatively, periodic monitoring observations are taken using RTK or post-processed kinematic techniques, as illustrated in Figure 6-10. Prior to performing structural monitoring surveys, the stable reference network must be accurately positioned. Long-term static GPS observations are typically used to perform this task. Detailed procedures on these surveys are covered in EM 1110-2-1009 (Structural Deformation Surveying).



Figure 6-10. Real-time kinematic structural deformation surveys of locks and dams--St. Lucie Lock (Jacksonville District and Arc Surveying & Mapping, Inc.)

6-9. Construction Stakeout and Grading

Survey-grade GPS receivers are now designed to perform all traditional construction stakeouts--e.g., lots, roads, curves, grades, etc. Typical Corps applications include staking out baselines for beach renourishment projects, levee baselines, boring rig placement, and facility or utility construction alignment. An example stakeout survey for a beach renourishment construction baseline is found in an appendix to this manual. GPS can also be used to control and monitor earth-moving operations, such as grading levees or beach construction--Figure 6-11. For further information on typical construction stakeout and laser alignment techniques with GPS, see *Trimble Survey Controller Reference Manual/Field Guide* (Trimble 2001a).



Figure 6-11. Construction grading and core drill location GPS applications

6-10. Coastal Engineering Surveys

Differential GPS positioning and elevation measurement techniques have almost replaced conventional survey methods in performing beach surveys and studies. Depth measurement sensors (physical or acoustical) are typically positioned with RTK methods. DGPS is used to control the "sounding rod" attached to the "CRAB," "LARC," and sled platforms shown in Figure 6-12. Vessels and other platforms usually merge RTK observations with inertial measurement units in order to reduce out surf heave. Land sections of beach profile surveys are usually controlled using RTK topographic methods, as shown in Figure 6-12 where beach profiles are merged with offshore hydrographic profiles. See also EM 1110-2-1003 (Hydrographic Surveying) for more details on coastal engineering surveys.



Figure 6-12. Differential GPS controlled beach survey platforms--for coastal engineering surveys (ERDC/Coastal & Hydraulics Lab, Jacksonville District, Arc Surveying & Mapping, Inc.)

6-11. Photogrammetric Mapping Control

The use of an airborne GPS (ABGPS) receiver, combined with specialized inertial navigation, LIDAR, and photogrammetric data processing procedures, can significantly reduce the amount of ground control for typical photogrammetric projects. In effect, each camera image or LIDAR scan is accurately positioned and oriented relative to a base reference station on the ground, as shown in Figure 6-13. In the past, the position and orientation of the camera was back-computed from ground control imagery. Traditionally, these mapping projects required a significant amount of manpower and monetary resources for the establishment of the ground control points. Therefore, the use of ABGPS technology significantly lessens the production costs associated with wide-area mapping projects. Tests have shown that ground control coordinates can be developed from an airborne platform using adapted GPS kinematic techniques to centimeter-level precision in all three axes if system related errors are minimized and care is taken in conducting the ABGPS and photogrammetric portions of the procedures. ABGPS has been used extensively in St. Louis and Jacksonville Districts for photo and LIDAR mapping projects. ABGPS is also used to control the Mobile District's airborne LIDAR hydrographic survey system--Figure 6-14. Detailed coverage of ABGPS is given in EM 1110-1-1000 (Photogrammetric Mapping).

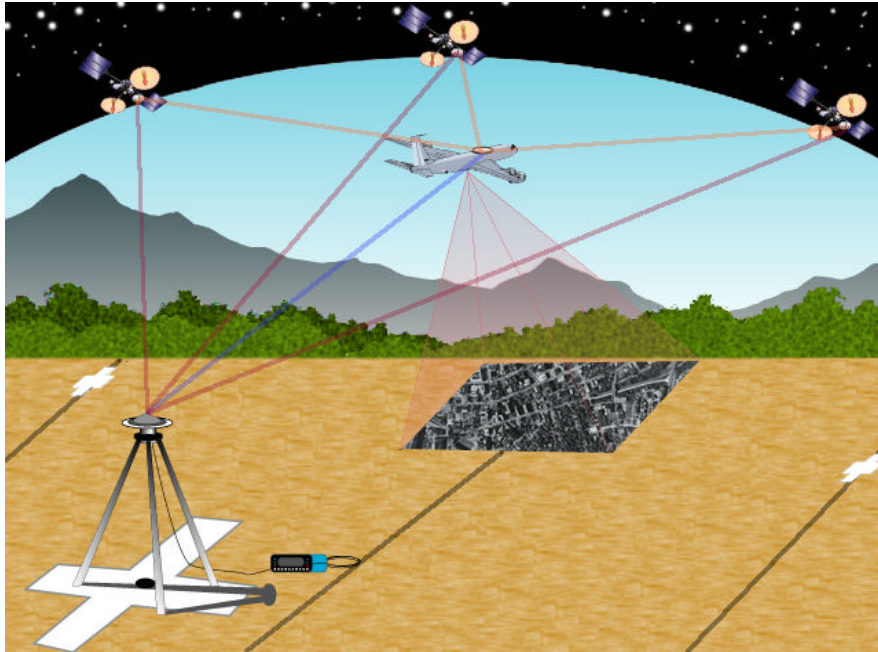

Figure 6-13. Airborne GPS control for photogrammetric mapping projects

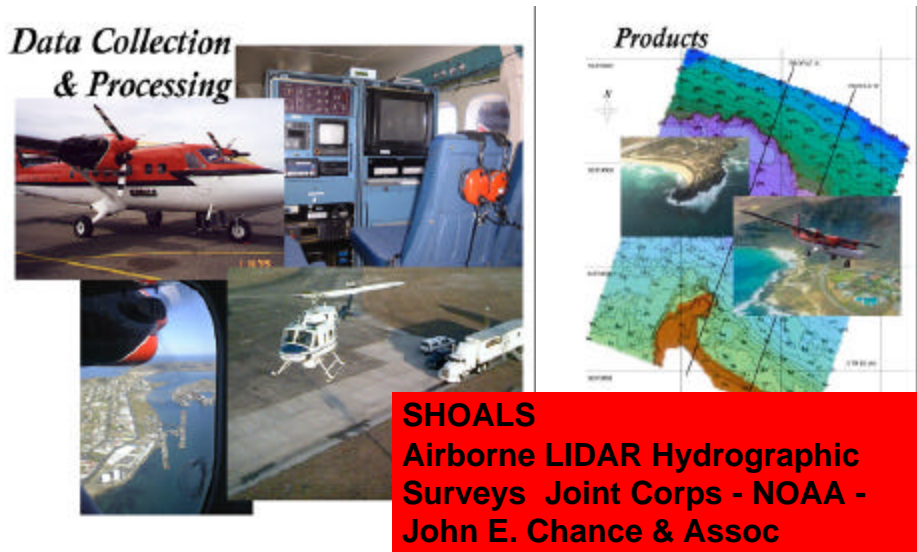

Figure 6-14. USACE GPS-controlled SHOALS hydrographic surveying system (Mobile District)

Chapter 7 GPS Receiver and Equipment Selection

7-1. General

Selection of the right GPS receiver for a particular project is critical to its success. Receiver selection must be based on a sound analysis of the following criteria: applications for which the receiver is to be used (e.g., static or dynamic, code or carrier), accuracy requirements, power consumption requirements, operational environment, signal processing requirements, and cost. GPS receivers range from high-end, high-cost, high-accuracy "geodetic quality" to low-end, low-cost, low-accuracy "resource grade" or "recreational" models. Moderate cost, meter-level accuracy "mapping grade" receivers are also available. Dozens of vendors produce GPS receivers and there are hundreds of models and options available. This chapter presents only a brief overview on GPS survey equipment and selection criteria. References to specific brands, models, prices, and features in this chapter will be rapidly out of date. Current comparative information on GPS receivers and options is readily available in various trade magazines, such as *GPS World*, *POB*, and *Professional Surveyor*. Prior to initiating procurement, USACE commands are also advised to consult ERDC/TEC or other commands for technical guidance on GPS instrumentation options.

7-2. Types of GPS Receivers

There are two general types of GPS receivers: Code Phase and Carrier Phase. Geodetic quality receivers process both code and carrier phases. Geodetic quality receivers (and auxiliary equipment) can cost between \$10,000 and \$25,000. Resource grade (recreational navigation) receivers typically process only the L1 C/A-code and perform absolute positioning. These receivers cost between \$100 and \$1,000. Some moderate cost (\$1,000 to \$5,000) hand-held mapping grade receivers can process either differential code or carrier observations. Within these types there are C/A and P-code receivers, one- or two-channel sequential receivers, multi-channel receivers, codeless receivers, single- and dual-frequency receivers, all-in-view receivers, continuous tracking, code-correlation, cross-correlation, squaring, and a variety of other signal processing techniques. Reference *NAVSTAR GPS User Equipment Introduction* (DoD 1996) or (Kaplan 1996) for further details on receiver signal processing methods.

a. Code Phase receivers. A code receiver is also called a "code correlating" receiver because it requires access to the satellite navigation message of the P- or C/A-code signal to function. This type of receiver relies on the satellite navigation message to provide an almanac for operation and signal processing. Because it uses the satellite navigation message, this type of receiver can produce real-time navigation data. Code receivers have "anywhere fix" capability and consequently, a quicker start-up time at survey commencement. Once locked onto the GPS satellites, an anywhere-fix receiver has the unique capability to begin calculations without being given an approximate location and time.

b. Carrier Phase receivers. A carrier phase receiver utilizes the actual GPS signal itself to calculate a position. There are two general types of carrier phase receivers: (1) single frequency and (2) dual frequency.

(1) Single-Frequency receivers. A single-frequency receiver tracks the L1 frequency signal. A single-frequency receiver can be used effectively to develop relative positions that are accurate over baselines of less than 20 km or where ionospheric effects can generally be ignored.

(2) Dual-Frequency receivers. The dual-frequency receiver tracks both the L1 and L2 frequency signal. A dual-frequency receiver will more effectively resolve baselines longer than 20 km where ionospheric effects have a larger impact on calculations. Dual-frequency receivers eliminate almost all ionospheric effects by combining L1 and L2 observations. All geodetic quality receivers are multi-channel, in which a separate channel is tracking each satellite in view. Most manufacturers of dual-frequency receivers utilize codeless techniques, which allow the use of the L2 during anti-spoofing. Other signal processing techniques include squaring, code-aided squaring, cross-correlation, and z-tracking. Receivers that utilize a squaring technique are only able to obtain 1/2 of the signal wavelength on the L2 during anti-spoofing and have a high 30 dB loss. Receivers that use a cross-correlation technique have a high 27 dB loss but are able to obtain the full wavelength on the L2 during A/S.

7-3. GPS Receiver Selection Considerations

There are numerous factors that need to be considered when purchasing a GPS receiver (or system) for project control or mapping purposes. The following factors and features should be reviewed during the selection process.

a. Project applications. Current USACE applications include land-based, water-based, and airborne positioning, with a wide range of accuracy requirements. Land applications include real-time topographic surveying, geodetic control, resource mapping, navigation, survey control, boundary determination, deformation monitoring, and transportation. Most of these applications require carrier phase, geodetic-quality receivers. Water or marine applications include navigation and positioning of hydrographic surveys, dredges, and drill rigs--typically using meter-level differential code phase positioning techniques. GIS development applications are commonly performed with low cost, resource-grade, hand-held, GPS receivers--using either absolute positioning or code differential techniques. Airborne applications include navigation and positioning of photogrammetric-based mapping and require high-end geodetic GPS receivers along with inertial measurement units (IMU). Some receivers can be used for all types of applications and accuracies--e.g., a GPS receiver may contain capabilities for performing code, carrier, RTK, GLONASS, FAA WAAS, or USCG positioning. Generally, the more applications a receiver must fulfill, the more it will cost. It is important for the receiver's potential project applications be defined in order to select the proper receiver and the necessary options, and to avoid purchase of a \$50,000 GPS system when a \$10,000 system would have sufficed.

b. Accuracy requirements. A firm definition of the point positioning accuracy requirements is essential when deciding on the type of GPS receiver that will be required. Receiver cost typically increases as accuracy is increased. For example, a "geodetic-quality" receiver is usually specified for high-quality Corps project control work, particularly when precise vertical control is being established. Accuracy requirements will further define procedural requirements (static or kinematic), signal reception requirements (whether use of either C/A- or L1/L2 P-codes is appropriate), and the type of measurement required (pseudorange or carrier phase measurements). If only meter-level GIS feature mapping is involved, inexpensive, single-frequency GPS receivers are adequate, if combined with differential corrections.

c. Power requirements. The receiver power requirements are an important factor in the determination of receiver type. Receivers currently run on a variety of internal and external power sources from 110 VAC to 9 to 36 VDC systems. Most systems operate on small rechargeable internal batteries and draw some 1 to 5 watts. A high-end GPS receiver can operate only a few hours on its internal batteries, whereas a low-end, resource grade receiver that draws less power may operate 1 to 2 days on a set of flashlight (AA) batteries. Use of external gel-cell batteries should be also considered as a power source. If continuous structural monitoring or navigation is performed, then the receiver must have an external power option.

d. Operational environment. The operational environment of the survey is also an important factor in the selection of antenna type, antenna and receiver mounting device, receiver dimension and weight, and durability of design. For example, the harsher the environment (high temperature and humidity variability, dirty or muddy work area, etc.), the sturdier the receiver and mount must be. Most receivers are designed to operate over wide temperature ranges and in 100% humidity conditions. Many Corps applications require receivers to be mounted in small workboats exposed to harsh sea conditions and salt water spray. The operational environment will also affect the type of power source to be used.

e. Baseline length. For static control surveys, the typical baseline lengths encountered will determine the type of receiver that is required. Single-frequency receivers are usually adequate for baseline lengths of less than 20 km. Beyond 20 km lengths, dual-frequency receivers are recommended. Real-time kinematic operations require geodetic quality, dual-frequency receivers over all baseline lengths. Precision vertical work may also require dual-frequency receivers.

f. Data logging. Most geodetic quality receivers log data to an external logging device--e.g., a Survey Controller or directly to a laptop computer. Some geodetic quality receivers can also log data internally for later downloading through a communications port. Resource grade hand-held type receivers can collect, process, and display data internally. The amount of storage required is a function of the typical project, data logging rate--1-sec, 5-sec, etc. Most high-end units use memory cards for additional storage requirements. Quality receivers will have 2 to 4 RS-232 ports, with high data transfer rates (e.g., 9,600 to 115,200 baud).

g. Operator display. Most modern receivers and data controllers contain simple icon-based displays for selecting GPS survey modes and data logging options. Costs and options will vary with the size of a LCD display on the receiver or controller. Quality receivers provide audible and visual warnings when data quality is poor.

h. Satellites and channels tracked. Most quality receivers are designed to track 12 or more channels in parallel mode. Many receivers can track 12 or more satellites--some can track "all-in-view."

i. Time to start and reacquire satellites. GPS receivers vary in the time required to cold start (1 to 3 minutes) and warm start (< 1 minute). OTF initialization (and reinitialization) time is also varied. These criteria may be significant for some Corps topographic RTK surveying applications where loss of lock is common due to structures or canopy cover.

j. Size and weight. Size and weight are important if receivers are used for RTK topographic surveys or mapping type work. Most geodetic quality and hand-held receivers weigh from 1 to 5 pounds. RTK remote systems approach 10 pounds when all auxiliary equipment is included.

k. FAA WAAS, USCG, and commercial provider DGPS capability. Receivers with varied code DGPS capabilities are needed in some remote or mountainous areas--especially when one of the DGPS provider signals is poor or unreceivable. Some receivers are designed to acquire commercial, FAA WAAS, and USCG DGPS pseudorange corrections.

l. GLONASS capability. The ability to acquire and process Russian GLONASS satellites (and other future GNSS systems) would be advantageous in mountainous or urban areas where NAVSTAR GPS satellites are partially blocked. The acquisition of additional satellites also provides higher geometric accuracy.

m. Antenna type. A wide variety of antennas are available from GPS receiver manufacturers. In addition, optional antenna types can be ordered with the same receiver. Some antennas are built into the receiver and others are external. Multipath minimization will require more expensive antennas for static control survey applications. These include antennas configured with ground planes and choke rings. For high accuracy work, antenna reference points should be modeled, as illustrated in Figure 7-1.

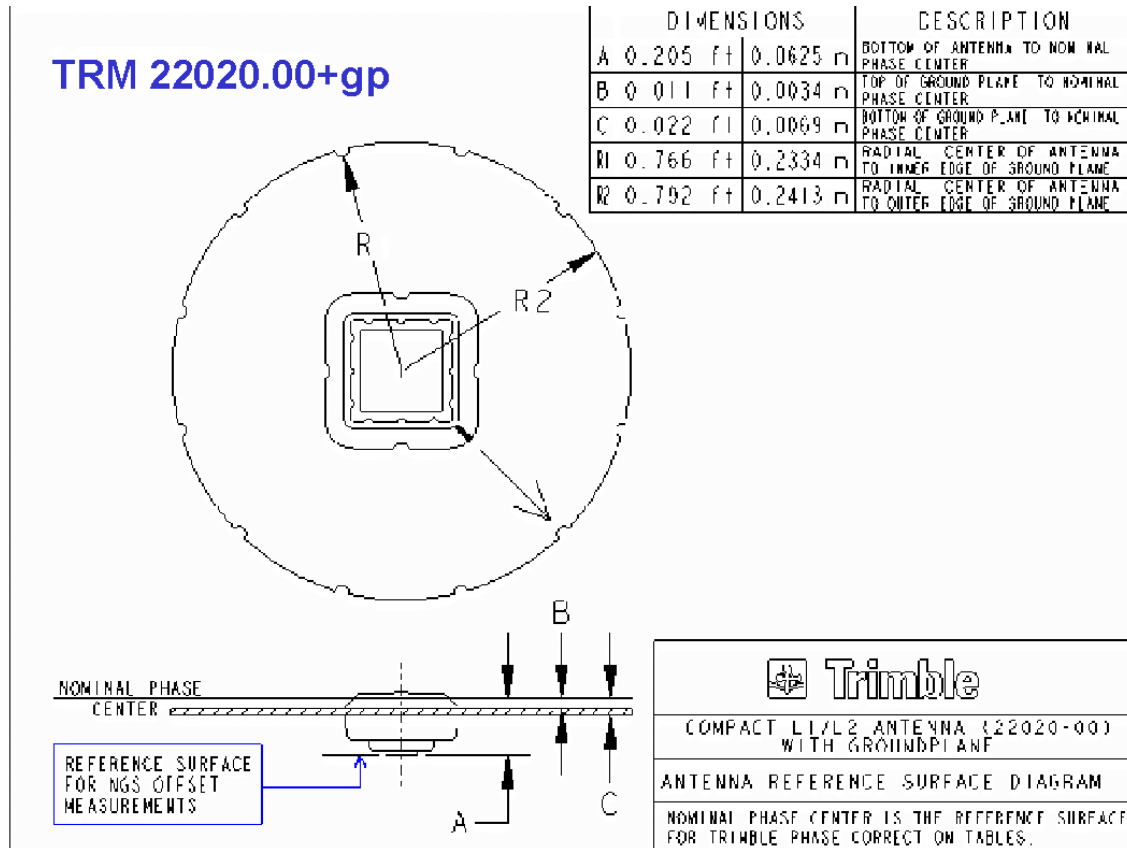

Figure 7-1. Typical antenna reference and offset diagram

n. Processing requirements. Operational procedures required before, during, and after an observation session are manufacturer dependent and should be thoughtfully considered (and tested) before purchase of a receiver. Often, a receiver may be easy to operate in the field, requiring very little user interface, but a tremendous amount of time and effort may be required after the survey to download the data from the receiver and process it (i.e. post-processing software may be complicated, crude, or underdeveloped). Also, whether a post-processed or real-time solution is desired represents a variable that is critical in determining the type of receiver to use.

o. Cost. Cost is a major factor in determining the type of receiver the user can purchase. Receiver hardware and software costs are a function of development costs, competition among manufacturers, and product demand. Historically, costs for the acquisition of GPS equipment have steadily fallen to the current range of prices seen today. Cost estimates must include full GPS systems along with auxiliary equipment, software, training, etc. A sample schedule for many of these cost items is shown at the end of this chapter.

p. Data exchange formats. In order to transfer data, a common exchange format is required. GPS vendors usually have their own proprietary data formats. However, most GPS receiver data can be put into a common text format, such as the Receiver Independent Exchange (RINEX) format, which is used for post-processed data. RINEX is more fully described in a later section. Real-time data exchange, such as that used on RTK surveys, is typically handled using the RTCM SC-104 format standard. Vendors often allow for optional outputs, such as ASCII, DXF, ArcInfo, DGN, NMEA 0183, etc.

7-4. Military Grade GPS Receivers

Military Grade GPS receiver systems provide high accuracy positioning for real-time and post-processed military survey applications. These applications include precise positioning and orientation of artillery, ground-based surveys, and surface navigation. Military receivers use the Precise Positioning Service (PPS) providing advanced P(Y) Code positioning technologies accurate to approximately 4 –16 meters (SEP). Using the secure (Y-code) differential GPS (SDGPS) can increase the accuracies to the sub-meter level. PPS receivers require a crypto key to decode the encrypted P-Code and typically have to be re-keyed each year.

a. PLGR. The Precise Lightweight GPS Receiver (PLGR), manufactured by Rockwell Collins, is a hand-held receiver designed to operate as a stand-alone unit, providing position, navigation information, velocity and time. Figure 7-2 depicts the PLGR+96 on the left and PLGR II on the right.



Figure 7-2. PLGR+96 (left) and PLGR II (right)

b. MSGR. Trimble Navigation offers the 4000 Military Survey GPS Receiver (MSGR) that is a dual-frequency geodetic-quality PPS receiver, providing all the capabilities of high-quality C/A-Code receivers, including the ability to perform RTK and differential (DGPS) surveys.



Figure 7-3. Trimble Navigation 4000 MSGR

7-5. GPS Receiver Manufacturers

Up-to-date listings of manufacturers are contained in various surveying trade publications and are listed on the ERDC/TEC web site. Contact should be made directly with representatives of each vendor to obtain current specifications, price, availability, material, or other related data on their products. Prior to purchase, it is recommended that receivers be tested to ensure they meet performance requirements and will efficiently transfer positional and feature data to post-processing devices and/or CADD/GIS platforms. Most GPS equipment required for USACE applications is listed on the GSA Supply Schedule and can be obtained directly off that schedule without competition--see FAR 8.4, Section 8.404.

7-6. Other Auxiliary Equipment

A significant amount of auxiliary equipment may need to be acquired when making a GPS receiver selection. Some of this equipment is discussed below.



Figure 7-4. Miscellaneous auxiliary equipment needed for a GPS survey

a. *Data link equipment for real-time positioning.* The type of data link needed for real-time positioning (i.e. code or carrier RTK) should be capable of transmitting digital data. The specific type of data link will depend on the user's work area and environment. Most manufacturers of GPS equipment can supply or suggest a data link that can be used for real-time positioning. Depending on the type and wattage of the data link, a frequency authorization may be needed in order to transmit digital data over radio frequencies (RF). Frequency authorization requires coordination with the frequency coordinator in the District and HQUSACE, and is a difficult and involved process. Some radio and GPS manufacturers produce low-wattage spread spectrum transmitters that do not require frequency authorization. These low-wattage broadcasts are normally only useful for topographic RTK surveys not exceeding 1 km from the reference station. The data link may be built into the receiver or in an external unit. Some Corps districts have obtained approval to broadcast RTK correctors on approved frequencies in the VHF range--162-174 MHz. Local VHF broadcasts have been used to transmit RTK corrections out to 10-15 miles offshore--for controlling hydrographic surveys on dredging projects. Use of wireless technology (e.g., local and satellite cell phones) may prove to be more effective and efficient data links than VHF links, especially if frequency authorizations cannot be obtained. Many commercial vendors are now using wireless satellite links to transmit DGPS correctors to users.

GPS antenna
and separate
Differential
Corrections
antenna

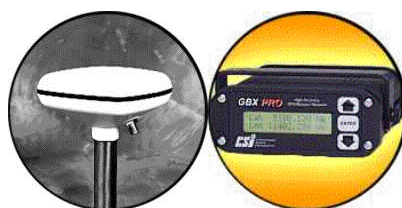

Combined GPS/USCG
beacon antenna



Combined
GPS/USCG/
Satellite Diff
Corrections
antenna

Combined
GPS/Satellite
Diff Corrections



Figure 7-5. Common data links for code and RTK GPS receivers

b. USCG radiobeacon receivers. The USCG provides a real-time pseudorange corrections broadcast over medium frequency (270-320 kHz marine band) from a radiobeacon transmitter tower. These towers exist in most coastal areas, the Mississippi River Basin, and the Great Lakes regions. The range from each tower is approximately 120 to 300 km. These corrections can be received by using a radiobeacon receiver and antenna tuned to the nearest tower site. USCG beacon receivers are usually contained in one unit that contains the antennas and GPS processing/display features--see Figure 7-5. Similar configurations are made for wide area, commercial-provider, differential GPS services.

c. Computer equipment. Most manufacturers of GPS receivers include computer specifications needed to run their downloading and post-processing software. Most high-end desktop and notebook/laptop computers are capable of processing GPS data. Portable laptop computers are essential for performing near real-time data post-processing--especially in remote locations. An internal CD-RW drive is also recommended for archiving the large amounts of data that will be collected.

d. Antenna types. There are three basic types of GPS antennas. These are (1) ground plane antennas, (2) no ground plane, and (3) choke ring antennas. Both the ground plane and the choke rings are designed to reduce the effect of multipath on the antenna.

e. Associated survey equipment. There are several accessories needed to support the GPS receiver and antenna. These include backpacks, tripods, tribrachs, and tribrach adapters, to name a few. Calibrated fixed height (usually 2 meter) range poles can be used to eliminate the need to measure antenna heights. Most of the other equipment needed is similar to what is used on a conventional survey.

7-7. Resource Grade GIS Mapping Receivers

Dozens of hand-held resource grade GPS receivers are produced that can display and log geospatial positional data in real-time. USACE applications for these inexpensive receivers are varied. They will

provide sufficient accuracy for vessel, vehicle, and personal real-time navigation. They may also be used for building GIS databases where 10-30 meter horizontal accuracy is adequate for a feature, e.g., land use, point features, flood inundation limits, emergency operations, dredge disposal monitoring, etc. The following descriptions for some representative receivers were obtained from a 2000 US Forest Service report entitled *Performance Testing of the Garmin eTrex, Garmin GPSIII Plus, Magellan GPS 2000XL, and Magellan Blazer Recreation Type Global Positioning System Receivers*, and from other similar USFS test reports. In these reports, testing indicated that all the receivers were capable of meeting USGS quadrangle map accuracy standards (14.8 meters at 95%) in open areas. The following list is not representative of all the resource grade receivers on the market, nor does it include other models by the same vendor--those listed are only representative of the receivers tested by the USFS. For updated information on testing of resource grade receivers, consult the USFS GPS web site by linking through the ERDC/TEC web site.

- **Garmin eTrex:** This is a very small, lightweight, field-ruggedized with some armoring, and waterproof unit that stores 500 waypoints. Battery life is about 22 hours for 2 AA batteries. This receiver has PC communications with an optional data cable allowing uploading of waypoints. Weight is 6 ounces. Display is 64 x 128 characters. The cost of this unit is approximately \$120.
- **Garmin GPS III Plus :** This is a small, lightweight, and waterproof unit that stores 500 waypoints. It has a 4-color grayscale background map display and can store up to 1.44 mg of Garmin format map data. No other map formats are supported. These maps are on an optional CD at 100,000 scale, the cost is an additional \$120. A data upload cable is supplied for uploading maps and waypoints. Display is 100 x 160 characters. Weight is 9 ounces. The cost of this unit is approximately \$380.
- **Magellan GPS 2000XL:** This is a slightly larger unit which is waterproof, field ruggedized with wraparound rubber armoring, and scratch-proof display. The GPS 2000 XL receiver stores 200 waypoints. This unit offers NMEA data output for PC communication. The battery life is about 24 hours for 4 AA batteries. Weight is 10 ounces. Cost is approximately \$150.
- **Magellan Blazer 12:** This is a small, lightweight, and waterproof unit that stores 100 waypoints. Battery life on this receiver is about 20 hours for 2 AA batteries. No NMEA data output. The Blazer 12 shares the same receiver and quadrifilar antenna with the other Magellan 300 series receivers; however the user interface menus, number of waypoints, the availability of NMEA ports, and many other features, vary. The accuracy of other 300 series receivers should be similar to the Blazer. Weight is 6.8 ounces. The cost of the Blazer12 is approximately \$110.
- **Trimble GeoExplorer:** Trimble Navigation GeoExplorer 3c is a 12-channel Global Positioning System (GPS) receiver. The manufacturer's list price for the GeoExplorer 3c (without map background) is \$3,780; the GSA price is \$3,495. The manufacturer's list price for the GeoExplorer 3 (with map background) is \$4,495; the GSA price is \$4,090. The external antenna is an optional item for the GeoExplorer 3c. The manufacturer's list price for the antenna is an additional \$195 and the GSA price is currently \$177.
- **Trimble Pathfinder Pro XR.** The Trimble Navigation Pathfinder Pro XR is a 12-channel Global Positioning System (GPS) receiver. The Pathfinder Pro XR version 3.24 has an integrated GPS and DGPS radio beacon antenna. The TSC1 data collector can be used with the Asset Surveyor version 4.3 Software. The manufacturer's list price is \$10,995; the GSA price for the Pathfinder Pro XR is \$10,005.

7-8. Common Data Exchange Formats

a. *RINEX*. The Receiver INdependent EXchange (RINEX) format is an ASCII type format that allows a user to combine data from different manufacturer's GPS receivers. Most GPS receiver manufactures supply programs to convert raw GPS data into a RINEX format. However, one must be careful since there are different types of RINEX conversions. Currently, the NGS distributes software that converts several receiver's raw GPS data to RINEX. NGS will distribute this software free of charge to any government agency. Portions of typical RINEX data files are shown below. For each satellite tracked, the code distance and L1/L2 phases and Doppler count values are listed.

SAMPLE RINEX DATA FILE (San Juan, PR Jacksonville District, Ashtech Z-12 Receiver)

```

2IU          OBSERVATION DATA      G (GPS)          RINEX VERSION / TYPE
ASHTORIN          28 - JUN - 02 10:04 PGM / RUN BY / DATE
0003          COMMENT
          MARKER NAME
          MARKER NUMBER
          OBSERVER / AGENCY
          ASHTECH Z-XII P3      5J00      1C63      REC # / TYPE / VERS
          ANT # / TYPE
          APPROX POSITION XYZ
          ANTENNA: DELTA H/E/N
          WAVELENGTH FACT L1/2
          # / TYPES OF OBSERV
          INTERVAL
          LEAP SECONDS
          TIME OF FIRST OBS
          TIME OF LAST OBS
          END OF HEADER
02 6 25 14 53 30.0000000 0 9G30G29G26G04G05G24G23G07G10      0.000824454
-53922.08817      -40565.76855      24455490.816      24455491.4555      24455501.0845      244.850      190.792
-661208.301 9      -483872.18747      22216675.275      22216675.4604      22216683.1604      3159.150      2461.675
-820204.442 9      -618074.31947      22985123.892      22985124.3594      22985133.6494      3935.982      3066.999
128043.142 9      93257.10846      23165282.101      23165282.0234      23165290.6074      -623.838      -486.108
153403.432 9      116423.82546      23937298.328      23937298.3884      23937308.7384      -768.304      -598.678
-166500.297 9      -125905.16547      22117555.722      22117555.8774      22117562.4454      793.354      618.198
-264887.037 9      -197951.30346      22994119.533      22994119.7104      22994129.0024      1453.557      1132.642
631877.719 9      456127.79446      23737042.567      23737042.5564      23737055.5554      -3149.638      -2454.263
60447.345 9      43299.05948      21136470.357      21136469.9054      21136476.3494      -330.782      -257.752

02 6 25 16 24 15.0000000 0 8G29G26G04G24G23G08G10G06      0.000647879
-9746894.726 9      -7563623.36248      20487724.730      20487724.5844      20487730.9614      53.897      41.998
-15098913.388 9      -11744332.87548      20267971.265      20267971.3024      20267977.8754      975.770      760.340
7481368.270 9      5823092.22845      24564595.467      24564595.5644      24564609.5154      -2091.033      -1629.376
-1518814.840 9      -1179665.38447      21860226.133      21860225.8804      21860234.9044      -476.719      -371.469
-2944679.055 9      -2286098.15047      22484172.149      22484171.6184      22484179.9644      -68.190      -53.135
-4418906.717 7      -3437358.05045      24462270.403      24462269.6634      24462286.6644      -294.665      -229.609
5736700.177 9      4466347.01547      22216631.531      22216630.7024      22216638.0044      -1310.212      -1020.944
-10589645.118 9      -8230960.83247      22710603.800      22710603.6414      22710611.8954      1959.993      1527.267

```

SAMPLE RINEX DATA FILE (New Orleans District, Trimble 4000SSE receiver)

```

2.10 OBSERVATION DATA G (GPS) RINEX VERSION / TYPE
DAT2RINW 3.10 001 Huber 25MAR02 6:52:52 PGM / RUN BY / DATE
Huber USACE OBSERVER / AGENCY
4936 TRIMBLE 4000SSE Nav 7.29 Sig 3.07 REC # / TYPE / VERS
00000000 TR GEOD L1/L2 GP ANT # / TYPE
-----
Offset from BOTTOM OF ANTENNA to PHASE CENTER is 62.5 mm
-----
4936 MARKER NAME
4936 MARKER NUMBER
-13020.5085 -5531624.9704 3164468.2517 APPROX POSITION XYZ
1.5468 0.0000 0.0000 ANTENNA: DELTA H/E/N
*** Above antenna height is from mark to BOTTOM OF ANTENNA.
-----
Note: The above offsets are CORRECTED.
Raw Offsets: H= 1.6093 E= 0.0000 N= 0.0000
-----
1 1 0 WAVELENGTH FACT L1/2
4 L1 C1 L2 P2 # / TYPES OF OBSERV
1.000 INTERVAL
2002 3 21 14 27 2.0000000 TIME OF FIRST OBS
2002 3 21 16 31 49.0000000 TIME OF LAST OBS
0 RCV CLOCK OFFS APPL
5 # OF SATELLITES
4 4578 4579 4521 4521 PRN / # OF OBS
7 7488 7488 7488 7488 PRN / # OF OBS
8 7488 7488 7488 7488 PRN / # OF OBS
11 7248 7248 7185 7185 PRN / # OF OBS
27 5719 5719 5719 5719 PRN / # OF OBS
END OF HEADER
02 3 21 14 27 2.0000000 0 4 7 8 11 27
-116189.39216 22284950.00806 -87567.87956 22284956.61746
-24189.13717 20059524.33607 -6825.36657 20059529.75047
388.50517 21728548.97707 302.52057 21728554.56647
96650.22817 20791241.16407 72757.93557 20791247.08247
02 3 21 14 27 3.0000000 0 4 7 8 11 27

```

b. *Real-time data transmission formats.* There are two common types of data formats used most often during real-time surveying. They are (1) RTCM SC-104 and (2) NMEA.

(1) Transmission of data between GPS receivers. The Radio Technical Commission for Maritime Services (RTCM) is the governing body for transmissions used for maritime services. The RTCM Special Committee 104 (SC-104) has defined the format for transmission of GPS corrections. The RTCM SC-104 standard was specifically developed to address meter-level positioning requirements. The current transmission standard for meter-level DGPS is the RTCM SC-104. This standard enables communications between equipment from various manufacturers. It should be noted that not all manufacturers fully support the RTCM SC-104 format and careful consideration should be made to choose one that does. RTCM SC-104 can also be used as the transfer format for centimeter-level DGPS, and will support transmission of raw carrier phase data, raw pseudorange data, and corrections for both. Some GPS receiver manufacturers also have their own proprietary transfer formats--e.g., Trimble's Compact Measurement Record (CMR).

(2) Transmission of data between a GPS receiver and a device. The National Maritime Electronics Association (NMEA) *Standard for Interfacing Marine Electronic Devices* covers the format for GPS output records. The standard for corrected GPS output records at the remote receiver is found under NMEA 0183, Version 2.xx. NMEA 0183 output records can be used as input to whatever system the GPS remote receiver is interfaced. For example, GPS receivers with an NMEA 0183 output can be used to provide the positional input for a hydrographic survey system or an Electronic Chart Display and Information System (ECDIS). These are evolving standards and newer versions are being developed for different data types. The NMEA 0183 Version 2.00 (1992) "GGA" standard for GPS "fix data" is outlined below. This version has been subsequently updated--users need to ensure NEMA version compatibility between devices. Other NEMA 0183 standards include: GST (Position error statistics), GSV (Number of satellites in view, PRN, etc.), PTNL (Local coordinate position output), and ZDA (UTC day-month-year).

GGA--Global Positioning System Fix Data (Time, Position, and Fix Related Data for a GPS Receiver)
[Version 2.00]

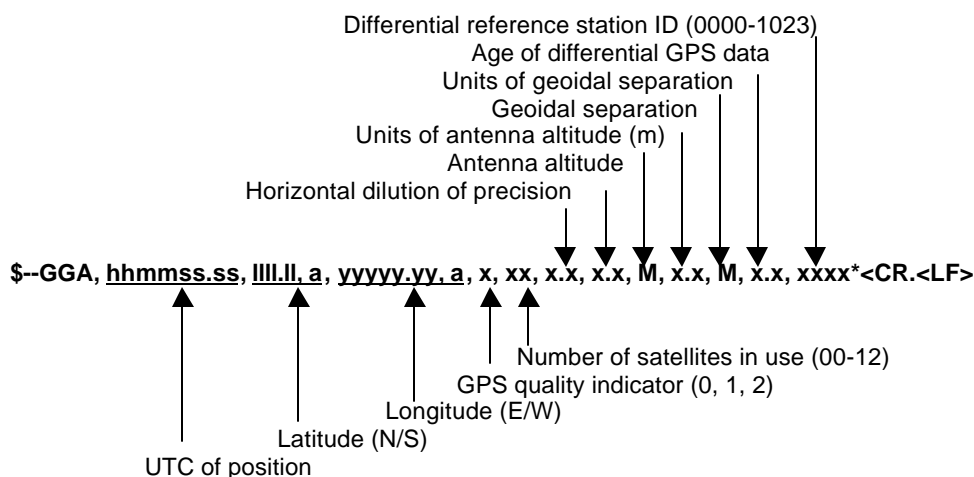

7-9. GPS Training and Operation Manuals

Training should be included in the purchase of any GPS receiver system, especially if the equipment is new to a District. In addition to receiver operation, training should include baseline reduction, and network adjustment. The Corps PROSPECT program provides a one-week training course on code and carrier GPS surveying. This course covers all chapters contained in this engineer manual. Major GPS vendors offer training in all facets of GPS surveying unique to their equipment or software. In addition, continued technical support should be included to cover all software and firmware upgrades.

7-10. Guide Specifications for Procuring Geodetic Quality GPS Receivers

The following guide specification is intended for procuring geodetic-quality GPS receivers and auxiliary equipment. These specifications would have application where "commercial-off-the-shelf" receivers available on GSA Schedules would not meet a particular application, and detailed specifications are needed. These specifications are intended to include GPS receivers, supplemental GPS equipment (antennas, tripods, power, etc.), baseline reduction software, adjustment software, real-time data links, and personnel training. These specifications may be modified for meter-level code phase receivers if required; however, code only receivers rarely require such detailed specifications. These guide specifications were originally developed in the late 1980s. They were first published as a USACE Guide Specification in 1991 and later incorporated into the 1996 edition of this manual. They have been modified to reflect 2002 technology. Guidance comments are shown in blue text and outlined by asterisks. Optional and/or selectable specifications are noted by asterisks and brackets.

NOTE: The sample below represents a typical schedule for procurement of GPS instrumentation and related equipment. This schedule must be tailored based on the specific technical requirements outlined in Section C of the contract.

Supplies/Services and Prices

Item No.	Description	Quantity	U/M	U/P	Amt
0001	Geodetic quality GPS survey receiver system, related equipment, software, data link, and other components, in accordance with the technical specifications found in Section C.	*[____]	EA	____	____
0002	* [GPS baseline reduction software]	____	____	____	____
0003	* [Network adjustment software]	____	____	____	____
0004	* [Data link for real-time applications]	____	____	____	____
0005	* [GPS receiver system, data reduction, processing and adjustment software training]	____	____	____	____
0006	* [other items]				

NOTE: Add other items to the schedule as necessary. These may include tripods, range poles, tribrachs, spare batteries, data storage devices, laptop computers, communication/modem devices, software/hardware for navigation (e.g., survey vessel positioning and guidance control). Hardware/software interface requirements to existing survey systems (e.g., hydrographic systems) may also be separately scheduled.

Section C

Description / Specifications

C.1. General DGPS Description.

The geodetic-quality differential Global Positioning System (DGPS) to be procured under this solicitation is intended for use in *[static and/or kinematic] positioning applications using the GPS carrier phase as the principle observable. The system will yield 3-dimensional vectors between a reference and "rover" station to an accuracy of *[10 mm + 2 ppm or better on baselines of 1 to 100 km when operating in a static mode] [and] *[3 cm or better on baselines up to 25 km when operating in a kinematic mode]. *[The system is intended to operate in real time with the incorporation of a communications link, as specified further in Section C of this solicitation.] *[The system will have the capability to resolve the initial integer cycle ambiguity in a robust manner, automatically, while the rover is constantly in motion, known as on-the-fly (OTF), with no more than 60 sec of data, on baselines up to 25 km in length.] *[The OTF ambiguity resolution software will operate in *[real time] *[and/or] *[post-processing applications].

C.2. Receiver Requirements.

Unless otherwise specified, the performance requirements given below shall be met by the GPS receivers in conjunction with the antenna assembly and antenna cable.

C.2.1. GPS Signal Levels. GPS receivers delivered shall acquire and track GPS signals and otherwise perform as specified herein.

C.2.2. Cryptographic Keys. *[Unless otherwise specified,] GPS receivers shall perform as specified herein without requiring cryptographic keys, whether or not GPS selective availability (S/A) and/or anti-spoofing (A/S) are activated.

NOTE: Two versions of C.2.3. are given. L1 only receivers are adequate for static geodetic survey operations. Robust kinematic operations and OTF ambiguity resolution requires more capable hardware observing the full wavelength L1 and full wavelength L2 carrier phase. Choose one of the two clauses.

*[C.2.3. GPS Observables. The GPS receivers delivered shall provide, at a minimum, the following time-tagged observables: full L1 C/A-code, L1 P-code, continuous full wavelength L1 carrier phase, L2 P-code, and continuous full wavelength L2 carrier phase.]

*[C.2.3. GPS Observables. The GPS receivers delivered shall provide, at a minimum, the following time-tagged observables: full L1 C/A-code and continuous full wavelength L1 carrier phase.]

(1) Measurement Time Tags. Signal measurements (observables) shall be time tagged with the time of receipt of the signal referenced to the receiver clock. Time tags shall have a resolution of 1 microsec or better. Time tags shall be within 1 microsec with respect to GPS time.

(2) Carrier Phase Accuracy. The receiver shall have L1 *{the following is required for OTF operation}* *[and L2 full wavelength] carrier-phase measurement accuracies of 0.75 cm (RMS) or better, exclusive of the receiver clock offset.

NOTE: The following C.2.3. (3) is for RTK/OTF operation only.

*[(3) Code Accuracy. The receiver shall have an L1 C/A-code phase measurement accuracy of 30 cm (RMS) or better, exclusive of receiver clock time and frequency offsets.]

C.2.4. Receiver Output. The GPS receiver shall be able to output the GPS observables as described in C.2.3. with a latency of less than 1 sec *[and, simultaneously, a differential code position and the timing information stated in 2.6]. The GPS receiver shall be able to output the information from the full GPS navigation message. This shall include ephemeris data, almanac data, ionospheric parameters, and coordinated universal time (UTC) parameters. The UTC and ephemeris data shall be available by request or if a change has occurred in those parameters.

C.2.5. Receiver Data Rate. The GPS observable data described above shall be available at a minimum of a 1 Hz rate.

C.2.6. 1 Pulse Per Second (PPS) Output. GPS receivers delivered shall have a 1 PPS time strobe and its associated time tag. The 1 PPS pulse and time tag shall be accessible through a port (or ports) on the GPS receiver so that external system components can be time synchronized to UTC time.

C.2.7. Internal Receiver Testing. The receiver shall perform a self-test and checks to detect electronic malfunctions and/or faulty data collection, including cycle slips. The receiver shall provide immediate *[audio]*[visual] notification of failures. The receiver shall perform any needed calibrations automatically.

C.2.8. Reinitialization. The receiver shall be capable of reinitializing itself and resume normal operation after a power interruption without operator assistance. The data collected by the GPS receiver shall not be lost due to power interruption but stored in the receiver or other archiving media.

C.2.9. Multiple Satellite Tracking. The receiver must be capable of tracking and observing all signals previously stated on a minimum of *[_____] [all satellites in view] satellites simultaneously, each on an independent channel.

C.2.10. Operating Conditions. The GPS receivers delivered shall meet the following criteria:

- (1) Successfully acquire and track unobstructed GPS satellites, visible 5 deg and higher above the horizon, in all weather conditions.
- (2) Operate at humidity ranges of 0 to 100 percent.
- (3) Operate within the temperature range of -20 o C to +50 o C.
- *[(4) Be waterproof and able to operate in an ocean environment aboard open survey launches.]
- *[(5) Operate in heavy rain, 50.8 mm/day (2 in./day).]
- *[(6) Operate in fog.]
- *[(7) Operate in and resist corrosion in salty air conditions.]

C.2.11. Receiver Power Requirements. The GPS receivers delivered shall meet the following criteria:

- (1) Be self-protecting from power surges, spikes, and reverse polarity.
- (2) Allow the operator to switch power sources (AC, DC, or battery) while maintaining receiver operation and without loss of stored data.
- (3) Provide a *[visual] *[audible] warning for low power.
- (4) Be capable of operating using *[a battery pack] *[and] *[or] *[AC power] *[and] *[or] *[12-VDC] *[24-VDC] *[external DC power].
- *[(5) The battery pack shall meet the following criteria:]
 - *(a) Contain rechargeable battery/batteries that can operate the receiver for at least *[_____] hr on a single (re)charge.]
 - *(b) Be *[either] *[internal] *[or] *[external] to the receiver.]
 - *(c) Include all cables, hardware, etc. necessary to connect/install the battery pack. The batteries shall be water and dust tight and be protected from damage and inadvertent shorting of the terminals.]
- *[(6) For operation using *[AC] *[and] *[external DC] *[power.]
 - *(a) When operating under *[AC] *[or] *[DC] power, the unit shall be capable of simultaneously charging the battery pack. The battery pack shall power the receiver if the normal power supply is interrupted.]
 - *(b) The AC power supply *[shall be internal] *[may be internal or external] to the receiver.]
 - *(c) The power supply/battery charger shall provide all voltages necessary to operate the receiver and (re)charge the battery pack.]
 - *(d) The power supply/battery charger shall be designed to automatically protect the battery pack from overcharging.]
 - *(e) All cables and connectors needed to connect the power supply/battery charger to the power line *[and receiver] shall be included.]
 - *(f) The AC power supply/battery charger shall operate from *[115-V] *[and 230-V] AC (10 percent) *[50/] 60 Hz, single phase power.]
 - *(g) The unit shall operate from external *[12-VDC] *[24-VDC] *[9 to 32-VDC] power.]

NOTE: Not all manufacturers provide a battery that is internal to the receiver. Moving the battery pack external to the receiver does not affect the functioning; it is a matter of design. For example, doing this could substantially decrease the size of the unit. Different manufacturers have different setups for the batteries. The District is encouraged to know what will work best for them based upon District requirements and determine the necessary battery life. Note also if redundant battery packs should be procured.

EM 1110-1-1003
1 Jul 03

C.2.12. Manuals. At least *[one set] [two sets] of complete operation and maintenance manuals shall be included with each receiver and shall cover all auxiliary components furnished with each receiver. *[Updates shall be furnished as they become available.]

*[C.2.13. Field Planning. The receiver shall have internal software that, as a minimum, is capable of computing the availability and positions of satellites for any given time and the current position of the GPS receiver *[and terrestrial position] using data gathered by the GPS receiver.]

*[C.2.14. Dimensions. The dimensions of the receiver shall not exceed *[] length by *[] width by *[] height, all such that one person can easily transport the unit.]

*[C.2.15. Weight. The receiver shall be transportable by one person. [One complete field station consisting of receiver, battery pack, antenna, and antenna cable shall not exceed * [] kg * () lbs.]

*[C.2.16. Data Collector. The *[receiver] [external survey data collector] shall be capable of recording and controlling data on an *[internal]*[external] storage device. This device shall be capable of storing a minimum of *[] megabytes (mb) of data.]

*[C.2.17. Additional Options for Meter-level DGPS Operations.]

NOTE: The following section is optional. It is possible for "geodetic type" GPS receivers as described previously to perform differential code (meter-level) positioning using standard broadcast messages from systems such as the US Coast Guard radio beacon network, FAA WAAS networks, or commercial provider networks. If this type of positioning is required, then the following options should be included in the solicitation.

*[(1) Format. The reference station receiver shall output DGPS pseudorange correction data in the RTCM SC-104 format, Version x.x and US Coast Guard Broadcast Standard] *[FAA WAAS] [commercial provider network].

*[(2) Format. The remote station receiver shall accept and apply correction data in RTCM SC-104 format, version 2.1.]

*[(3) Accuracy. Real time positioning accuracy relative to the reference station shall be *[2] [] m 95% within a range of at least 100 miles from the reference station.]

*[(4) Waypoints. The receivers shall have the ability to accept up to *[] waypoints that can be selected by the helmsman.]

*[(5) Position Rate. The receiver shall be capable of providing output position fixes at rates within the range of [] Hz to [] Hz.]

*[(6) Velocity. The receiver shall be capable of determining *[velocity and] position while moving at speeds of up to [5.14] * [] meters per sec (*[10] *[] knots).]

*[C.2.18. Additional Options for Geodetic Grade Static Survey Operations.]

*[(1) Accuracy Specification. The GPS reference receiver shall be capable, when used in conjunction with a remote GPS receiver, of 10 mm + 2 ppm accuracy or better on baselines of 1 to 100 km in length when used in the static differential mode. The receivers shall have an accuracy of 5 mm or better on baselines less than 1 km.]

C.2.19. GPS Antenna Assembly.

(1) Antenna Mount. The GPS antenna shall be capable of being mounted on a standard surveyor's tripod *[and or range pole] with a 5/8-in. by 11-in. threaded stud *[or to a standard wild type tribrach].

(2) Antenna Phase Center. The center instability of the 3-dimensional phase center of the GPS antenna shall be no greater than 3 mm.

(3) Receiver/Antenna Separation. The system shall allow the antenna to be located at least *[30] *[] m from the receiver so that it can be operated remotely from the receiver with no system degradation.

(4) Antenna Cables. *[One] *[] antenna cable(s) shall be furnished with each receiver. *[[One] *[each] of these cables should be at least *[] m,] * [and the other cable should be at least *[] m.] All appropriate connectors should already be attached to the cable ends. *[These cables shall be capable of being cascaded for a total length of *[] m of cable for setup flexibility.]

(5) GPS Survey Antenna. Survey antennas shall receive GPS signals at the L1 *[and L2] frequency *[frequencies] and provide these signals to the GPS receiver. The antenna shall have an omnidirectional horizontal pattern and shall incorporate *[choke ring] features that minimize multipath error.

- *[(6) Antenna Assembly. The antenna assembly shall include the following items:
 - *[(a) A method to minimize ice and snow buildup.]
 - *[(b) A method to reduce bird nesting capability.]
 - *[(c) The ability to withstand strong winds up to * [] meters per sec (* [] knots).]
 - *[(d) A method to orient (to north) after mounting.]
 - *[(e) A mechanical mark for height measurement with known offset from phase center.]
 - *[(f) Operation within the temperature range of -40 o C to +65 o C.]
 - *[(g) Dimensions. The dimensions of the antenna shall not exceed *[45 cm] in length by *[45 cm] in width by *[15 cm] in height, all so that one person can easily transport the unit.]
 - *[(h) A method to reduce the effects of multipath.]
 - *[(i) A method to amplify the signal for cable lengths in excess of 15 m.]
- *[(7) Each antenna shall be 100 percent sealed/watertight. *[One] * [] GPS antenna shall be provided with each GPS receiver unit.]
- *[(8) Antenna Pole. An antenna pole shall be provided for use during survey operations. It shall be *[a fixed height pole of 2 m] *[extendible from a length of 1 m (+/- 0.2 m) to 2 m (with a variance of 0.5 m)] and shall allow rapid attachment and detachment of the GPS survey antenna. The pole shall include a built-in leveling device and legs that are *[collapsible and attached] *[detachable].]
- *[(9) Tribrach. A standard tribrach (with adapters) shall be provided with each antenna. The tribrach shall allow the antenna to be mounted atop the tripod. The tribrach shall be able to be mounted on top of a standard surveyor's tripod with a 5/8-in. threaded stud and shall include adapters to allow mounting of standard target sets.]
- *[(10) Vehicular Antenna Mount. A survey antenna mount shall be provided that can easily be attached or detached from the vehicle. This mount shall be designed so that it remains firmly in place at speeds of up to 88.5 km/h (55 mph) on a level roadway. The mount shall be designed so that its use does not require vehicle modification.]

C.2.20. Input and Output (I/O) Ports.

- (1) Standards. All I/O ports will be compatible with the RS-232 standard.
- (2) I/O Ports. *[I/O ports shall be compatible with any processor, data terminal, or storage devices used in the positioning system.] *[The vendor shall provide complete documentation of the I/O ports including connector, signal descriptors, connector pin outs, communications protocols, command and message descriptions, need to set up the receiver and extract and decode the observed data.]

NOTE: The following options [C.2.20(3) and C.2.20(4)] are not required for the OTF system operation. They would be used for differential code position interface to marine systems such as electronic charts or hydrographic survey systems.

- *[(3) Real time positional data out of the remote receiver will adhere to the NMEA 0183 data sentences format and will be output over an RS-232 compatible port.]
- *[(4) The receiver shall have the capability to output the data, position fixes, and calibration data through a RS-232 compatible serial port.]

[C.3. Not Used]

C.4. GPS Baseline Processing and Reduction Software.

C.4.1. General. The GPS baseline processing software must be fully compatible with the receivers listed in Paragraph C.2.

NOTE: If the computer processing system is NOT included as part of this solicitation, then the type of processor must be given to verify software compatibility.

C.4.2. Data Computations. The baseline reduction software shall compute, at a minimum, *[the carrier-phase integer cycle ambiguity using static and kinematic techniques, including those commonly known as "known baseline," "rapid static," "antenna swap," "stop-and-go," and "OTF"] *[and subsequently] the 3-dimensional differential baseline components between observation stations, within the accuracy specifications given in Paragraph C.1.

C.4.3. Ephemerides. The baseline computations must include options for using both the broadcast and precise ephemerides.

C.4.4. Output Data. The results of the baseline processing shall be in any user-selected form, such as *[geocentric coordinates,] *[state plane coordinates based on the North American Datum of ____], *[state plane coordinates based on the North American Datum of 1983,] *[and] *[or] *[Universal Transverse Mercator projection coordinates].

C.4.5. Batch Processing. The software shall have the capability to post-mission process data sets unattended in a batch mode.

C.4.6. Multiple Copies. The Government shall be allowed to operate the software simultaneously on *[_____] computer platforms.

C.4.7. Absolute Point Positioning. The software shall be capable of processing pseudorange data to obtain single point positions of a single receiver.

*[C.4.8. Real-Time Capability. The software shall be capable of resolving carrier cycle integer ambiguities in real time when the observing stations are connected via a communications link *[as specified elsewhere in this solicitation] using the computational procedure given in Paragraph C.4.2., and subsequently compute 3-dimensional differential baseline components.]

*[C.4.9. Real-Time Output. The results of the real-time baseline processing shall be in any user-selected form, such as geocentric coordinates, state plane coordinates based on the North American Datum of 19XX, or Universal Transverse Mercator projection coordinates. The results will be time tagged with an accuracy of 50 msec, at the time of signal reception at the antenna. The results will be written to a memory device *[both]*[internal and] external to the device performing the computations and shall be sent to an external computer system, at the selection of the user.]

C.4.10. Updates. All baseline processing software updates shall be provided for a period of *[4] years from the date of delivery.

C.5. Network Adjustment Software.

C.5.1. The network adjustment software shall allow for the direct input of data from the post-mission processing software specified in Paragraph C.4. The adjustment software shall include routines to easily edit, correct, manipulate, and output results. The software shall have the capability of simultaneously adjusting a minimum of *[1,000] [_____] observations.

C.5.2. The network adjustment software shall be based on the theory of least-squares. It shall be capable of performing both minimally and fully constrained adjustments. Output statistics shall include relative line (distance) accuracies between all points in the network and point confidence limits for each point in the network. Normalized residuals shall be displayed for all input vectors.

C.5.3. The network adjustment software shall transform geocentric coordinates and geographic coordinates to any user defined projection, such as the North American Datum of 1983 and 1927 state plane coordinate system.

C.5.4. Multiple Copies. The Government shall be allowed to operate the software simultaneously on *[_____] systems.

C.5.5. Updates. All baseline processing software updates shall be provided for a period of *[4] years from the date of delivery.

C.5.6. Geoid Modeling. The software shall include the *[Geoid xx] [most recent geoid] model available to the public from the National Geodetic Survey.

*[C.5.7. The network adjustment software shall accept and incorporate data from conventional survey methods such as angles, distance, and elevation differences.]

C.6. Data Link for Real-Time Applications.

C.6.1. The data link shall be completely functionally integrated with the receivers and processors procured under this solicitation. This includes the incorporation of modems for the complete interface of radio to processor/receiver.

C.6.2. The data link shall provide data from the reference station to the "roving" station to allow the system to compute positions of the roving station using a kinematic processing technique, as specified in Paragraph C.1. of this

solicitation, at a rate of at least one position per second, with no more than one (1) percent loss of position data. The data link equipment shall be identical at both stations to allow transmission from the "roving" station to the reference station. The kinematic processing technique shall not be a function of the data link used. The data link shall transmit all receiver raw observables, as specified in Paragraph C.2. of this solicitation, to the other receiver used in the differential GPS system.

C.6.3. *[The data link system shall operate at the *[frequency of _____]*[frequencies of ____ ____]]. *[The data link shall operate at a frequency that does not require license for use.] *[The data link shall utilize a commercially available carrier phase broadcast that follows the criteria found elsewhere in Section C of this specification. The proposal will include a fee schedule for prescription and monthly service.]

NOTE: The frequency used for a VHF broadcast must be coordinated with the FOA frequency manager. Modulation rates and/or channel bandwidth requirements also may have to be specified. The unlicensed frequency will also be low power, hence, very short range. Optional cellular phone or geostationary satellite data links may also be specified.

*[C.6.4. The data link shall have an omnidirectional broadcast range of *[8]*[16]*[24]*[32]*[40] km (*[5]*[10]*[15]*[20]*[25] miles) and maintain the positioning capability stated in Paragraph C.6.2.]

*[C.6.5. A mounting kit shall be included to mount the data link antenna to a mast or range pole.]

*[C.6.6. The data link antenna shall be *[suitable for installation on small hydrographic survey launches (less than 7 m)] *[and]*[have an antenna cable of at least *[____] m]].

*[C.6.7. Power Supply. The data link (including modem) shall operate on the same power source as the GPS receiver.]

C.7. Training.

C.7.1. Upon delivery, the vendor shall provide training of at least *[4] days at *[location] *[to *[4] persons] on the operation of all software and hardware delivered as part of this contract.

*[C.7.2. At a future date, determined by the contracting officer based on coordination with the vendor, and not exceeding 6 months after delivery, the vendor will give an additional *[2] days training at *[location].]

C.8. Miscellaneous Requirements.

C.8.1. All power cables, computer cables, and any other item not mentioned in these specifications needed to make this equipment fully operable shall be furnished as part of this contract.

*[C.8.2. Ruggedized shipping containers shall be furnished for all hardware delivered under this solicitation.]

*[C.8.3. Survey Planning. Survey planning software shall be provided that, as a minimum, includes the following items: tabular and graphic satellite rise/set times, elevations, and azimuths for user-specified geographic locations and times; sky plots of SV positions with provisions for plotting satellite obstructions on the screen; listing of GDOP, PDOP, HDOP, and VDOP; and the selection of specific SV constellations to support in-depth kinematic survey planning.

*[C.8.4. All *[hardware]*[and]*[software] updates will be provided to the Government for a period of * [____] years from the date of delivery, free of charge or delivery cost.]

*[C.8.5. The vendor shall provide repair and maintenance of all hardware delivered under this solicitation for a period of * [____ (-)] years, free of charge.]

NOTE: At this point, other unique items may be added to the requirements if called for and/or requiring specification in Section B. Any specific vessel installation requirements for receivers, data links or antenna should be added. As-built vessel drawings or installation sketches should be attached to the contract. If DGPS is to be integrated with an existing navigation and/or survey system, manuals, drawings, etc. associated with that system should be referenced and attached at the appropriate contract section. Both hardware and software connections and modifications to the existing system must be detailed if such effort is to be an item of work under this contract.

Section D
Packaging and Marking

D.1. Preparation for Delivery. The system shall be packaged for shipment in accordance with the supplier's standard commercial practice.

D.2. Packaging and Marking. Packaging shall be accomplished so that the materials will be protected from handling damage. Each package shall contain a properly numbered, dated, and signed transmittal letter or shipping form, in duplicate, listing the materials being transmitted. Shipping labels shall be marked as follows:

US Army Engineer District, _____
ATTN: {include office symbol and name}
Contract No. _____
[Street/PO Box] {complete local mailing address}

Section E
Inspection and Acceptance

*E.1. Acceptance Test. All equipment and related components obtained under these specifications shall be fully certified prior to contract award as meeting the performance and accuracy in Section C. *[Any test previously performed for the Federal Geodetic Control Subcommittee (FGCS) will be acceptable for such certification by the vendor; otherwise the vendor shall be required to demonstrate, at the vendor's expense, the acceptability of the system in the manner prescribed in Paragraph E.2. If the FGCS test is to be used in lieu of a demonstration acceptance test, all results from the FGCS test shall be supplied to the contracting officer for evaluation by technical personnel.]

*E.2. Final Acceptance Test. At the option of the Government, a final acceptance test will be performed to demonstrate total system conformance with the technical specifications and requirements in Section C.

E.2.1. The acceptance test will be conducted with the system operating in the modes stated in Paragraph C.1. of this solicitation.

E.2.2. The DGPS positional accuracy will be tested against the accuracy and ranges specified in Paragraph C.1. of this solicitation. The resultant DGPS accuracy will be evaluated with the 95% error statistic. Inaccuracies in the comparative testing network / system will be properly allowed for in assessing the test results.

E.2.3. Final acceptance testing will be performed at *[the point of delivery indicated in Section D] *[_], and will be performed within *[_] days after delivery. The supplier will be notified of the results within *[_] days after delivery. If the equipment fails to meet the acceptance test(s), the supplier will be given *[_] days after notification thereof to make any modification(s) necessary to enable retesting. The supplier will be notified of the place, date, and time of testing and, at his option, may send a representative to attend such tests.

E.2.4. If after a second test, the system fails to perform in accordance with the technical specifications, the Government will *[_].

E.3. Warranty Provisions. For *[1] year after delivery by the vendor, all equipment failures, other than those due to abuse, shall be corrected free of charge. Equipment shall be repaired within 5 working days of receipt at the repair facility, or loaner equipment will be provided at no expense to the Government until repairs are completed and the equipment has been returned to the district. The cost of shipping equipment to the vendor for repair shall be paid by the Government while the vendor will pay for returning the equipment to the District.

Section F
Deliveries or Performance

F.1. Delivery and final acceptance of all equipment shall be made within *[_] days after contract award. Delivery shall be made at the USACE facilities at the address identified in Paragraph D.2. of this solicitation. Final acceptance will depend upon all equipment meeting all requirements specified in this contract.

F.2. The contractor shall deliver all material and articles for shipment in a manner that will ensure arrival at the

specified delivery point in satisfactory condition and that will be acceptable to carriers at the lowest rates. The contractor shall be responsible for any and all damage until the equipment is delivered to the Government.

NOTE: The following is a list of hardware and software items/options that should be provided by bidders to determine their capability of providing an adequate DGPS-based positioning system. These items should be tailored to specific system requirements as developed in Section C of this solicitation, and would be used only when technical proposals are being evaluated.

GPS Receivers.

- Signal levels .
- Operation without cryptographic keys.
- Observables.
- Measurement time tags.
- Carrier phase signals and accuracy.
- Code phase signals and accuracy.
- Receiver output.
- Receiver data rate.
- PPS output.
- Internal receiver testing.
- Reinitialization.
- Multiple satellite tracking.
- Operating conditions.
- 5 deg SV acquisition.
- Humidity range.
- Temperature range.
- Waterproof.
- Corrosion resistance.
- Power requirements.
- Surge protection.
- Power transfer from AC to DC and reverse.
- Low power warning.
- External power source.
- Battery pack.
- Charge/recharge capacity.
- Battery connections/cables.
- Manuals.
- Field planning software.
- Dimensions.
- Weight.
- Data logging device.
- RTCM output.
- RTCM input.
- Waypoints.
- Position update rate.
- Velocity output.
- Antenna.
- 5/8-in. by 11-in. mounting.
- Phase center stability.
- Cable length and quantity.
- Frequency reception.
- Environmental considerations.
- Waterproof.
- Antenna pole.
- Tribrach.
- Vehicle mount.
- Input/Output ports.
- RS-232 standard.
- Compatibility with other components.
- NMEA position string.
- Serial port.

Computer Processing Systems.

- Software/hardware compatibility.

- Operating system.
- Processor chip.
- Clock speed.
- Hard drive capacity and access speed.
- Random access memory.
- CD-RW drive.
- VGA graphics adapter.
- Power source.
- Four extra serial ports (in addition to a mouse port).

Baseline Processing Software.

- Compatibility with receivers and computers.
- Data computations.
- Ephemerides.
- Output data.
- Batch processing.
- Multiple copies.
- Absolute point positioning.
- Real-time output.
- Updates.

Network Adjustment Software.

- Compatibility with other software supplied.
- 100 station minimum.
- Theory of Least-Squares.
- Transformation capability.
- Multiple copies.
- Updates.
- Conventional survey data input.

Data Link for Real-Time Application.

- Compatibility with receivers and computers.
- 1-sec update rate.
- Transmission of raw observables.
- Frequency.
- Broadcast range.
- Data loss (less than 1 percent).
- Mounting kit.
- Power supply.

Training and Technical Support.

- At delivery.
- At future date.
- Software upgrades.

Miscellaneous Requirements.

- Cables, etc.
- Shipping containers.
- Survey planning software.
- Hardware and software updates.
- Maintenance and repair.

Chapter 8 Planning Data Collection with GPS

8-1. Scope

GPS surveying techniques are used to establish primary control and topographic feature mapping for USACE civil and military projects. Operational and procedural specifications for performing GPS surveys are a function of the accuracy required for a specific project or map product. To accomplish these surveys in the most efficient and cost-effective manner, and ensure that the required accuracy criteria are obtained, a detailed survey planning phase is essential. This chapter primarily focuses on survey design criteria (and related observing specifications) required to establish accurate horizontal and vertical control for USACE military construction and civil works projects. Planning considerations for mapping grade surveys using resource grade receivers are also covered; however, since these types of surveys are usually performed in near real-time or real-time, they require less mission planning.

8-2. General Planning Considerations for GPS Surveys

A number of factors need to be considered during the planning phase of a proposed GPS data collection survey. These include:

- Project Application--Purpose of Data Collection Survey
 - establishing primary control for subsequent location, topographic, hydrographic, or utility survey
 - general site plan, feature mapping, or GIS densification survey
 - number of horizontal points or benchmarks required or to be occupied
 - datum -- horizontal and vertical
- Accuracy Requirements
 - horizontal and vertical
 - will GPS provide the necessary accuracy
- Equipment Resources
 - In-house or contract
 - GPS receiver availability
 - other auxiliary equipment availability
- GPS Procedure
 - high accuracy--use centimeter-level static or kinematic carrier phase
 - medium accuracy--use meter-level code phase
 - low Accuracy--use 10-30 meter-level absolute positioning
 - RTK options for topographic mapping
- Network Design and Connections
 - static baseline connections to local project control
 - connections to NGRS/CORS points
 - code phase connections with wide-area commercial, USCG, or FAA WAAS networks

- Data Collection and Adjustment Techniques
 - feature, attribute, and format requirements
 - data collection session time
 - GPS initialization and calibration requirements
 - multiple/repeat baseline requirements
 - loop requirements
 - other quality control requirements
 - adjustment criteria and accuracy standards
 - metadata requirements
 - final survey report format

- Site Access and Restrictions
 - reconnaissance survey required
 - potential visibility restrictions or multipath problems

- Funding Considerations (impacts many of the above factors)

The above list is not exhaustive--numerous other project-specific conditions need to be considered. The following sections in this chapter attempt to address most of these planning considerations.

8-3. Project Control Function and Accuracy

The first step in planning GPS control surveys is to determine the ultimate accuracy requirements. Survey accuracy requirements are a direct function of specific project functional needs; that is, the basic requirements needed to support planning, engineering design, maintenance, operations, construction, or real estate. This is true regardless of whether GPS or conventional surveying methods are employed to establish project control. Most USACE military and civil works engineering/construction activities require relative accuracies (i.e. accuracies between adjacent control points) ranging from 1:1,000 to 1:50,000, depending on the nature and scope of the project. Few USACE projects demand relative positional accuracies higher than the 1:50,000 level (Second-Order, Class I). Since the advent of GPS survey technology, there has been a tendency to specify higher accuracies than necessary. Specifying higher accuracy levels than those minimally required for the project can unnecessarily increase project costs. Guidance on project accuracy requirements can be found in Table 8-1. This table provides recommended accuracies for features on various types of military and civil works projects. Similar guidance is also found in Part 4 of the *FGDC Geospatial Positioning Accuracy Standards* (FGDC 2002). Feature tolerances are abbreviated as metric (SI) or English inch-pound (IP) units.

Table 8-1. Recommended Accuracies and Tolerances for Engineering, Construction, and Facility Management

Project or Activity	Target Map Scale SI/IP	Feature Position Tolerance		Contour Interval SI/IP
		Horizontal SI/IP	Vertical SI/IP	
DESIGN, CONSTRUCTION, OPERATION & MAINTENANCE OF MILITARY FACILITIES				
Maintenance and Repair (M&R)/Renovation of Existing Installation Structures, Roadways, Utilities, Etc				
General Construction Site Plans & Specs:	1:500	100 mm	50 mm	250 mm
Feature & Topographic Detail Plans	40 ft/in	0.1-0.5 ft	0.1-0.3 ft	1 ft
Surface/subsurface Utility Detail Design Plans	1:500	100 mm	50 mm	N/A
Elec, Mech, Sewer, Storm, etc	40 ft/in	0.2-0.5 ft	0.1-0.2 ft	
Field construction layout		0.1 ft	0.01-0.1 ft	
Building or Structure Design Drawings	1:500	25 mm	50 mm	250 mm
	40 ft/in	0.05-0.2 ft	0.1-0.3 ft	1 ft
Field construction layout		0.01 ft	0.01 ft	
Airfield Pavement Design Detail Drawings	1:500	25 mm	25 mm	250 mm
	40 ft/in	0.05-0.1 ft	0.05-0.1 ft	0.5-1 ft
Field construction layout		0.01 ft	0.01 ft	
Grading and Excavation Plans	1:500	250 mm	100 mm	500 mm
Roads, Drainage, Curb, Gutter etc.	30-100 ft/in	0.5-2 ft	0.2-1 ft	1-2 ft
Field construction layout		1 ft	0.1 ft	
Recreational Site Plans	1:1,000	500 mm	100 mm	500 mm
Golf courses, athletic fields, etc.	100 ft/in	1-2 ft	0.2-2 ft	2-5 ft
Training Sites, Ranges, and Cantonment Area Plans	1:2,500	500 mm	1,000 mm	500 mm
	100-200 ft/in	1-5 ft	1-5 ft	2 ft
General Location Maps for Master Planning	1:5,000	1,000 mm	1,000 mm	1,000 mm
AM/FM and GIS Features	100-400 ft/in	2-10 ft	1-10 ft	2-10 ft
Space Management Plans	1:250	50 mm	N/A	N/A
Interior Design/Layout	10-50 ft/in	0.05-1 ft		
As-Built Maps: Military Installation		100 mm	100 mm	250 mm
Surface/Subsurface Utilities (Fuel, Gas, Electricity, Communications, Cable, Storm Water, Sanitary, Water Supply, Treatment Facilities, Meters, etc.)	1:1000 or 50-100 ft/in (Army) 1:500 or 50 ft/in (USAF)	0.2-1 ft	0.2 ft	1 ft
Housing Management GIS (Family Housing, Schools, Boundaries, and Other Installation Community Services)	1:5,000 100-400 ft/in	10,000 mm 10-15 ft	N/A	N/A
Environmental Mapping and Assessment Drawings/Plans/GIS	1:5,000 200-400 ft/in	10,000 mm 10-50 ft	N/A	N/A

Table 8-1. Recommended Accuracies and Tolerances for Engineering, Construction, and Facility Management (continued)

Project or Activity	Target Map Scale SI/IP	Feature Position Tolerance		Contour Interval SI/IP
		Horizontal SI/IP	Vertical SI/IP	
Emergency Services Maps/GIS Military Police, Crime/Accident Locations, Post Security Zoning, etc.	1:10,000 400-2000 ft/in	25,000 mm 50-100 ft	N/A	N/A
Cultural, Social, Historical Plans/GIS	1:5000 400 ft/in	10,000 mm 20-100 ft	N/A	N/A
Runway Approach and Transition Zones: General Plans/Section Approach maps Approach detail	1:2,500 100-200 ft/in 1:5,000 (H) 1:5,000 (H)	2,500 mm 5-10 ft 1:1,000 (V) 1:250 (V)	2,500 mm 2-5 ft	1,000 mm 5 ft
<u>DESIGN, CONSTRUCTION, OPERATIONS AND MAINTENANCE OF CIVIL TRANSPORTATION & WATER RESOURCE PROJECTS</u>				
Site Plans, Maps & Drawings for Design Studies, Reports, Memoranda, and Contract Plans and Specifications, Construction plans & payment				
General Planning and Feasibility Studies, Reconnaissance Reports	1:2,500 100-400 ft/in	1,000 mm 2-10 ft	500 mm 0.5-2 ft	1,000 mm 2-10 ft
Flood Control and Multipurpose Project Planning, Floodplain Mapping, Water Quality Analysis, and Flood Control Studies	1:5,000 400-1000 ft/in	10,000 mm 20-100 ft	100 mm 0.2-2 ft	1,000 mm 2-5 ft
Soil and Geological Classification Maps	1:5,000 400 ft/in	10,000 mm 20-100 ft	N/A	N/A
Land Cover Classification Maps	1:5,000 400-1,000 ft/in	10,000 mm 50-200 ft	N/A	N/A
Archeological or Structure Site Plans & Details (Including Non-topographic, Close Range, Photogrammetric Mapping)	1:10 0.5-10 ft/in	5 mm 0.01-0.5 ft	5 mm 0.01-0.5 ft	100 mm 0.1-1 ft
Cultural and Economic Resource Mapping Historic Preservation Projects	1:10,000 1000 ft/in	10,000 50-100 ft	N/A	N/A
Land Utilization GIS Classifications Regulatory Permit Locations	1:5,000 400-1000 ft/in	10,000 mm 50-100 ft	N/A	N/A
Socio-Economic GIS Classifications	1:10,000 1000 ft/in	20,000 mm 100 ft	N/A	N/A
Grading & Excavation Plans	1:1,000 100 ft/in	1,000 mm 0.5-2 ft	100 mm 0.2-1 ft	1,000 mm 1-5 ft
Flood Control Structure Clearing & Grading Plans (e.g., revetments)	1:5,000 100-400 ft/in	2,500 mm 2-10 ft	250 mm 0.5 ft	500 mm 1-2 ft

Table 8-1. Recommended Accuracies and Tolerances for Engineering, Construction, and Facility Management (continued)

Project or Activity	Target Map Scale SI/IP	Feature Position Tolerance		Contour Interval SI/IP
		Horizontal SI/IP	Vertical SI/IP	
Federal Emergency Management Agency Flood Insurance Studies	1:5,000 400 ft/in	1,000 mm 20 ft	250 mm 0.5 ft	1,000 mm 4 ft
Locks, Dams, & Control Structures Detail Design Drawings	1:500 20-50 ft/in	25 mm 0.05-1 ft	10 mm 0.01-0.5 ft	250 mm 0.5-1 ft
Spillways & Concrete Channels Design Plans	1:1,000 50-100 ft/in	100 mm 0.1-2 ft	100 mm 0.2-2 ft	1,000 mm 1-5 ft
Levees and Groins: New Construction or Maintenance Design Drawings	1:1,000 100 ft/in	500 mm 1-2 ft	250 mm 0.5-1 ft	500 mm 1-2 ft
Construction In-Place Volume Measurement Granular cut/fill, dredging, etc.	1:1,000 40-100 ft/in	500 mm 0.5-2 ft	250 mm 0.5-1 ft	N/A
Beach Renourishment/Hurricane Protection Project Plans	1:1,000 100-200 ft/in	1,000 mm 2 ft	250 mm 0.5 ft	250 mm 1 ft
Project Condition Survey Reports Base Mapping for Plotting Hydrographic Surveys: line maps or aerial plans	1:2,500 200-1,000 ft/in	10,000 mm 5-50 ft	250 mm 0.5-1 ft	500 mm 1-2 ft
Dredging & Marine Construction Surveys New Construction Plans	1:1,000 100 ft/in	2,000 mm 6 ft	250 mm 1 ft	250 mm 1 ft
Maintenance Dredging Drawings	1:2500 200 ft/in	5,000 mm 15 ft	500 mm 2 ft	500 mm 2 ft
Hydrographic Project Condition Surveys	1:2500 200 ft/in	5,000 mm 16 ft	500 mm 2 ft	500 mm 2 ft
Hydrographic Reconnaissance Surveys	-	5,000 mm 15 ft	500 mm 2 ft	250 mm 2 ft
Offshore Geotechnical Investigations Core Borings /Probing/etc.	-	5,000 mm 5-15 ft	50 mm 0.1-0.5 ft	N/A

Table 8-1. Recommended Accuracies and Tolerances for Engineering, Construction, and Facility Management (continued)

Project or Activity	Target Map Scale SI/IP	Feature Position Tolerance		Contour Interval SI/IP
		Horizontal SI/IP	Vertical SI/IP	
Structural Deformation Monitoring Studies/Surveys				
Reinforced Concrete Structures: Locks, Dams, Gates, Intake Structures, Tunnels, Penstocks, Spillways, Bridges	Large-scale vector movement diagrams or tabulations	10 mm 0.03 ft (long term)	2 mm 0.01 ft	N/A
Earth/Rock Fill Structures: Dams, Floodwalls	N/A	(same as above)	30 mm	15 mm
Levees, etc. -- slope/crest stability & alignment		0.1 ft (long term)	0.05 ft	
Crack/Joint & Deflection Measurements: piers/monoliths--precision micrometer	tabulations	0.2 mm 0.01 inch	N/A	N/A
<u>REAL ESTATE ACTIVITIES: ACQUISITION, DISPOSAL, MANAGEMENT, AUDIT</u>				
Maps, Plans, & Drawings Associated with Military and Civil Projects				
Tract Maps, Individual, Detailing				
Installation or Reservation Boundaries, Lots, Parcels, Adjoining Parcels, and Record Plats, Utilities, etc.	1:1,000 1:1,200 (Army) 50-400 ft/in	10 mm 0.05-2 ft	100 mm 0.1-2 ft	1,000 mm 1-5 ft
Condemnation Exhibit Maps	1:1,000 50-400 ft/in	10 mm 0.05-2 ft	100 mm 0.1-2 ft	1,000 mm 1-5 ft
Guide Taking Lines/Boundary Encroachment Maps: Fee and Easement Acquisition	1:500 20-100 ft/in	50 mm 0.1-1 ft	50 mm 0.1-1 ft	250 mm 1 ft
General Location or Planning Maps	1:24,000 2,000 ft/in	10,000 mm 50-100 ft	5,000 mm 5-10 ft	2,000 mm 5-10 ft
GIS or LIS Mapping, General				
Land Utilization and Management, Forestry Management, Mineral Acquisition	1:5,000 200-1,000 ft/in	10,000 mm 50-100 ft	N/A	N/A
Easement Areas and Easement Delineation Lines	1:1,000 100 ft/in	50 mm 0.1-0.5 ft	50 mm 0.1-0.5 ft	-

Table 8-1. Recommended Accuracies and Tolerances for Engineering, Construction, and Facility Management (concluded)

Project or Activity	Target Map Scale SI/IP	Feature Position Tolerance		Contour Interval SI/IP
		Horizontal SI/IP	Vertical SI/IP	
<u>HAZARDOUS, TOXIC, RADIOACTIVE WASTE (HTRW) SITE INVESTIGATION, MODELING, AND CLEANUP</u>				
General Detailed Site Plans HTRW Sites, Asbestos, etc.	1:500 5-50 ft/in	100 mm 0.2-1 ft	50 mm 0.1-0.5 ft	100 mm 0.5-1 ft
Surface Geotoxic Data Mapping and Modeling	1:500 20-100 ft/in	100 mm 1-5 ft	500 mm 1-2 ft	500 mm 1-2 ft
Contaminated Ground Water Plume Mapping/Modeling	1:500 20-100 ft/in	1,000 mm 2-10 ft	500 mm 1-5 ft	500 mm 1-2 ft
General HTRW Site Plans & Reconnaissance Mapping	1:2,500 50-400 ft/in	5,000 mm 2-20 ft	1,000 mm 2-20 ft	1,000 mm 2-5 ft

a. Project functional requirements. Project functional requirements must include planned and future design, construction, and mapping activities. Specific control density and accuracy are designed from these functional requirements.

(1) Density of control within a given project is determined from factors such as planned construction, site plan mapping scales, master plan mapping scale, and dredging and hydrographic survey positioning requirements.

(2) The relative accuracy for project control is also determined based on mapping scales, design/construction needs, type of project, etc., using guidance in Table 8-1 above. Most site plan mapping for design purposes is performed and evaluated relative to FGDC or American Society of Photogrammetry and Remote Sensing (ASPRS) standards--see references in Appendix A. These standards apply to photogrammetric mapping, total station mapping, and site plan mapping performed with GPS RTK techniques. Network control must be of sufficient relative accuracy to enable hired-labor or contracted survey forces to reliably connect their supplemental mapping work.

b. Minimum accuracy requirements. Project control surveys shall be planned, designed, and executed to achieve the minimum accuracy demanded by the project's functional requirements. In order to utilize USACE resources most efficiently, control surveys shall not be designed or performed to achieve accuracy levels that exceed the project requirements. For instance, if a Third-Order, Class I accuracy standard (1:10,000) is required for dredge/survey control on a navigation project, field survey criteria shall be designed to meet this minimum standard.

c. Achievable GPS accuracy. As stated previously, GPS survey methods are capable of providing significantly higher relative positional accuracies with only minimal field observations, as compared with conventional triangulation, trilateration, or EDM traverse. Although a GPS survey may be designed and performed to support lower accuracy project control requirements, the actual results could generally be several magnitudes better than the requirement. Although higher accuracy levels are

relatively easy to achieve with GPS, it is important to consider the ultimate use of the control on the project in planning and designing GPS control networks. Thus, GPS survey adequacy evaluations should be based on the project accuracy standards, not those theoretically obtainable with GPS.

(1) For instance, an adjustment of a pair of GPS-established points may indicate a relative distance accuracy of 1:800,000 between them. These two points may be subsequently used to set a dredging baseline using 1:2,500 construction survey methods; and from 100-ft-spaced stations on this baseline, cross sections are projected using 1:500 to 1:1,000 relative accuracy methods (typical hydrographic surveys). Had the GPS-observed baseline been accurate only to 1:20,000, such a closure would still have easily met the project's functional requirements.

(2) Likewise, in topographic (site plan) mapping or photogrammetric mapping work, the difference between 1:20,000 and 1:800,000 relative accuracies is not perceptible at typical USACE mapping/construction scales (1:240 to 1:6,000), or ensuring supplemental compliance with ASPRS Standards. In all cases of planimetric and topographic mapping work, the primary control network shall be of sufficient accuracy such that ASPRS Standards can be met when site plan mapping data are derived from such points. For most large-scale military and civil mapping work performed by USACE, Third-Order relative accuracies are adequate to control planimetric and topographic features within the extent of a given sheet/map or construction site. On some projects covering large geographical areas (e.g., reservoirs, levee systems, installations), this Third-Order mapping control may need to be connected to/with a higher-order NGRS network to minimize scale distortions over longer reaches of the project.

(3) In densifying control for GIS databases, the functional accuracy of the GIS database must be kept in perspective with the survey control requirements. Performing 1:100,000 accuracy surveys for a GIS level containing 1-acre cell definitions would not be cost-effective; sufficient accuracy could be obtained by scaling relative coordinates from a US Geological Survey (USGS) quadrangle map.

d. Vertical accuracy. Establishing primary (i.e. monumented) vertical control benchmarks using carrier phase differential GPS methods requires considerable planning if traditional vertical accuracy standards are to be met. Since most Corps projects involve hydraulic flow of water in rivers, streams, pools, wetlands, etc., precise vertical control is essential within a project area; especially if construction is planned. Densification of vertical elevations with GPS requires sufficient control checks using conventional differential leveling, along with accurate geoid modeling. Therefore, an early evaluation needs to be made to determine if GPS-derived elevations will be of sufficient accuracy to meet project needs. Usually, a combination of GPS and conventional differential spirit leveling will be required. GPS standards and specifications needed to establish and densify vertical control network points are discussed in a later section of this chapter.

8-4. Selection of a GPS Survey Technique

Once a control project's accuracy requirement has been established, then the basic survey technique needed to meet this accuracy can be specified. The technique may or may not include GPS methods, or may require a combination of terrestrial (e.g., leveling and total station) methods and GPS. Depending on the accuracy requirements, either carrier phase or code phase GPS techniques may be selected. In general, monumented control points should be tied in using carrier phase methods--typically using static baseline connections to NGRS points. Some kinematic survey techniques (e.g., stop-and go, pseudo-kinematic) may also be employed to establish primary control when centimeter-level accuracy is required. External network connections and internal connections between monuments within the project area shall be performed using the network design guidance contained in the following sections of this chapter. Code phase techniques are more applicable to real-time, lower-order accuracy (meter-level) mapping projects, such as hydrographic surveying, GIS mapping, wetland delineation, shoreline delineation, etc.

8-5. Planning Differential Code Phase GPS Surveys

Meter-level accuracy code phase observations may be suitable for lower accuracy surveys, such as topographic feature mapping or real-time hydrographic surveys. Code phase observations should not be used for placing control on project monuments, nor should it be used for elevation measurement. Wide area differential code phase observations are easily achieved relative to NGRS stations that have supplemental communications to broadcast pseudorange corrections. These include FAA WAAS, USCG, and commercial systems. Since the distance from the broadcast points can significantly effect the ultimate positional accuracy, one should consult maps or web sites from the code phase provider to determine whether the distance is within acceptable limits (e.g., less than 150 miles for USCG sites and greater for systems that model over multiple stations).

a. DGPS providers. A real-time dynamic code-phase DGPS positioning system includes a reference station (master), communications link, and user (remote) equipment. If results are not required in real-time, the communications link could be eliminated and the positional information post-processed; however, such an operation is not practical for most construction support activities where immediate results are necessary. Since there are several DGPS services (USCG, FAA WAAS, and commercial subscription services) that provide real-time pseudorange corrections, it is recommended that these services be used before installing or using a local DGPS system. Only in circumstances where these services do not provide coverage should a local DGPS system be used.

b. Reference station. The reference station measures timing and ranging information broadcast by the satellites and computes and formats pseudorange corrections (PRC) for broadcast to the remote equipment. The reference station system typically consists of a GPS receiver, antenna, and processor. Using differential pseudoranging, the position of the user is found relative to the reference station. The pseudoranges are collected by the GPS receiver and transferred to the processor where pseudorange corrections are computed and formatted for data transmission. Many manufacturers have incorporated the processor within the GPS receiver, eliminating the need for an external processing device. The reference station processor computes the PRC and formats the corrections for the communications link to transmit to the remote unit or a survey vessel. The data transmission format is typically the Radio Technical Commission for Maritime Services Special Committee 104 (RTCM SC-104). The reference station processor may also be designed to perform quality assurance and integrity functions. This routine is required to determine the validity and quality of the computed PRCs. The reference station processor should be capable of computing and formatting PRC every 1 to 3 sec.

c. Reference station placement. The reference station is placed on a known survey monument in an area having an unobstructed view of the sky for at least 10 deg above the horizon. The antenna should not be located near objects that will cause multipath or interference. Areas with antennas, microwave towers, power lines, and reflective surfaces should be avoided.

d. Communications link. The communications link is used as a transfer media for the differential corrections. The main requirement of the communications link is that transmission be at a minimum rate of 200 bits per second (bps). Higher rates are required for wide-area networks. The type of communications system is dependent on the user's requirements.

e. Ultra high frequency (UHF) and very high frequency (VHF). Communications links operating at UHF and VHF are viable systems for the broadcast of DGPS corrections. VHF and UHF can extend out some 20 to 50 km, depending on local conditions. The disadvantages of UHF and VHF links are their limited range to line of sight and the effects of signal shadowing (from islands, structures, and buildings), multipath, and licensing issues.

f. Frequency authorization. Most RF communications links necessitate a reserved frequency for operation to avoid interference with other activities in the area. Transmitters with power outputs below 100 milliwatts (mW) do not require a frequency allocation and license for operation in the United States. Frequency authorization for the USACE must be obtained through the National Telecommunications and Information Administration (NTIA) of the US Department of Commerce for transmissions that exceed 100 mW. A district's frequency manager handles authorization and allocation of a frequency. No transmission can occur over a frequency until the frequency has been officially authorized for use. This procedure applies to all government agencies.

g. Satellite communications. There are several companies that sell satellite communications systems that can be used for the transmission of the PRCs. These systems are not as limited in range as a UHF/VHF system can be, but are usually higher in price.

h. User equipment. The user equipment is the most flexible facet of real-time code phase tracking DGPS. The remote receiver should be, at minimum, a multi-channel single-frequency (L1) C/A-code GPS receiver. The receiver must be able to accept the differential corrections from the communications link in the RTCM SC-104 format (see Chapter 7), and then apply those corrections to the measured pseudorange. The critical portion of the user equipment is the receiver update rate. Specific requirements will vary with different manufacturers and with the distance from the reference station. The output from the rover receiver should be in the NMEA 0183 format (see Chapter 7), because it is the most widely used standard for input into external devices, such as a hydrographic survey software package. For hydrographic applications, the user equipment also must be capable of maintaining positional tolerances for surveys at speeds of 7 to 10 knots. A DGPS receiver must not bias the position during vessel turns due to excess filtering.

i. Separation distances. In order to maintain meter-level positional accuracy tolerances, the maximum separation distance between a reference and remote station should generally not exceed 300 km, provided that differential tropospheric and ionospheric corrections are used. These corrections are not always applied to internal solutions on GPS receivers. The unaccounted tropospheric and ionospheric errors can contribute to horizontal position error on an average of 0.7 to 1.0 m per 100 km. A limiting factor of the separation distance is the type of data link used. If a DGPS is procured for hydrographic surveying, the reference station should be capable of being moved from one point to another. This will allow the user to move the reference station so that the minimum distance separation requirements are maintained.

j. Satellite geometry. In code phase DGPS, the Horizontal Dilution of Position (HDOP) is the critical geometrical component. The HDOP should be < 4 for most types of real-time meter-level positioning applications. The GPS constellation will maintain a HDOP of approximately 2 to 3 most of the time. In addition, quality control procedures need to be developed to ensure that systematic biases are not present in code phase positioning systems. These quality control procedures are spelled out in EM 1110-2-1003 (Hydrographic Surveying).

8-6. Field Reconnaissance for GPS Surveys

A good advance reconnaissance of all marks and features within the project is crucial to the expedient and successful completion of a GPS survey. The site reconnaissance should ideally be completed during the planning stage. The surveyor should also prepare a site sketch and brief description on how to reach the point since the individual performing the site reconnaissance may not be the surveyor that returns to occupy the known or unknown station.

a. Project sketch. A project sketch should be developed before any site reconnaissance is performed. The sketch should be on a 7-1/2-minute USGS quadrangle map, or other suitable drawing. Drawing the sketch on the map will assist the planner in determination of site selections and travel distances between stations.

b. Station descriptions and recovery notes. Station descriptions for all new monuments will be developed as the monumentation is performed. The format of these descriptions will follow that stated in EM 1110-1-1002 (Survey Markers and Monumentation). Station "Recovery Notes" should be written for existing NGRS network stations and Corps project control points, as detailed in EM 1110-1-1002. Estimated travel times to all stations should be included in the description. Include road travel time, walking time, and GPS receiver breakdown and setup time. These times can be estimated while performing the initial reconnaissance. A site sketch shall also be made on the description/recovery form. Examples of site reconnaissance reports are shown in Figures 8-1 and 8-2. A blank reconnaissance report form is included as Worksheet 8-1 (Figure 8-3), which may be used in lieu of a standard field survey book.

c. Waypoint reconnaissance navigation. Waypoint navigation is an option on most receivers, allowing the user to enter a geodetic position (usually latitude and longitude) of points or existing control monuments the user may wish to locate. The GPS antenna/receiver, fastened to a vehicle, range pole, or backpack, can then provide the user with real-time navigational information. The navigational information may include the distance and bearing to the point of destination (stored in the receiver), the estimated time to destination, and the speed and course of the user. The resultant message produced can then be used to guide the user to the point of interest. Waypoint navigation is an option that, besides providing navigation information, may be helpful in the recovery of control stations that do not have descriptions. If the user has the capability of real-time code phase positioning, the way point navigational accuracy can be in the range of 0.5 - 5 m.

d. Site obstruction/visibility sketches. The individual performing the site reconnaissance of a potential GPS point to be occupied should record the azimuth and vertical angle of all obstructions. The azimuths and vertical angles should be determined with a compass and inclinometer. Because obstructions such as trees and buildings cause the GPS signal transmitted from the GPS satellite to be blocked, the type of obstruction is also an important item to be recorded. The type of obstruction is also important to determine if multipath may be a problem. Buildings with reflective surfaces, chain-link fences, and antenna arrays are objects that may cause multipath. The site obstruction data are used to determine if the survey site is suitable for GPS observations. Obstruction data should be plotted on a "Station Visibility Diagram," such as that shown in Figure 8-4. A blank copy of this form is provided as Worksheet 8-2 (Figure 8-5). Ideally all GPS stations should have an unobstructed view 15 degrees above the horizon. Satellites below 10 degrees from the horizon should not be observed.

e. Suitability for kinematic observations. Clear, obstruction-free projects may be suitable for kinematic GPS surveys, as opposed to less-productive static methods. The use of kinematic observations will increase productivity by a factor of 5 to 10 over static methods, while still providing adequate accuracy levels. On many projects, a mixture between both static and kinematic GPS observations may prove to be most cost-effective.

f. Monumentation. All monumentation should follow the guidelines of EM 1110-1-1002 (Survey Markers and Monumentation).

g. On-site physical restrictions. The degree of difficulty in occupying points due to such factors as travel times, site access, multipath effects, and satellite visibility should be anticipated. The need for redundant observations, should reobservations be required, must also be considered.

h. Checks for disturbed existing control. Additional GPS baselines may need to be observed between existing NGRS or Corps project control points to verify their accuracy and/or stability.

i. Satellite visibility limitations. For most of CONUS, there are at least 4-5 satellites in view at all times--usually more. However, some areas may have less during times of satellite maintenance, unhealthy satellites, or DoD realignments for tactical purposes. Satellite visibility charts, available in most mission planning software, play a major part in optimizing network configurations and observation schedules.

j. Station intervisibility requirements. Project specifications may dictate station intervisibility for azimuth reference. This may constrain minimum station spacing.

SITE RECONNAISSANCE/REPORT ON CONDITION OF SURVEY MARK

Project for Which Reconnaissance was Performed DWORSHAK DAM
 Station Name OROFINO Year Established 1933
 State Code ID County POTTER Map Scale 1:24,000
 Organization's Mark CIGS Map Sheet CLEARWATER
 Search Performed By K. SMITH Date 4/12/89
 Organization WALLA WALLA DISTRICT
 Exact Stamping OROFINO 1933 Condition GOOD

Please report on the thoroughness of the search in case the mark was not recovered. Suggest changes in description, need for repairing or moving the mark, or other pertinent facts. Record letters and numbers found stamped in (not cast in) the mark.

THE MARK WAS RECOVERED USING THE 1970
DESCRIPTION. ADDITIONAL DESCRIBED DATA:
THE MARK IS 89.7' W OF PP#6342, 62.4' NE OF AN 18"
MAPLE, 42.0' S OF A 10" SPRUCE AND 2'E OF AN ORANGE
WITNESS POST.
RECOVERED REFERENCE MARK OROFINO No.1 1933 GOOD
" " " OROFINO No.3 1970 GOOD

 TRAVEL TIME BY 2-WHEEL SKETCH
 DRIVE VEHICLE FROM
 CLEARWATER IS APPROX.
 15 MINUTES.

Figure 8-2. Reconnaissance survey sketch on notebook format

SITE RECONNAISSANCE/REPORT ON CONDITION OF SURVEY MARK

Project for Which Reconnaissance was Performed _____

Station Name _____ Year Established _____

State Code ____ County _____ Map Scale _____

Organization's Mark _____ Map Sheet _____

Search Performed By _____ Date _____

Organization _____

Exact Stamping _____ Condition _____

Please report on the thoroughness of the search in case the mark was not recovered. Suggest changes in description, need for repairing or moving the mark, or other pertinent facts. Record letters and numbers found stamped in (not cast in) the mark.

SKETCH



Figure 8-3. Worksheet 8-1, Site Reconnaissance Report

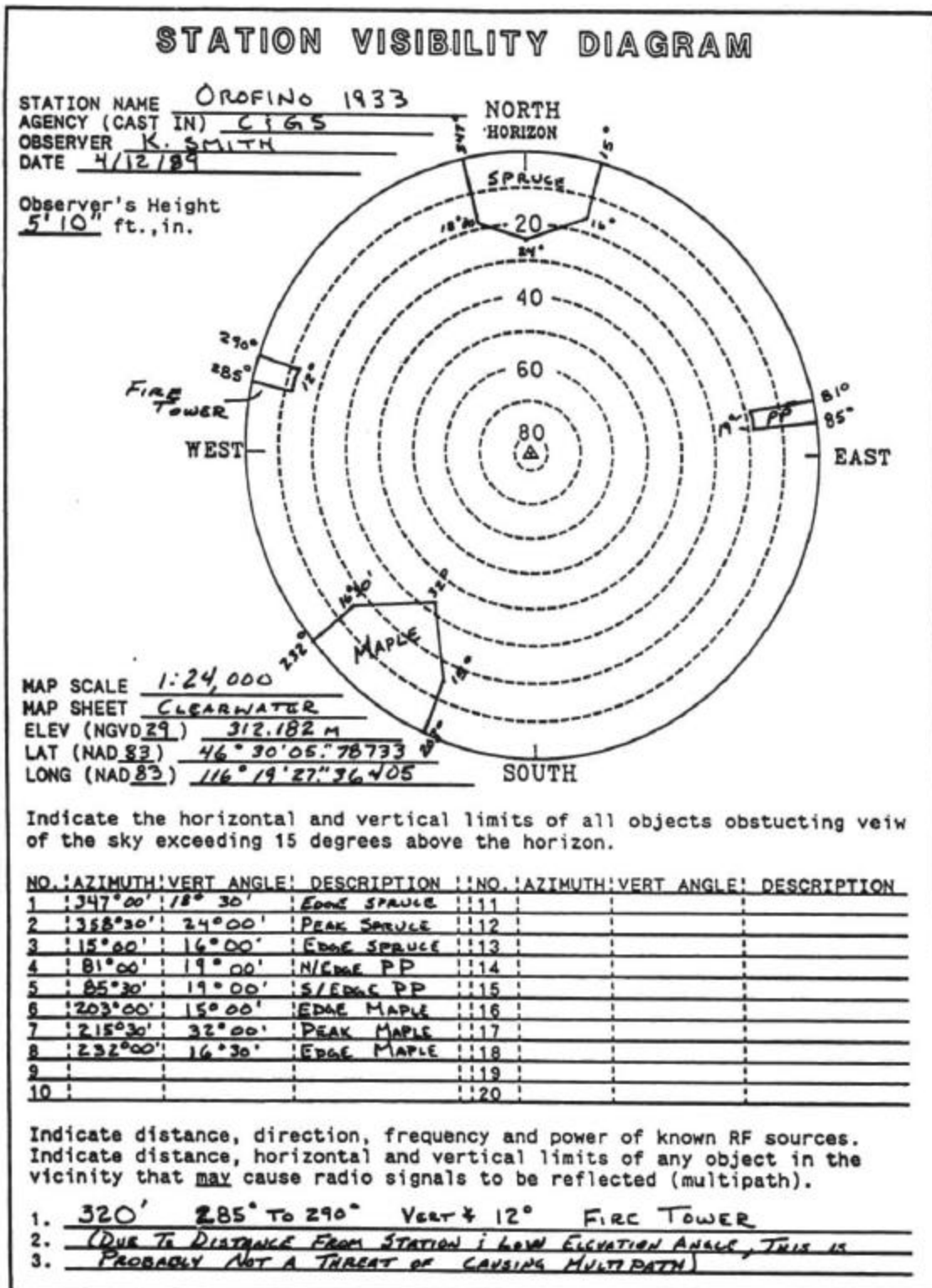

Figure 8-4. Typical example of a station visibility plot

STATION VISIBILITY DIAGRAM

STATION NAME _____ NORTH
 AGENCY (CAST IN) _____ HORIZON
 OBSERVER _____
 DATE _____

Observer's Height _____
 _____ ft., in.

MAP SCALE _____
 MAP SHEET _____
 ELEV (NGVD _____) _____
 LAT (NAD _____) _____
 LONG (NAD _____) _____ SOUTH

Indicate the horizontal and vertical limits of all objects obstructing view of the sky exceeding 15 degrees above the horizon.

NO.	AZIMUTH	VERT ANGLE	DESCRIPTION	NO.	AZIMUTH	VERT ANGLE	DESCRIPTION
1				11			
2				12			
3				13			
4				14			
5				15			
6				16			
7				17			
8				18			
9				19			
10				20			

Indicate distance, direction, frequency, and power of known RF sources. Indicate distance, horizontal and vertical limits of any object in the vicinity that may cause radio signals to be reflected (multipath).

1. _____
2. _____
3. _____

Figure 8-5. Worksheet 8-2, Station Visibility Diagram

8-7. Technical Criteria for Carrier Phase GPS Horizontal Control Surveys

Once a determination is made that high accuracy points are to be established on monumented project control, then, by default, carrier phase techniques are required. The National Geodetic Survey, in conjunction with the FGDC, has developed standards and specifications for performing static carrier phase DGPS surveys. One of these standards is universally recognized for performing DGPS surveys, namely:

"Geometric Geodetic Accuracy Standards and Specifications for using GPS Relative Positioning Techniques," (Version 5.0 dated 11 May 1988, Corrected to 1 August 1989), published by the Federal Geodetic Control Committee (FGCC), which now falls under the Federal Geographic Data Committee (FGDC)

Although this standard was developed for static GPS methods in 1988 before a full GPS constellation was available, many of the recommended techniques and criteria are still valid. Table 8-2 below contains recommended USACE standards for precise horizontal GPS surveys. It applies to both static and some kinematic techniques. It is synopsised from the FGCC 1988 standard but addresses Corps-specific DGPS techniques and criteria that are more relaxed and practical than the rigid FGCC 1988 standards. In addition, many of the higher-order NGRS network densification criteria in FGCC 1988 are not applicable to Corps military and civil works project control surveys. The following sections provide guidance for some, but not all, of the factors to be considered in designing a GPS network and planning subsequent observing procedures. The FGCC 1988 standard contains a more detailed discussion of many of these network design factors--this standard should be thoroughly reviewed by those involved in such a process. More detailed explanations of the FGCC 1988 criteria can also be found in various GPS textbooks listed in Appendix A--e.g., Van Sickle 2001.

Table 8-2. Minimum Standards for Horizontal Control Survey Design, Geometry, Connection, and Observing Criteria--Carrier Phase Differential GPS Surveys

Classification Order						
Criterion		1st	2nd, I	2nd, II	3rd, I	3rd, II
Relative Accuracy	ppm 1 part in	10 100k	20 50k	50 20k	100 10k	200 5k
General Criteria						
Required connections to existing NGRS network		Yes	Yes	W/F/P	W/F/P	W/F/P
Baseline observation check required over existing control		Yes	Yes	W/F/P	W/F/P	No
Number of connections with existing network (NGRS or Local)						
Minimum		3	2	2	2	2
Optimum		3+	3	3	3	3
Vertical		[see Table 8-4]
Max distance from network to nearest point in project (km)		50	50	50	50	50
Maximum distance to nearest CORS point		[no specified limit]
Field Observing Criteria						
Repeat baseline occupations--not less than 10% or at least		2	2	2	2	2
Loop closure requirements:						
Maximum number of baselines/loop		10	10	20	20	20
Maximum loop length, km, not to exceed		100	100	200	N/R	N/R
Loop misclosure, ppm, not more than		10	20	50	100	200
Spur baseline observations:						
Number of sessions/baseline		2	2	2	2	2
Required antenna height measurement per session		2	2	2	2	2
Dual-frequency L1/L2 observations required:						
< 20-km lines		Yes	No	No	No	No
> 20-km lines		Yes	Yes	Yes	Yes	Yes
Recommended elevation mask above horizon, degrees		15	15	15	15	15

Notes:

1. Abbreviations used in this table are explained as follows:

W/F/P--Where feasible and practical

N/R--No requirement for this specification--usually indicates variance with provisional FGCC GPS specifications

2. Classification orders refer to intended survey precision for USACE application, not necessarily FGDC standards designed to support national network densification.

a. Project size. The extent of the project will affect the GPS survey network shape. Many civil works navigation and flood control projects are relatively narrow in lateral extent but may extend for many miles longitudinally. Alternatively, military installations or reservoir/ recreation projects may project equally in length and breadth. The optimum GPS survey design will vary considerably for these different conditions. For higher-order surveys, Table 8-2 recommends that the project area shall be surrounded by optimally 3 connections to NGRS control, or more if precise vertical densification is being performed. For projects extending along linear waterway systems, far more NGRS connections will be required. Given the high density of NGRS/CORS stations in CONUS, this requirement is easily achieved for most projects other than coastal navigation sites. See also FGCC 1988 for further discussion.

b. Required density of control. The spacing of new points on a civil or military installation project needs to be assessed for each control survey, based on the supplemental purposes of the control

points (photogrammetric mapping control, GIS mapping control, construction, etc.). The type of GPS survey scheme used will depend on the number and spacing of points to be established, which again is a project-specific requirement. Often, a combination of static GPS, RTK GPS, and conventional survey densification will prove to be the most cost-effective approach.

c. Absolute GPS reference datums. Coordinate data for GPS baseline observations are referenced and reduced relative to WGS 84, an earth-centered (geocentric) coordinate system. As stated in Chapter 3, this system is not directly referenced to, but is closely related to (for all practical engineering survey purposes) GRS 80, upon which NAD 83 is related. GPS data reduction and adjustments are normally performed using the WGS 84 coordinate system (X-Y-Z), with baseline vector components ($\Delta X, \Delta Y, \Delta Z$) measured relative to this coordinate system. Although baseline vectors are measured relative to the WGS 84 system, for most USACE engineering and construction applications these data may be used in adjustments on NAD 27 (Clarke 1866 spheroid).

(1) If the external network being connected (and adjusted to) is the published NAD 83, the GPS baseline coordinates may be directly referenced on the GRS 80 ellipsoid since they are nearly equal. All supplemental control established is therefore referenced to the GRS 80/ NAD 83 coordinate system.

(2) If a GPS survey is connected to NAD 27 (State Plane Coordinate System of 1927, or SPCS 27) stations that were not adjusted to the NAD 83 datum, then these fixed points may be transformed to NAD 83 coordinates using high-level geodetic transformation routines, or approximately transformed using USACE program CORPSCON (see EM 1110-1-1004), and the baseline reductions and adjustment performed relative to the GRS 80 ellipsoid.

(3) Alternatively, GPS baseline connections to NAD 27 (SPCS 27) project control may be reduced and adjusted directly on that datum with resultant coordinates on the NAD 27. Refer to EM 1110-1-1004 regarding state plane coordinate transforms between SPCS 27 and SPCS 83 grids. Conversions of final adjusted points on the NAD 27 datum to NAD 83 may also be performed using CORPSCON. It is strongly recommended that all existing NAD 27 control be transformed to NAD 83 by direct baseline connection to NGRS points

(4) Ellipsoid heights " h " referenced to the GRS 80 ellipsoid differ significantly from the orthometric elevations " H " on NGVD 29, NAVD 88, or dynamic/hydraulic elevations on the IGLD 55-IGLD 85 systems. This difference (geoid separation, or " N ") can usually (but not always) be ignored for horizontal control surveys. This implies " N " is assumed to be zero and " $h = H$ " where the elevation may be measured, estimated, or scaled at the fixed point(s).

(5) Datum systems other than NAD 27/NAD 83 will be used in OCONUS locations. Selected military operational requirements in CONUS may also require non-NAD datum references. It is recommended that GPS baselines be directly adjusted on the specific project datum. Most survey-grade GPS receivers and adjustment software is capable of working in any worldwide ellipsoid or datum.

d. Connections to existing control. A variety of methods are available for making accurate connections and adjustments to the NGRS, such as OPUS, Auto-GIPSY, and SCOUT, which are described in Chapter 10. For most static and kinematic GPS horizontal control work, at least two (and preferably three) existing control points should be connected for referencing and adjusting a new GPS survey (Table 8-2). For higher-order NGRS densification, Table 2 of FGCC 1988 contains additional network connection criteria. Programs such as OPUS will adjust observations to three nearby NGRS/CORS stations. Existing points may be part of the NGRS (e.g., CORS stations) or in-place project control that has been adequately used for years. Additional points may be connected if practical. In some instances, a single existing point may be used to generate spurred baseline vectors for supplemental

construction control. For higher-order work, Table 8-2 recommends a baseline check connection between existing control points. This would not apply to NGRS CORS stations.

(1) Connections with local project control. The first choice for referencing new GPS surveys is the existing project control. This is true for most surveying, not just GPS, and has considerable legal basis. Unless a newly authorized project is involved, long-established project control reference points should be used, or at a minimum, connected with the overall scheme. If the project is currently on a local datum, then a supplemental tie to the NGRS should be considered as part of the project.

(2) Connections with NGRS. Connections with the NGRS are preferred where prudent and practical. As with conventional USACE surveying, such connections to the NGRS are not mandatory. In many instances, accurate connections with the NGRS CORS points may be easily (and economically) performed using NGS OPUS software methods--see Chapter 10. When existing project control is known to be of poor accuracy, then ties (and total readjustment) to the NGRS may be warranted. Sufficient project funds should have been programmed to cover the additional costs of these connections, including data submittal and review efforts if such work is intended to be included in the NGRS.

(3) Mixed NGRS and project control connections. On existing projects, NGRS-referenced points should not be arbitrarily mixed with existing project control. This is especially important if existing project control was poorly connected with the older NAD 27 control, or if the method of this original connection is uncertain. Since NGRS control has been readjusted to NAD 83 (including subsequent high-precision HARNs readjustments of NAD 83), and most USACE project control has not, problems may result if these schemes are mixed indiscriminately. If a decision is made to establish and/or update control on an existing project, and connections with the NGRS (NAD 83 (xxxx)) are required, then all existing project control points must be resurveyed and readjusted. Mixing different reference systems can result in different reference datums, with obvious adverse impacts on subsequent construction or boundary reference. It is far preferable to use "weak" existing (long-established) project control (on NAD 27 or whatever datum) for reference than to end up with a mixture of different systems or datums. See EM 1110-1-1004 for further discussion.

(4) Accuracy of connected reference control. Ideally, connections should be made to control of a higher order of accuracy than that intended for the project. In cases where NGRS/CORS control is readily available, this is usually the case. However, when only existing project control is available, connection and adjustment will have to be performed using that reference system, regardless of its accuracy. GPS baseline measurements should be performed over existing control to assess its accuracy and adequacy for adjustment, or to configure partially constrained adjustments.

(5) Connection constraints. Although Table 8-2 requires only a minimum of two existing stations to reliably connect GPS static and kinematic surveys, it may often be prudent to include additional NGRS and/or project points, especially if the existing network is of poor reliability. Adding more NGRS points provides redundant checks on the surrounding network. This allows for the elimination of these points should the final constrained adjustment indicate a problem with one or more of the fixed points. Use of NGS OPUS adjustment techniques allows DGPS connection and adjustment with multiple high-accuracy CORS stations, with positional accuracies within the 2 cm level. Table 8-2 also indicates the maximum allowable distance GPS baselines should extend from the existing network. FGCC 1988 standards also require connections to be spread over different quadrants relative to the survey project. This is recommended if possible; however, such requirements are usually unnecessary for most USACE work.

e. Multiple/Repeat/Independent baseline connections. FGCC 1988 lists recommended criteria for baseline connections between stations, repeat baseline observations, and multiple station occupations. Many of these standards were developed by NGS for performing high-precision geodetic control surveys

such that extensive redundancy will result from the collected data. Since the purpose of these geodetic densification surveys is markedly different from USACE control densification, the need for such high observational redundancy is also different. Therefore, Table 8-2 recommends not less than two repeat baseline occupations in a project--or at least 10% of the baselines in a project be double observed--whichever is less. Adding redundant baseline occupations may prove prudent on some remote projects where accessibility is difficult. In addition, observing the same baselines at different times and satellite configurations provides a good quality control check. When vertical control densification is performed, then all baselines shall be observed at least twice.

f. Independent baselines. When 3 or more receivers simultaneously occupy stations on a network, baselines can be formed from each pair of receivers. However, not all of these baselines are independent or "nontrivial." The "dependent" baselines are considered as "trivial" since they do not provide a unique solution. For example, if 4 receivers are deployed, 6 baselines are formed by these receivers. Only 3 of these lines are "independent"--the other 3 are "trivial" or dependent. The number of total baselines and independent baselines can be computed from the following:

$$\text{Number of Baselines per Session} = N(N - 1) / 2$$

$$\text{Number of Independent Baselines per Session} = N - 1$$

where N = number of receivers deployed on network. If only 2 receivers are used, then all the baselines will be independent. If 4 receivers are used over 10 sessions, then 30 independent baseline sessions would result. During the baseline processing and adjustment phase, the surveyor must identify the independent baselines when trivial observations are present, and ensure the adjustment statistics do not double count (or erroneously over weight) trivial baselines.

g. Loop requirements. Loops (i.e. traverses) made from GPS baseline observations provide the mechanism for performing field data validation as well as a final adjustment accuracy analysis. Since loops of GPS baselines are comparable to terrestrial EDM traverse routes, misclosures and adjustments can be handled similarly. Most GPS survey nets (static or kinematic) end up with one or more interconnecting loops that are either internal from a single fixed point or external through two or more fixed network points. Loops should be closed off within the maximum number of station intervals indicated in Table 8-2. Loop closures should meet the criteria specified in Table 8-2, based on the total loop length that should also be kept within the maximum lengths shown in Table 8-2. Loops must not include trivial baselines.

(1) GPS control surveys should be conducted by forming loops between two or more existing network control points, with adequate cross-connections within the loops where feasible. Such alignment procedures are usually most practical on civil works navigation projects, which typically require control to be established along a linear path, e.g., river or canal embankments, levees, beach renourishment projects, and jetties. Connections to existing control should be made as opportunities exist and/or as often as practical.

(2) When establishing control over relatively large military installations, civil recreation projects, flood control projects, and the like, a series of redundant baselines forming interconnecting loops is usually recommended. When densifying Second- and Third-Order control for site plan design and construction, extensive cross-connecting loop and network configurations recommended by the FGCC 1988 for geodetic surveying are not necessary.

(3) On all projects, maximum use of combined static and kinematic GPS observations should be considered, both of which may be configured to form pseudo-traverse loops for subsequent field data validation and final adjustment.

8-8. Recommended Static Baseline Occupation Times for Horizontal Control Surveys

Station occupation time is dependent on baseline length, number of satellites observed, GDOP, and the GPS equipment used. Occupation must be long enough to reliably fix the integer ambiguity in the baseline solution; thus, the more satellites in view the more reliable and faster the integers can be fixed. In general, a 20-minute to 2-hour occupation is required for lines less than 50 km. A rough guideline for estimating static baseline occupation time is shown in Table 8-3 below. From a statistical perspective, lengthier occupation times may not necessarily improve the accuracy once the integers have been reliably fixed. Reobserving the baseline on a different day/time (i.e. over a different satellite configuration) will provide better redundancy.

Table 8-3. Guidelines for Determining Static Baseline Occupation Time versus Satellite Visibility and Baseline Length--Single- and Dual-Frequency Horizontal GPS Control Surveys

Baseline Length (km)	Recommended Minimum Observation Time (minutes) Satellites in View/Single- or Dual-Frequency Receiver					
	4		5		6 or more satellites in view	
	Single	Dual	Single	Dual	Single	Dual
1-10 km	60 min	20 min	36 min	12 min	24 min	8 min
10-20 km	75 min	25 min	45 min	15 min	30 min	10 min
20-50 km ¹	105 min	35 min	75 min	25 min	60 min	20 min
> 50 ¹	180 min	60 min	135 min	45 min	90 min	30 min

¹ Dual-frequency receivers are recommended for baselines greater than 20 km
Source: USACE GPS Field Review Group (September 2002)

Some software vendors recommend shorter observation times when conditions are ideal (i.e. clear, unobstructed horizons, good quality measurements, dual-frequency geodetic quality receivers, and good geometry). For example, Waypoint Consulting recommends the following "rule-of-thumb" for determining the observation time on a baseline:

$$\text{Baseline Observation Time} = 10 \text{ minutes} + 1 \text{ minute/km (Single frequency)}$$

$$\text{Baseline Observation Time} = 5 \text{ minutes} + 0.5 \text{ minute/km (Dual frequency)}$$

The above guideline presumes expected horizontal accuracies of 10 mm, clear visibility, and clean data. Thus for a 40 km line, a dual-frequency minimum observation time would be 25 minutes. Alternatively, when precise vertical control is being densified using GPS, then session lengths may need to be increased--including observation of redundant baselines on different days.

a. Caveats. Due to the multitude of variables inherent in GPS surveying, there is no exact formula for determining the required baseline occupation time. The values shown in Table 8-3 are only general guidelines. The results from the baseline reduction (and subsequent adjustments) will govern the adequacy of the observation irrespective of the actual observation time. The most prudent policy is to exceed the minimum recommended times, especially for lines where reoccupation would be difficult or field data assessment capabilities are limited. Local conditions, manufacturer recommendations, and personal experience with specific receiver capabilities and baseline reduction results should also be factored into baseline occupation time requirements.

b. Dual-frequency receivers. For baselines greater than 10 km in length, the ionosphere usually has an adverse effect on the solution. Adverse ionosphere effects for baselines of this length can be reduced by using a dual-frequency GPS receiver, resulting in a more accurate ionospheric-free fixed solution than the less accurate float solution that might result from a single-frequency receiver. Accordingly, Table 8-3 recommends that dual-frequency receivers be used for baselines over 20 km in length. This is because fixed solution integers become more difficult to solve as the baselines lengthen. The dual-frequency receiver also provides "wide laning," which is a combination of the L1 and L2 frequencies. Wide laning is used to search and resolve the integer ambiguities.

8-9. Network Design and Layout for Carrier Phase GPS Horizontal Control Surveys

A wide variety of survey configuration methods may be used to densify project control using static and/or kinematic GPS survey techniques. Unlike terrestrial triangulation, trilateration, and EDM traverse surveying, the shape, or geometry, of the GPS network design is usually not as significant. The following guidelines for planning and designing proposed GPS surveys are intended to support lower order (Second-Order, Class I, or 1:50,000 or less accuracy) control surveys applicable to USACE civil works and military construction activities. An exception to this would be GPS surveys supporting structural deformation monitoring projects where relative accuracies at the centimeter level or better are required over a small project area.

a. NGRS connections. Newly established GPS control may or may not be incorporated into the NGRS, depending on the adequacy of connection to the existing NGRS network, or whether it was tied only internally to existing project control.

b. Project accuracy requirements. Of paramount importance in developing a network design is to obtain the most economical coverage within the prescribed project accuracy requirements. The optimum network design, therefore, provides a minimum amount of baseline/loop redundancy without an unnecessary amount of "over-observation." Obtaining this optimum design (cost versus accuracy) is difficult and constantly changing due to evolving GPS technology and satellite coverage.

c. GPS survey network schemes. Planning a GPS survey network scheme is similar to that for conventional triangulation or traversing. The type of survey design adopted is dependent on the GPS technique employed and the requirements of the user. A GPS network is developed to extend project control over an area. The network design establishes the stations to be occupied (new and existing) and specific baselines to be observed. The network design also includes the GPS observing sequence with a given number of GPS receivers. In addition, the network design should be geometrically sound and meet the criteria in Table 8-2. Triangles that are weak geometrically should be avoided, if possible. For lower-order work, elaborate network design schemes are unnecessary and less work-intensive GPS survey extension methods may be used. Care must be taken to avoid including trivial baselines in the final network adjustment. For high-accuracy vertical densification projects, duplicate or redundant baseline occupations may be required. The following figures depict examples of step-by-step methods to build a

GPS survey network, with a given number of receivers. Other combinations of observing sessions could be developed to accomplish the same results. The network consists of three fixed (known X-Y-Z) control points shown by circled triangles. The three unknown points are shown by triangles. Solid connecting lines are observed baselines in a session. Baselines marked by "t" are trivial baselines that should be excluded in any network adjustment.

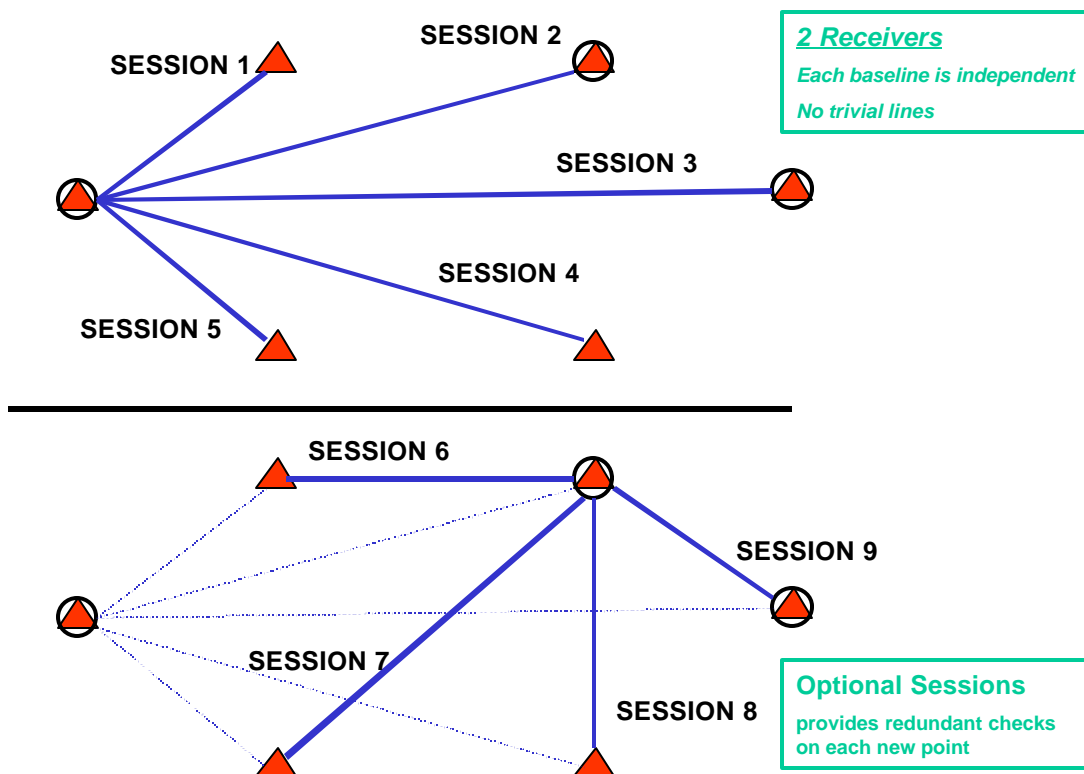

Figure 8-6. GPS observing sessions for 2 GPS receivers. If a check on the spurred positions is required, then sessions 6 through 9 could be optionally added.

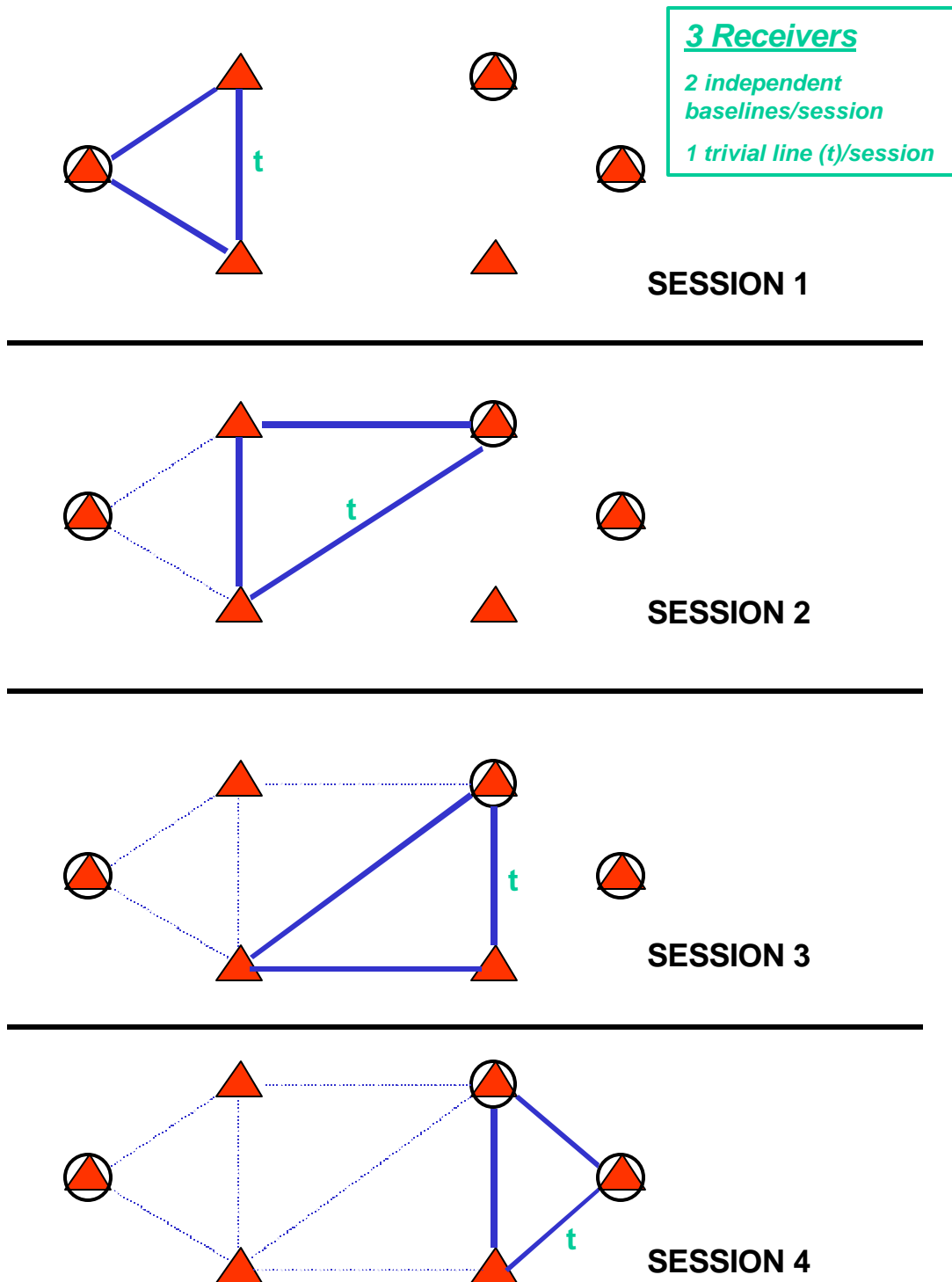

Figure 8-7. GPS network and observing session design given 3 GPS receivers

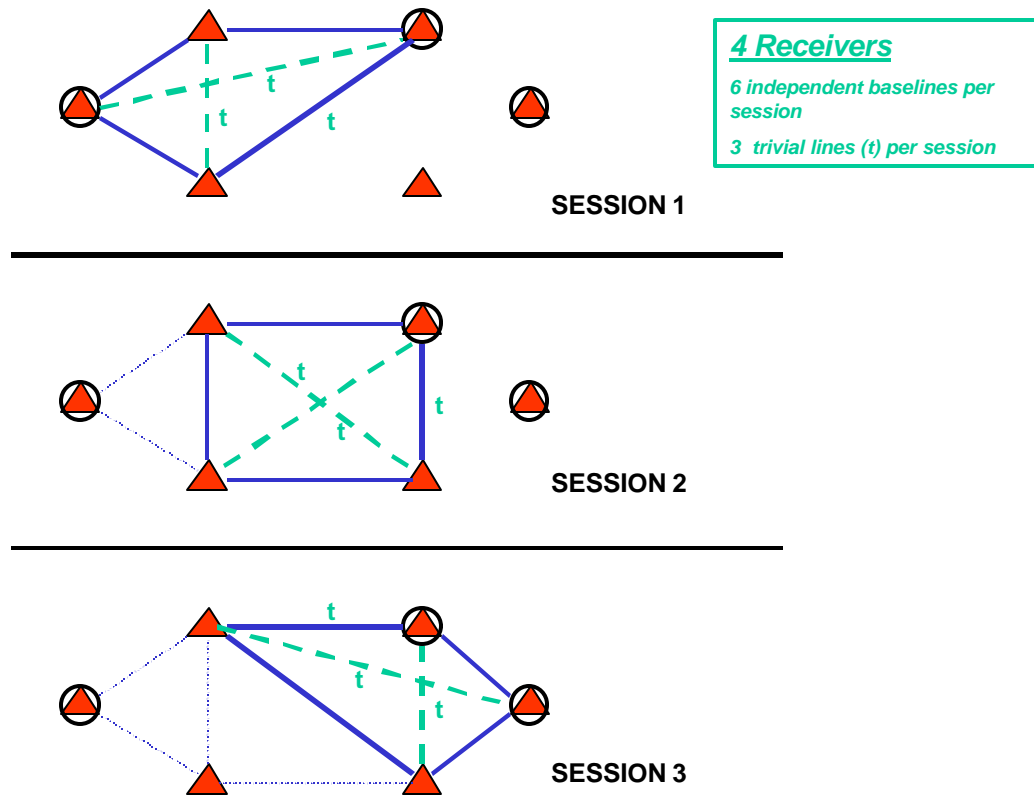

Figure 8-8. GPS network and observing session design given 4 GPS receivers

d. *GPS Traversing.* Traversing is the method of choice when the user has only two or three receivers and required accuracies are 1:5,000-1:50,000. Traversing with GPS is done similar to conventional methods. Open-end traverses are not recommended when 1:5,000 accuracies or greater are required. A minimum of one fixed (or known) control point is required, although two or more are preferred for redundancy. These points may or may not be part of the NGRS, or they may be existing Corps project control monuments. A closed loop traverse between two points is always preferred, as shown in Figure 8-9. When performing a loop traverse to/from a single point (open traverse or loop traverse), the surveyor should observe a check angle or check azimuth at the known point using conventional survey techniques to determine if the station has been disturbed.

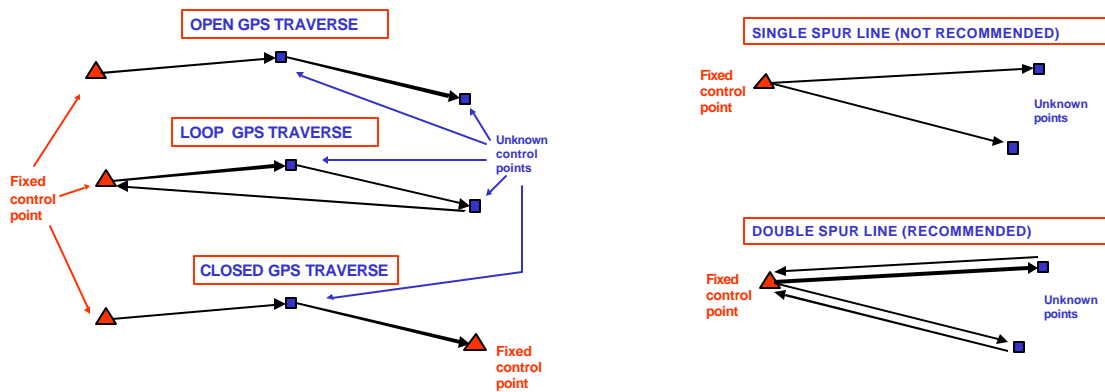

Figure 8-9. GPS traversing and spur line observation schemes

e. *GPS spur shots.* Spurs (or radial observations) are an acceptable method when the user has only two receivers or only a few lower-order project control points are to be established. Spur baselines should be observed twice during two independent observing sessions. Once the first session is completed, the receivers at each station must be turned off and the tripods moved and replumbed. Preferably, the second session should be observed during a different phase of the satellite constellation. This procedure is similar to performing a forward and backward level line. If this step is not implemented, the two baselines cannot be considered independent. Figure 8-9 above shows an example of a double observation over a spur line. The single spur shots shown in Figure 8-9 are not recommended for primary control; however, they are acceptable for standard site plan topographic and feature mapping typically performed with total station or RTK GPS methods.

8-10. Planning Vertical Control Surveys using Carrier Phase GPS

GPS can be used to extend and densify precise vertical control on USACE civil and military projects. This GPS application requires far more exacting measurement procedures than that required for horizontal control densification. This is due to: (1) GPS is less accurate in the vertical axis, (2) local geoid undulations must be accounted for, (3) the variety of vertical datum definitions and local readjustments, and (4) vertical orthometric datums can exhibit significant short-term local variations due to settlement. Accordingly, planning considerations for vertical control surveys are more critical than those required for horizontal surveys.

a. GPS positioning, whether operated in an absolute or differential positioning mode, can provide heights (or height differences) of surveyed points. As outlined in Chapter 3, the height " h " or height difference " Dh " obtained from GPS is in terms of height above or below the WGS 84 ellipsoid. These ellipsoid heights are not the same as orthometric heights, or elevations, which would be obtained from conventional differential/spirit leveling. This distinction between ellipsoid heights and orthometric elevations is critical to USACE engineering and construction projects; thus, users of GPS must exercise extreme care and caution in applying GPS height determinations to projects that are based on conventional orthometric elevations.

b. GPS uses WGS 84 as the optimal mathematical model best describing the shape of the true earth at sea level based on an ellipsoid of revolution. The WGS 84 ellipsoid adheres very well to the shape of the earth in terms of horizontal coordinates, but differs somewhat with the established definition(s) of orthometric height. The difference between ellipsoidal height, as measured by GPS, and conventional leveled (orthometric) heights is required over an entire project area to adjust GPS heights to orthometric elevations. In planning a vertical control project, appropriate geoid modeling software must be used to convert ellipsoidal heights to approximate orthometric elevations. These approximate geoid model conversions have improved with each release by NGS but should also be used with care and caution. In practice, conventional spirit leveling is performed as a quality control process for these geoidal adjustments.

c. Static or kinematic GPS survey techniques can be used effectively on a regional basis for the densification of lower accuracy vertical control for mapping purposes. Existing benchmark data (orthometric heights) and corresponding GPS-derived ellipsoidal values for at least three stations in a small project area can be used in tandem in a minimally constrained adjustment program to reasonably model the geoid in the local project area. More than three correlated stations are required for larger areas to ensure proper modeling of the geoidal undulations in the area. The model from the benchmark data and corresponding GPS data can then be used to derive the unknown orthometric heights of the remaining stations occupied during the GPS observation period.

d. Step-by-step vertical control planning, observation, and adjustment procedures employed by the NGS are described in the following sections and in some of the publications listed in Appendix A. These procedures are recommended should a USACE field activity utilize GPS to densify vertical control relative to an orthometric datum.

e. The criteria in the following sections do not apply to RTK topographic mapping surveys performed over a relatively small distance (say 500 to 1,000 m) from an existing benchmark. Over these short distances, geoid undulations are usually insignificant and observed ellipsoidal elevation differences can be assumed as orthometric. This is not the case when RTK surveys are extended beyond these distances, such as those typically encountered in determining elevations of dredge dragarms, core drilling rigs, or hydrographic survey platforms in distant, offshore navigation projects. For these applications, geoid modeling must be determined and applied.

8-11. Technical Criteria for GPS Vertical Densification

The following sections provide technical guidance for using differential carrier-phase GPS observations to determine elevations of survey benchmarks for wide-area mapping and GIS database development applications. Recommended procedural specifications for field DGPS observation sessions are included. These guidelines and specifications are intended for densifying vertical control over large project areas, such as an entire military installation or watershed basin mapping project. The DGPS methods outlined in this section are generally not intended, nor would be cost-effective, for small projects or any type of construction lay out work where vertical grades or benchmarks require an accuracy better than 30 millimeters (mm). In such cases, conventional differential (spirit) leveling methods should be used. Advances in geoid modeling have also led to more accurate conversions between NAD 83 GPS ellipsoid heights and NAVD 88 orthometric height systems. Accuracies of 30 mm or better have been obtained when converting ellipsoid heights from GPS surveys, based on NAD 83 control, to NAVD 88 orthometric heights using the latest geoid model. The initial GPS survey data must be valid for the elevation transfer method to be effective.

8-12. Orthometric Elevation Guidelines

The following paragraphs present the basic criteria standards for using GPS to determine NAVD 88 elevations. These criteria are also summarized in Table 8-4. These operational requirements are based on field test results conducted by US Army Topographic Engineering Center (ERDC/TEC) and the National Geodetic Survey (NGS) using several different GPS surveying methods and comparing these results to conventional differential leveling networks. Additional standards and specifications for performing precise GPS vertical control surveys are contained in *Guidelines for Establishing GPS-Derived Ellipsoid Heights (Standards: 2 cm and 5 cm)* (NOAA 1997). Much of the guidance contained in this section is derived from the material in this reference. USACE commands performing vertical densification surveys with GPS should be thoroughly familiar with the contents of the NOAA 1997 reference.

Table 8-4. Guidelines for Establishing GPS-Derived \pm 30 mm Accuracy Orthometric Elevations

Occupation time for each baseline occupation (minimum):		
Distance	Time	Update rate
< 10 km	30 min	5 sec intervals
10-20 km	60 min	10 sec intervals
20-40 km	120 min	15 sec intervals
40-60 km	180 min	15 sec intervals
60-80 km	240 min	15 sec intervals
80-100 km	300 min	15 sec intervals
> 100 km	> 5 hours	15 sec intervals

Dual-frequency receiver required:	Yes
Geodetic quality antenna with ground plane required:	Yes
Minimum number of existing benchmarks required:	3
Minimum number of observations per baseline:	2
Fixed-height tripods/poles:	Recommended
Measure antenna height:	2 to 3 times
Satellite altitude mask angle:	15 degrees
Maximum allowable VDOP:	5
Number of days station occupied:	2 days
Over 40 km baselines:	3 days
Nominal distance between project and fixed, higher-order benchmarks:	within 20 km radius
Maximum distance between same or higher-order benchmarks:	50 km
Collect meteorological data:	Optional
Precise ephemeris baseline reduction required:	Yes
Recommended geoid model:	Geoid 99 (or most recent)
Fixed integers required for all baselines:	Yes
Baseline resultant RMS less than:	2.5

Source: Table 1 of (NOAA 1997) with USACE revisions

a. Baselines. GPS baselines are observed to determine ellipsoidal height differences across a network of stations. A GPS precise ephemeris should be used in place of the broadcast ephemeris during baseline data processing. Repeat baselines should be observed for all control surveys established with DGPS. The average ellipsoid height from the repeat observations will be closer to the truth, with a few exceptions, than the ellipsoid height value from a single observation. Table 8-4 recommends a minimum of two repeat observations for each baseline. Baselines should be reobserved on different days with significantly different satellite geometry. For topographic and location surveys (using kinematic techniques), repeat occupations should be performed where feasible. It is important that the positions be adjusted on NAD 83 since the most recent geoid models are also based on NAD 83.

b. NAVD 88 network connections. At least three or more established NAVD 88 First-Order benchmarks should be occupied to serve as the GPS reference stations where accurate vertical coordinates will be fixed for the network adjustment. It is suggested that at least one (preferably 2 or more) of these benchmarks are also High Precision Geodetic Network (HPGN), High Accuracy Reference Network (HARN), or CORS stations to ensure accurate geoid modeling. First-Order accuracy standards for geodetic leveling ensure the relative vertical position of these reference monuments will agree. Redundant vertical control within the project area will provide a check on the solution heights of the unknown stations. The ideal condition would be to have all benchmarks with high-order vertical and horizontal control surrounding and/or within the project area. Table 8-4 recommends the distance between existing reference benchmarks should be kept within 50 km. If this value is exceeded, then additional network connections should be added.

c. Geoid models. Geoid heights at the reference stations are determined from a published geoid model, GEOID 96 or GEOID 99. The geoid height is added to the published orthometric height at the GPS reference station to determine its ellipsoid height to the accuracy level of the geoid model. Once the reference stations' ellipsoidal, orthometric and geoidal heights have been fully determined, elevations are transferred from the reference stations to the remaining points in the network according to the following relations:

From Equation 3-1 back in Chapter 3,

$$H_i = h_i - N_i \quad (\text{where } i \text{ is the station of unknown height})$$

$$H_{ref} = h_{ref} - N_{ref}, \quad (\text{where } ref \text{ is the station of known heights})$$

with measured difference in ellipsoid height ($Dh = h_i - h_{ref}$) from a DGPS survey, and computed difference in geoid height ($DN = N_i - N_{ref}$) from a known geoid model, then,

$$H_i = H_{ref} + (H_i - H_{ref})$$

$$H_i = H_{ref} + (h_i - N_i) - (h_{ref} - N_{ref})$$

$$H_i = H_{ref} + (h_i - h_{ref}) - (N_i - N_{ref})$$

Then,

$$H_i = H_{ref} + (Dh - DN) \tag{Eq 8-1}$$

where in Equation 8-1 H_i is the orthometric height of the i -th station, the quantity Dh is determined from the measured GPS ellipsoidal height differences, and the quantity DN is the geoidal height difference computed from the geoid model. Over very small distances (< 1,000 m), DN may be considered negligible, and the ellipsoidal height difference Dh is added directly to the orthometric height of the

reference station to obtain the orthometric height of the unknown point. This practice is commonly employed for GPS RTK topographic site plan or construction surveys over small areas.

d. Elevation precision and accuracy. The expected precision of the orthometric height from using GPS relative positioning, modeled geoid heights, and the above relation in Equation 8-1 can be calculated by the summation of variance components corresponding to the accuracy of the published orthometric height, the GPS relative height determination, and the computed geoid height differences. Positional accuracy for orthometric heights on benchmarks must be obtained from published sources based on the results of a vertical network adjustment. Without this information it is presumed that a fixed vertical control point contributes no additional error to the height of the unknown stations. The uncertainties in GPS relative heights are estimated from the vertical component error estimate that is produced from the GPS data processing and adjustment software. An error estimate of ± 10 mm is commonly seen as the minimum baseline error produced from static type surveys. Relative geoidal height precision ($\sigma_{\Delta N}$) from geoid modeling can have an expected standard deviation of between ± 10 mm and ± 20 mm.

e. Elevation confidence. The aforementioned error values lead to an expected uncertainty in final orthometric height at the unknown station of approximately 3 cm (at the 95% confidence level) relative to the published elevation at the benchmark reference station. NOAA 1997 specifies procedures for two potential levels of accuracy: ± 20 mm and ± 50 mm. NOAA procedures for " ± 2 cm (20 mm)" ellipsoid elevation accuracy should be followed if approximately ± 30 mm accuracy reduced orthometric elevations are desired. A repeatable accuracy of ± 30 mm meets or exceeds most feature elevation tolerances specified for many USACE surveying and mapping projects, excepting certain high precision surveys such as for low flow hydraulic studies, construction stake out, or structural deformation monitoring networks. In areas with obstructions, dense vegetation, or high relief between monuments or projects site, GPS may be the most cost effective approach and may exceed spirit leveling accuracy. In some cases, GPS elevation difference observations can be obtained more quickly than conventional differential leveling observations.

f. Field testing results. Based on an evaluation of DGPS data and geoid modeling software capabilities by ERDC/TEC, it was determined that higher accuracy elevations are obtained by the transfer of ellipsoidal height differences and relative geoidal heights from a station with a known NAVD 88 elevation, than is possible from the direct application of absolute geoid heights to GPS networks. This analysis was based on various methods used for determining NAVD 88 elevations from GPS ellipsoidal height data. These methods were tested on a network of points having known First-Order leveled orthometric heights that were tied to First-Order vertical control. Results of the testing indicated that GPS-based surveys could determine NAVD 88 elevations to an accuracy of ± 30 mm when relative heights and differences in geoid heights are applied. It is important to note that the accuracy of NAVD 88 elevations determined from DGPS-derived heights and geoid modeling is dependent on the accuracy of the GPS coordinate solution and the geoid model.

8-13. Additional Guidelines and Recommendations for Planning GPS Vertical Densification

In addition to the guidelines presented in the above section, the following procedures and methods are recommended and should be implemented when planning to use GPS for elevation determination.

a. Keep project areas within a 20-kilometer radius of control points. GPS relative positioning accuracy depends in part on the length of the measured baseline. Positioning errors grow in direct proportion to baseline length at a rate of approximately 1 part per million. For networks with an area less

than 20 km, the distance dependent error in the GPS vertical component (relative ellipsoid height) will be limited. Occupation times of less than 1 hour (see Table 8-4) should produce good results for these shorter baselines. For project areas greater than 20 km, the occupation times should be increased to a minimum of 2 hours. Fixed control points should be spaced throughout (surrounding and within) the project area.

b. Observe when VDOP is less than 5.0. Vertical Dilution of Precision (VDOP) is a measure of vertical positioning accuracy (due mainly to satellite geometry) relative to the precision of the measurements used to determine the position. Large VDOP values represent poor satellite geometry that will generally produce weak positioning solutions.

c. Use fixed-height tripods/poles. Fixed-height tripods and range poles provide a consistent station occupation method that can reduce the likelihood of antenna height measurement blunders.

d. Use dual-frequency receivers. Dual-frequency receivers can correct GPS measurements for ionospheric-based range errors. This will extend the feasible baseline length and resolve integer ambiguities reliably within 20 km. Dual-frequency receivers should be used on all baselines longer than 20 km.

e. Use identical geodetic quality antennas with ground plane. Different makes and models of GPS antennas can have different phase centers. Mixing of different types of antennas can cause errors in the vertical component up to 100 mm. Only if the processing software can account for the phase center difference in the GPS antennas should mixing of antenna types occur. The ground plane on the antenna (or choke ring antenna design) will reduce the amount of ground reflecting multipath.

f. Occupy points a minimum of twice with different satellite constellations and on different days. The purpose of this criteria is to ensure different atmospheric conditions (different days) and significantly different satellite geometry (different times) for the two occupations. For example, if the first day's observation was made between 8:00 AM to 8:30 AM, the second 30-minute observation would be made on the next day anytime between 11:30 AM and 5:30 PM. If the second observation is not made for a couple of days or even a week, be sure to compensate for the daily 4-minute accumulative change in the GPS satellite constellation. It has been shown that the average ellipsoid height of repeat observations is closer to the truth, with a few exceptions, than the ellipsoid height of a single observation.

g. Process with a minimum elevation mask of 15 degrees. A 15-degree elevation mask will reduce noise embedded in low elevation satellite data and also minimize potential multipath effects from nearby objects surrounding the antenna. For obstructions low on the horizon, a 20-degree elevation mask may be used during baseline processing.

h. Process GPS data with Precise Ephemeris. The broadcast ephemeris is the prediction of where the satellites will be, but the precise ephemeris is the actual true orbit of the satellites. Use of a precise ephemeris will reduce the error between predicted and actual satellite orbit and increase the accuracy of the survey. The precise ephemeris is available approximately seven days after a survey through the National Geodetic Survey.

i. Use only ionosphere free fixed baseline solutions for baselines greater than 10 k. Ionosphere-free solutions indicate the use of dual-frequency receivers and processing can model and eliminate errors due to signal delay in the ionosphere. Fixed baseline solutions indicate a statistically accurate integer ambiguity was established from the GPS data. A normal, (not ionosphere-free) fixed baseline is sufficient for baselines less than 10 km.

j. Use relative geoid height values. Application of the geoid model to both reference and remote stations will produce two absolute geoid heights. The relative geoid height value is determined from the difference between the absolute geoid model height values taken at both ends of a given baseline. Relative geoid heights, when added to measured ellipsoidal height differences, produces the best vertical accuracy based on the ground truth test results.

k. Adjustments. A minimally constrained least-squares adjustment should be performed on the vertical reference network to determine which of the "fixed" benchmarks are valid. Such a free adjustment would hold one of the benchmarks fixed in X, Y, and Z in order to check the fit against the other established benchmarks. Presuming no observational blunders, any benchmark with apparent excessive movement would be discarded from the final (constrained) adjustment.

l. Geoid models. Different geoid models should not be mixed in the same project. Different geoid models can vary by 5 cm or more. For example, if a project network was originally adjusted using GEOID 93, do not mix in GEOID 96 or GEOID 99 with subsequent observations--unless the entire project is readjusted using a later geoid model. GEOID 96 (or a more recent update) is recommended for projects on NAVD 88 datum.

8-14. Cadastral Survey Standards and Guidelines using GPS

The Bureau of Land Management and the US Forest Service jointly developed GPS survey standards for surveys of the public lands of the US-- *Standards and Guidelines for Cadastral Surveys using Global Positioning System Methods* (USFS/BLM 2001). These standards and guidelines may prove useful when Corps commands are required to connect military installation boundaries or reservoir boundaries with the US Public Land Survey System (PLSS). Both static and kinematic survey techniques are covered in the guidelines. They also cover field data acquisition methods, field survey operation and procedures, data processing and analysis methodologies, and required documentation. Two types of GPS control surveys are defined: (1) Cadastral Project Control, and (2) Cadastral Measurements.

a. Cadastral Project Control includes monuments established by direct connection with the primary NGRS (HARN/HPGN/CORS) network. These monuments serve as the basis for all subsequent connections by GPS Cadastral Measurements made to PLSS monuments. Cadastral Project Control must be connected with at least two NGRS points. The reference datum shall be the latest epoch of NAD 1983 (1986)--e.g., Wyoming NAD 1983 (1993). Only Static or Fast-Static survey methods are allowed for these connections. Points must be established by two or more independent baselines, loops must have a minimum of three baselines, baseline solutions must be fixed double difference, and all stations must have at least two independent occupations. Single radial (spur) baselines are not allowed.

b. Cadastral Measurements are used to define the location of PLSS corners and boundaries. Cadastral Measurements must be connected with at least two Cadastral Project Control monuments or NGRS monuments. Guidelines for these observations are similar to those required for Cadastral Project Control, except all types of static and kinematic survey methods are acceptable, including real-time kinematic (RTK) techniques. The USFS/BLM guidelines contain extensive procedural and calibration requirements for RTK surveys.

c. Positional accuracy standards for USFS/BLM cadastral surveys are defined relative to the 95% confidence level, as outlined in Table 8-5 below.

Table 8-5. USFS/BLM Cadastral Survey Standards for Positional Accuracy

	Definition	95 % Confidence Level	
		Cadastral Project Control	Cadastral Measurements
Local Accuracy	Average measure of the relative accuracies of the coordinates for a point with respect to other adjacent points	0.050 m	0.100 m
Network Accuracy	Relative to the NGRS network	0.100 m	0.200 m

The 95% positional accuracy of established points is assessed from the output of the network adjustment, as explained in Chapter 11.

8-15. Field Planning Considerations for GPS Surveys

After a GPS horizontal and/or vertical densification network has been designed, specified, and laid out, the logistics of performing the GPS field survey needs to be considered. The most efficient survey method should be chosen in order to minimize time and cost while meeting the accuracy requirements of a given survey project. Once a survey technique is developed, equipment requirements, personnel assignments, observation schedules, and session designations can be identified.

a. General equipment requirements. The type of GPS instrumentation required for a survey depends on the accuracy requirements of the project, GPS survey technique, project size, and economics. Most USACE projects can be completed using a single-frequency receiver. Dual-frequency receivers are recommended as baseline lengths approach or exceed 20 km. This length may also vary depending on the amount of solar activity during the observation period. Using a dual-frequency receiver permits the user to solve for possible ionospheric and troposphere delays, which can occur as the signal travels from the satellite to the receiver antenna.

(1) Number of GPS receivers. The minimum number of receivers required to perform a differential GPS survey is two. The actual number used on a project will depend on the project size and number of available instruments/operators. Using more than two receivers will often increase productivity and allow for more efficient field observations. For some post-processed kinematic applications, two reference receivers (set at known points) and at least one rover are recommended.

(2) Personnel. Personnel requirements are also project dependent. Most GPS equipment is compact and lightweight and only requires one person per station set-up. However, in some cases where a station is not easily accessible or requires additional power for a data link, two individuals may be required.

(3) Transportation. One vehicle is normally required for each GPS receiver used on a project. If secure sites are available, GPS receivers may be left unattended. The survey vehicle should be equipped to handle the physical conditions that may be encountered while performing the field observations. In most cases, a two-wheel-drive vehicle should be adequate for performing all field observations. If adverse site conditions exist, a four-wheel-drive vehicle may be required. Adequate and reliable transportation is important when the observation schedule requires moving from one station to another between observation sessions.

(4) Auxiliary equipment. Adequate power should be available for all equipment (receivers, computers, lights, etc.) that will be used during the observations. Computers, software, and data storage/archiving devices should be available for on-site field data reduction use. Other survey equipment should include tripods, tribrachs, tribrach adapters, radios, cell phones, measuring tapes, flagging, flashlights, tools, equipment cables, compass, psychrometer, inclinometer, etc. If real-time positioning is required, than a data link is also needed.

(5) Benchmarks. Special equipment is required to set deep-driven permanent benchmarks, as illustrated in Figure 8-10.



Figure 8-10. Setting deep-driven benchmarks (Memphis District & 3001, Inc.)

b. Observation schedules. Planning a GPS survey requires that the surveyor determine when satellites will be visible for the given survey area; therefore, the first step in determining observation schedules is to plot a satellite visibility plot for days GPS observations are planned. If some sectors are obstructed, at least 4 satellites may not be visible at all times. At least 5 satellites are required for RTK OTF initialization.

(1) Most GPS manufacturers have software packages that predict satellite rise and set times. Satellite predictions are also available on various web sites. A satellite plot will have the following essential information: satellite azimuths, elevations, set and rise times, and PDOP for the desired survey area. A typical visibility plot is shown at Figure 8-11. Satellite ephemeris data are generally required as input for the prediction software.

(2) To obtain broadcast ephemeris information, a GPS receiver collects data during a satellite window. The receiver antenna does not have to be located over a known point when collecting a broadcast ephemeris. The data is then downloaded to a personal computer where it is used as input into the software prediction program. Besides ephemeris data for the software, the user is generally required to enter approximate latitude and longitude (usually scaled from a topographic map) and time offset from UTC for the survey area. A current ephemeris file can be downloaded using various manufacturer's planning software.

(3) From the satellite plot, the user can determine the best time to perform a successful GPS survey by taking advantage of the best combination of satellite azimuths, elevations, and PDOP as determined by the satellite visibility plot for the desired survey area. The number of sessions and/or stations per day depends on satellite visibility, travel times between stations, and the final accuracy of the survey. Often, a receiver is required to occupy a station for more than one session per day.

(4) A satellite visibility plot and a PDOP versus time plot may be run prior to site reconnaissance. The output files created by the satellite prediction software are used in determining if a site is suitable for GPS surveying.

(5) Determination of session times is based mainly on the satellite visibility plan with the following factors taken into consideration: time required to permit safe travel between survey sites; time to set up and take down the equipment before and after the survey; time of survey; and possible time loss due to unforeseeable problems or complications. Station occupation during each session should be designed to minimize travel time in order to maximize the overall efficiency of the survey.

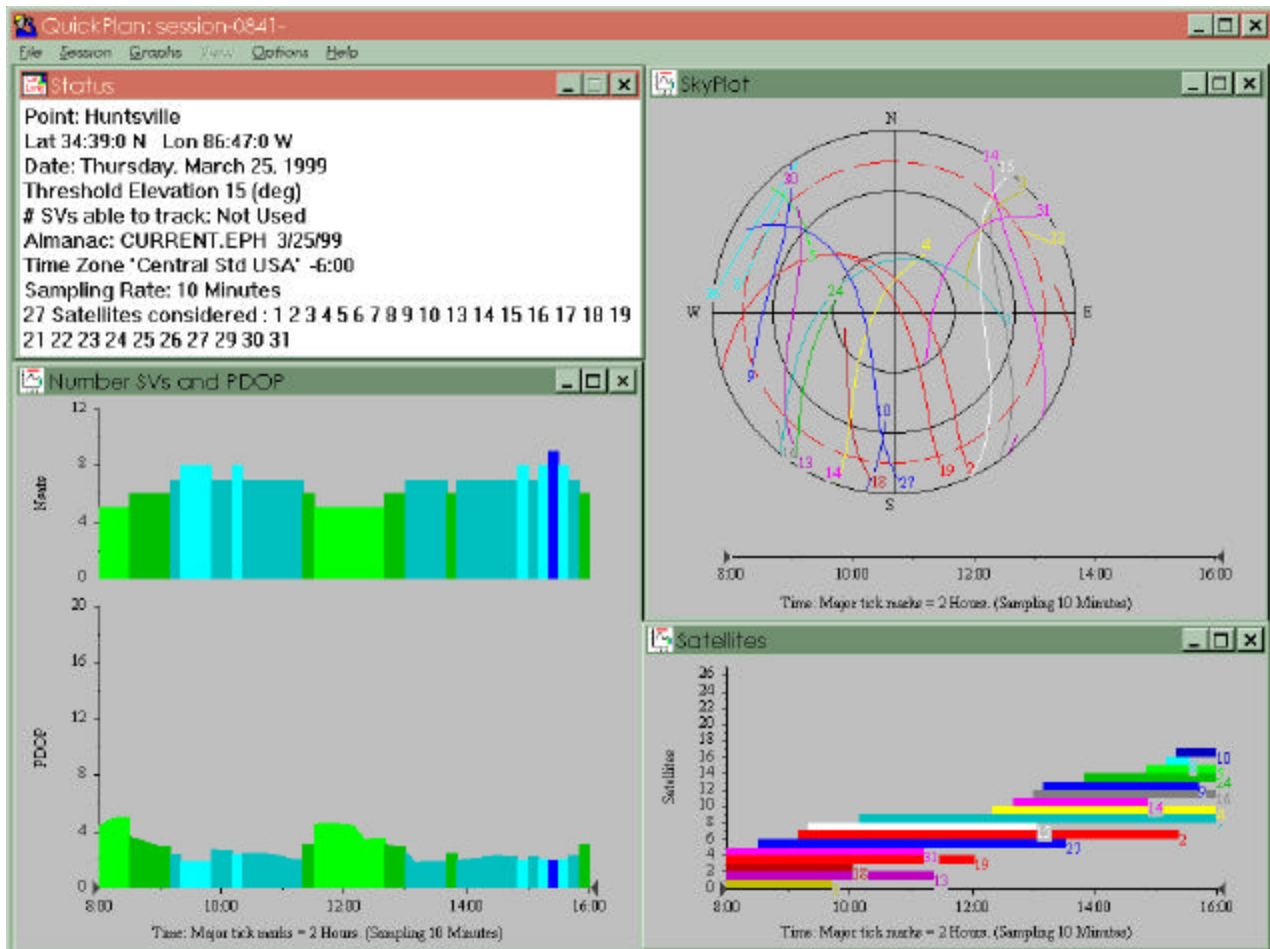

Figure 8-11. Visibility plot of satellites and PDOP versus Time

8-16. Mandatory Criteria

The guidelines in Table 8-2 and Table 8-4 shall be considered mandatory.

Chapter 9 Conducting GPS Field Surveys

9-1. General

This chapter presents guidance to field personnel performing GPS surveys for typical USACE military construction and civil works projects. The primary emphasis in this chapter is on performing static and kinematic carrier phase differential GPS measurements. Absolute and differential code phase GPS positioning and mapping techniques are also covered. Detailed field instructions for specific GPS receivers are typically contained in the operating or reference manuals provided by the manufacturer. Given the wide variety of GPS receivers, coupled with the different types of data collection, logging, processing, and adjustment techniques that can be performed in the field, this chapter can only provide a brief overview of some representative systems; and highlight observing criteria which is common to all types of GPS equipment.

9-2. General GPS Field Survey Procedures

The following are some general GPS field survey procedures that should be performed at each occupied point on a GPS survey. These general procedures apply to either static or kinematic observation methods, and to either real-time or post-processed data collection.

a. Receiver set up. GPS receivers shall be set up in accordance with manufacturer's specifications prior to beginning any observations. Base station antennas are typically mounted on a tripod and kinematic rover receivers and antenna are mounted on fixed-height range poles. If real-time kinematic observations are being collected, then radio or satellite communication links will need to be set up. Newer GPS systems contain a separate data controller to record, coordinate, and process all GPS data collection. Figure 9-1 depicts a typical data collector.

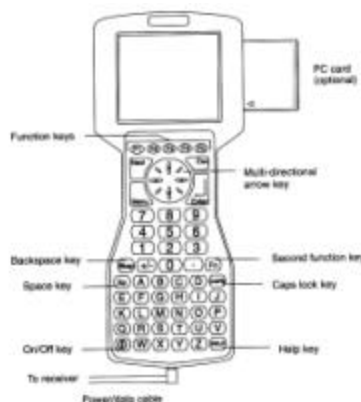

Figure 9-1. Typical GPS data collector used for static and real-time kinematic surveys (Trimble Survey Controller, Trimble Navigation LTD)

b. Antenna setup. All tribrachs used on a project should be calibrated and adjusted prior to beginning each project. Dual use of both optical plummets and standard plumb bobs is strongly recommended since centering errors represent a major error source in all survey work, not just GPS surveying. A reference line marked on the antenna should always be pointed or aligned in the same

direction (e.g., north), using a magnetic compass. Tripods should be checked daily for tightness and fixed-height tripods and range poles should be periodically calibrated.

c. Height of instrument measurements. Height of instrument (HI) refers to the correct measurement of the distance of the GPS antenna above the reference monument over which it has been placed. In actuality, the physical measurement is made to some fixed point on the antenna mounting device from which the previously calibrated distance to the antenna phase center (APC) can be added. This is shown for different types of fixed range pole mounts in Figure 9-2. HI measurements should be made both before and after each observation session. The standard reference points for each antenna will be established prior to the beginning of the observations so all observers will be measuring to the same point. All HI measurements will be made in both meters and feet for redundancy and blunder detection. HI measurements shall be determined to the nearest millimeter in metric units and to the nearest 0.01 ft (or 1/16 in.). It should be noted whether the HI is vertical or diagonal. Each GPS receiver/antenna manufacturer provides specific antenna height measuring guidance in their instrument operating manual. Figure 9-2 depicts some of the measurement methods required for different types of Trimble antennas. For some instruments (e.g., Trimble GPS Total Station 4800 and 4600LS Receiver) a special measuring tape and instructions is provided by the manufacturer--see lower right example in Figure 9-2. When a ground plane is used at a base receiver, direct distances are measured to different points on the antenna and the average of these distances is entered into the controller as a slope distance for automatic correction. The GPS survey controller will typically query input for the type of antenna and mount.

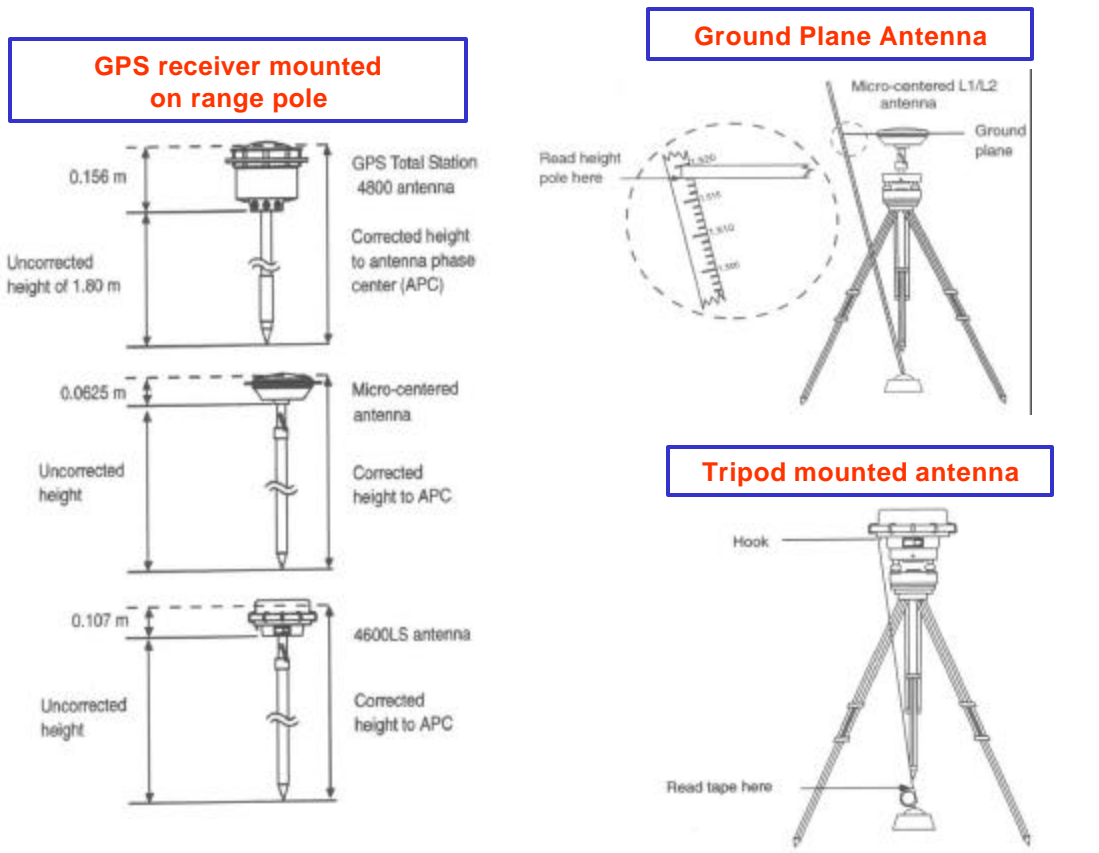

Figure 9-2. Antenna height measurements for various types of mounts and antenna types (Trimble Navigation LTD)

d. Field GPS observation recording procedures. Field recording books, log sheets, log forms, or full-text input data collectors will be completed for each station and/or session. Any acceptable recording media may be used. For archiving purposes, standard bound field survey books are preferred; however, USACE commands may specify written or automated logging media to be used in lieu of a survey book. The amount of record keeping detail will be project dependent; low-order topographic mapping points need not have as much descriptive information as would permanently marked primary control points. The following typical data may be included on these field logging records:

- (1) Project, construction contract, observer(s) name(s), and/or A-E or construction contractor firm and contract/task order number
- (2) Station designation
- (3) Station file number
- (4) Date, weather conditions, etc.
- (5) Time start/stop session (local and UTC)
- (6) Receiver, antenna, data recording unit, and tribrach make, model, and serial numbers
- (7) Antenna height: vertical or diagonal measures in inches (or feet) and meters (or centimeters)
- (8) Space vehicle (SV) designations of satellites observed during sessions
- (9) Sketch of station location
- (10) Approximate geodetic location and elevation
- (11) Problems encountered

USACE commands may require that additional data be recorded. These will be contained in individual project instructions or contract task order scopes. Samples of typical GPS recording forms are shown later in this section.

e. Field calibrations and initializations. When kinematic surveys are performed, it may be necessary to calibrate the base station to a known local coordinate point and reference datum. An initialization process may also be required for some types of kinematic surveys. Check with manufacturer's recommendations on specific techniques for calibrating RTK surveys to a local datum. These calibrations should be clearly noted on log records for the survey.

f. Field processing and verification. It is strongly recommended that GPS data processing and verification be performed in the field where applicable. This is to identify any problems that can be corrected before returning from the field. Survey processing and verification are covered in Chapters 10 and 11.

g. Session designations. A survey session in GPS terminology refers to a single period of observations. Sessions and station designations are usually denoted and input into the data collector using alphanumeric characters, following format restrictions allowed by the receiver vendor. The station and session designations should be clearly correlated with entries on the log forms so that there are no questions during subsequent baseline processing. The date of each survey session should be recorded

during the survey as calendar dates and Julian days and used in the station/session designation. Some GPS software programs will require Julian dates for correct software operation. In addition to determination of station/session designations before the survey begins, the crew chief may need to consider or review some of the following factors:

- Persons designated to occupy each station.
- Satellite visibility for each station.
- Site reconnaissance data for stations to be occupied. Remember the same person who performed the initial site reconnaissance may not be the individual performing the survey; therefore, previous site reconnaissance data may require clarification before survey commencement.
- Project sketch.
- Explicit instructions on when each session is to begin and end, and follow-up sessions.
- Providing observers with data logging sheets for each occupied station.

h. GPS Station Log forms. The following figures contain samples of station logs used by various USACE districts. Standard bound field survey books may be used in lieu of separate log/work sheets.

U.S. ARMY CORPS OF ENGINEERS GPS DATA LOGGING SHEET						

PROJECT NAME	<u>COYOTE DAM</u>		LOCALITY	<u>UKIAH, CA</u>		
OBSERVER	<u>LARRY LAMB</u>		AGENCY/FIRM	<u>COE, SACRAMENTO DIST.</u>		
RECEIVER	<u>TRIMBLE 4000 SL</u>		S/N	<u>2820A00223</u>		
ANTENNA	<u>TRIMBLE MICRO SL</u>		S/N	<u>2816A00224</u>		
DATA RECORDING UNIT	<u>RECEIVER</u>		S/N	<u>2820A00223</u>		
TRIBRACH	<u>WILD GDF22</u>		S/N	<u>N/A</u>		LAST CALIBRATED: <u>4/24/89</u>

	SESSION 1		SESSION 2		SESSION 3	
STATION NAME	<u>PIER 2</u>		<u>PIER 2</u>		<u>PIER 2</u>	
STATION NUMBER	<u>2002</u>		<u>2002</u>		<u>2002</u>	
DAY OF YEAR	<u>115</u>		<u>115</u>		<u>115</u>	
DATE MM DD YY	<u>04/25/89</u>		<u>04/25/89</u>		<u>04/25/89</u>	
UTC TIME OF OBSERVATION	START	STOP	START	STOP	START	STOP
	<u>04:56</u>	<u>05:55</u>	<u>06:10</u>	<u>07:38</u>	<u>07:55</u>	<u>09:20</u>

ANTENNA HEIGHT MEASUREMENTS						
	SESSION 1		SESSION 2		SESSION 3	
SLOPE @ BEGINNING	<u>0.120</u>	<u>0.120</u> <u>0.119</u>	<u>0.116</u>	<u>0.116</u> <u>0.116</u>	<u>0.123</u>	<u>0.124</u> <u>0.124</u>
	<u>4¹⁵/₁₆</u>	IN = <u>0.121</u> M	<u>4⁹/₁₆</u>	IN = <u>0.116</u> M	<u>4¹⁴/₁₆</u>	IN = <u>0.124</u> M
	MN = <u>0.120</u>	M	MN = <u>0.116</u>	M	MN = <u>0.1238</u>	M
SLOPE @ END	<u>4¹⁴/₁₆</u>	<u>4¹⁵/₁₆</u> <u>4¹⁴/₁₆</u>	<u>4⁹/₁₆</u>	<u>4⁹/₁₆</u> <u>4⁹/₁₆</u>	<u>4¹³/₁₆</u>	<u>4¹⁴/₁₆</u> <u>4¹⁴/₁₆</u>
	<u>0.120</u>	M = <u>4¹⁵/₁₆</u> IN	<u>0.116</u>	M = <u>4⁹/₁₆</u> IN	<u>0.123</u>	M = <u>4¹⁴/₁₆</u> IN
	MN = <u>0.120</u>	M	MN = <u>0.116</u>	M	MN = <u>0.1230</u>	M
MN ADJ TO VERT	<u>0.120</u> M		<u>0.116</u> M		<u>0.1234</u> M	

	PROGRAMMED REFPOS	FIELD POSITION	PROGRAMMED REFPOS	FIELD POSITION	PROGRAMMED REFPOS	FIELD POSITION
LAT	<u>39-12-30</u>	<u>39-12-22.64</u>	<u>39-12-30</u>	<u>39-12-22.48</u>	<u>39-12-30</u>	<u>39-12-22.81</u>
LONG	<u>123-10-30</u>	<u>123-10-33.42</u>	<u>123-10-30</u>	<u>123-10-33.20</u>	<u>123-10-30</u>	<u>123-10-33.62</u>
HT	<u>244.0</u>	<u>210.6</u>	<u>244.0</u>	<u>199.8</u>	<u>244.0</u>	<u>222.8</u>
PDOP	<u>3.6</u>		<u>4.8</u>		<u>4.0</u>	
SVS TO TRACK	<u>02, 03, 06, 09, 11, 12, 13, 14</u>		<u>02, 03, 06, 09, 11, 12, 13, 14</u>		<u>03, 06, 09, 11, 12, 13, 14, 16</u>	
LOCAL TIME:	SCHEDULED	ACTUAL	SCHEDULED	ACTUAL	SCHEDULED	ACTUAL
START	<u>21:55</u>	<u>21:56</u>	<u>23:38</u>	<u>23:10</u>	<u>01:20</u>	<u>00:55</u>
STOP	<u>22:55</u>	<u>22:55</u>	<u>00:38</u>	<u>00:38</u>	<u>02:20</u>	<u>02:20</u>

Figure 9-3. Sample USACE GPS data logging sheet

U.S. ARMY CORPS OF ENGINEERS GPS DATA LOGGING SHEET			
	SESSION 1	SESSION 2	SESSION 3
ANT CABLE LENGTH	<u>100 ft</u>	<u>100 ft</u>	<u>35 ft</u>
POWER SUPPLY	<u>12V DC</u>	<u>12V DC</u>	<u>12V DC</u>
WEATHER CONDITIONS	<u>CLEAR, COOL 45°</u>	<u>CLEAR, COOL 40°</u>	<u>CLEAR, BREEZY 40°</u>
MONUMENT TYPE	<u>'C' (SET IN PIER)</u>	<u>← SAME</u>	<u>SAME</u>
EXACT STAMPING	<u>PIER 2 1953</u>	<u>← "</u>	<u>"</u>
AGENCY CAST IN DISK	<u>COE</u>	<u>← "</u>	<u>"</u>

SESSION 1	SKETCH OF SITE		SESSION 3

	<p>SAME ←</p> <p style="font-size: 2em;">N</p>	<p>SAME ←</p> <p style="font-size: 2em;">N</p>	

<p>Describe any abnormalities and/or problems encountered during the survey, include session number, time of occurrence and duration.</p> <p>THE ANTENNA WAS MOUNTED DIRECTLY OVER PIER 2 WITH NO TRIPOD USED.</p> <p>ANTENNA HEIGHT WAS MEASURED VERTICALLY FROM GROUND PLANE TO BRASS DISK.</p>			

Figure 9-3. (Concluded)

**U.S. ARMY CORPS OF ENGINEERS
GPS DATA LOGGING SHEET**

PROJECT NAME _____ LOCALITY _____
 OBSERVER _____ AGENCY/FIRM _____
 RECEIVER _____ S/N _____
 ANTENNA _____ S/N _____
 DATA RECORDING UNIT _____ S/N _____
 TRIBRACH _____ S/N _____ LAST CALIBRATED: _____

	SESSION 1	SESSION 2	SESSION 3
STATION: NAME	_____	_____	_____
NUMBER	_____	_____	_____
DAY OF YEAR	_____	_____	_____
DATE MM DD YY	_____	_____	_____
UTC TIME OF OBSERVATION	START STOP	START STOP	START STOP

ANTENNA HEIGHT MEASUREMENTS

	SESSION 1	SESSION 2	SESSION 3
SLOPE @ BEGINNING	_____ IN= _____ M MN = _____ M	_____ IN= _____ M MN = _____ M	_____ IN= _____ M MN = _____ M
SLOPE @ END	_____ IN= _____ M MN = _____ M	_____ IN= _____ M MN = _____ M	_____ IN= _____ M MN = _____ M
MN ADJ TO VERT:	_____ M	_____ M	_____ M

	PROGRAMMED REFPOS	FIELD POSITION	PROGRAMMED REFPOS	FIELD POSITION	PROGRAMMED REFPOS	FIELD POSITION
LAT	_____	_____	_____	_____	_____	_____
LONG	_____	_____	_____	_____	_____	_____
HT	_____	_____	_____	_____	_____	_____
PDOP	_____	_____	_____	_____	_____	_____
SVS TO TRACK LOCAL	_____	_____	_____	_____	_____	_____
TIME: SCHEDULED	_____	_____	_____	_____	_____	_____
ACTUAL	_____	_____	_____	_____	_____	_____
START	_____	_____	_____	_____	_____	_____
STOP	_____	_____	_____	_____	_____	_____

PAGE 1

a. Front

Figure 9-4. Worksheet 9-1, USACE GPS Data Logging Sheet

U.S. ARMY CORPS OF ENGINEERS GPS DATA LOGGING SHEET			

	SESSION 1	SESSION 2	SESSION 3
ANT CABLE LENGTH	_____	_____	_____
POWER SUPPLY	_____	_____	_____
WEATHER CONDITIONS	_____ _____	_____ _____	_____ _____
MONUMENT TYPE	_____	_____	_____
EXACT STAMPING	_____	_____	_____
AGENCY CAST IN DISK	_____	_____	_____

	SESSION 1	SKETCH OF SITE SESSSION 2	SESSION 3
<div style="display: flex; justify-content: space-between; border-top: 1px solid black; border-bottom: 1px solid black;"> <div style="width: 30%; border-right: 1px dashed black;"></div> <div style="width: 40%; border-right: 1px dashed black;"></div> <div style="width: 30%;"></div> </div>			
***** Describe any abnormalities and/or problems encountered during the survey, include session number, time of occurrence and duration. *****			

PAGE 2			
b. Back			

Figure 9-4. (Concluded)

GPS SESSION FORM **CORPS OF ENGINEERS, JACKSONVILLE DISTRICT**

Jax Survey No.		Project Name		Date	
Agency/AE Project No.		Agency/AE Firm		Operator Name	
Monument Name/Designation			Exact Stamping <i>(include photo in survey report)</i>		
Monument No./PID		Agency Cast in Disk		File Name <i>(receiver generated)</i>	
Receiver Manufacturer		Receiver Model		Receiver Serial No.	
Data Collector Manufacturer		Data Collector Model		Data Collector Serial No.	
Antenna Part No.		Antenna Model		Antenna Serial No.	
Starting Antenna Height in Feet 1 2 3 AVG		Starting Antenna Height Meters 1 2 3 AVG		Type of Measurement <i>(circle one)</i> TRUE VERTICAL SLANT	
Ending Antenna Height in Feet 1 2 3 AVG		Ending Antenna Height in Meters 1 2 3 AVG		Type of Measurement <i>(circle one)</i> TRUE VERTICAL SLANT	
Antenna Reference Point <i>(include and reference a dimensioned diagram in Survey Report)</i> <i>e.g., bottom edge of notch in ground plane, Page 5, Figure 2</i>					
Start Date (UTC)		Start Time (UTC)		Approx. Lat. <i>(if available)</i>	
End Date (UTC)		End Time (UTC)		Approx. Lon. <i>(if available)</i>	
Describe any abnormalities and/or problems encountered during the session, include time of occurrence and duration.			Site Diagram		

version 20020912

ALL FIELDS REQUIRED UNLESS OTHERWISE NOTED
SUBMIT DIGITAL COPY OF ORIGINAL AND TYPED VERSIONS

Figure 9-5. Jacksonville District GPS Session Recording Form

	Station Designation: (check applicable: FBN / <input checked="" type="checkbox"/> GBN / PAC / SAC / <input checked="" type="checkbox"/> GIM) BALD 2 RESET	Station PID, if any: QE2736	Date (UTC): 31-Dec-98																																			
	General Location: Airport ID, if any: Boiler Bay Wayside ---	Station 4-Character ID: BALD	Day of Year: 365																																			
Project Name: Sample GPS, 1998		Project Number: GPS- 1234	Station Serial # (SSN): A																																			
NAD83 Latitude 44 49 49.17802	NAD83 Longitude 124 03 56.23447	NAD83 Ellipsoidal Height -6.44 meters	Agency Full Name: Oregon DOT Operator Full Name: John Q. Surveyor Phone #: () e-mail address: jqs@ordot.gov																																			
Observation Session Times (UTC): Sched. Start 12:00 Stop 17:30	Epoch Interval = 15 Seconds Elevation Mask = 10 Degrees	NAVD88 Orthometric Ht. 17.0 meters GEOID99 Geoid Height -23.52 meters																																				
GPS Receiver: Manufacturer & Model: Leica SR530 P/N: p/n 667122 S/N: s/n 0030354 Firmware Version: Version 3.0 <input checked="" type="checkbox"/> CamCorder Battery • 12V DC • 110V AC • Other		GPS Antenna: Manufacturer & Model: Trimble Choke Ring P/N: p/n 29659-00 S/N: s/n 02200-63591 Cable Length, meters: 30 meters Vehicle is Parked 25 meters N (direction) from antenna.																																				
Tripod or Ant. Mount: Check one: <input checked="" type="checkbox"/> Fixed-Height Tripod • <input type="checkbox"/> Slip-Leg Tripod • <input type="checkbox"/> Fixed Mount Manufacturer & Model: SECO P/N: none. S/N: 97-G Last Calibration date: 1998-11-01		** ANTENNA HEIGHT ** (see back of form for measurement illustration)																																				
Tribrach: Check one: <input checked="" type="checkbox"/> None • <input type="checkbox"/> Wild ODF 22 • <input type="checkbox"/> Tepecon • Other (describe) Last Calibration date:		<table border="1"> <thead> <tr> <th></th> <th>Before Session Begins: measure and record both Meters AND Feet</th> <th>After Session Ends: measure and record both Meters AND Feet</th> </tr> </thead> <tbody> <tr> <td>A = Datum point to Top of Tripod (Tripod Height)</td> <td>2.000</td> <td>2.000</td> </tr> <tr> <td>B = Additional offset to ARP if any (Tribrach/Spoor)</td> <td>-0.003</td> <td>-0.003</td> </tr> <tr> <td>H = Antenna Height = A + B = Datum Point to Antenna Reference Point (ARP)</td> <td></td> <td></td> </tr> </tbody> </table>			Before Session Begins: measure and record both Meters AND Feet	After Session Ends: measure and record both Meters AND Feet	A = Datum point to Top of Tripod (Tripod Height)	2.000	2.000	B = Additional offset to ARP if any (Tribrach/Spoor)	-0.003	-0.003	H = Antenna Height = A + B = Datum Point to Antenna Reference Point (ARP)																									
	Before Session Begins: measure and record both Meters AND Feet	After Session Ends: measure and record both Meters AND Feet																																				
A = Datum point to Top of Tripod (Tripod Height)	2.000	2.000																																				
B = Additional offset to ARP if any (Tribrach/Spoor)	-0.003	-0.003																																				
H = Antenna Height = A + B = Datum Point to Antenna Reference Point (ARP)																																						
Barometer: Manufacturer & Model: pretel altiplus A2 P/N: none. S/N: J.Q.S. Last Calibration or check Date: 11-Sep-01		<table border="1"> <thead> <tr> <th>Weather DATA</th> <th>Time (UTC)</th> <th>Dry-Bulb Temp Fahrenheit Celsius</th> <th>WetBulb Temp Fahrenheit Celsius</th> <th>Rel. % Humidity</th> <th>Atm. Pressure Inches Hg millibar</th> <th>Weather Codes *</th> </tr> </thead> <tbody> <tr> <td>Before</td> <td>12:00</td> <td>74.0</td> <td>68.0</td> <td>74</td> <td>29.4</td> <td>00000</td> </tr> <tr> <td>Middle</td> <td>14:45</td> <td>77.0</td> <td>72.5</td> <td>81</td> <td>29.6</td> <td>00001</td> </tr> <tr> <td>After</td> <td>17:30</td> <td>82.5</td> <td>78.0</td> <td>82</td> <td>29.7</td> <td>00102</td> </tr> <tr> <td colspan="7">Average of Readings</td> </tr> </tbody> </table>		Weather DATA	Time (UTC)	Dry-Bulb Temp Fahrenheit Celsius	WetBulb Temp Fahrenheit Celsius	Rel. % Humidity	Atm. Pressure Inches Hg millibar	Weather Codes *	Before	12:00	74.0	68.0	74	29.4	00000	Middle	14:45	77.0	72.5	81	29.6	00001	After	17:30	82.5	78.0	82	29.7	00102	Average of Readings						
Weather DATA	Time (UTC)	Dry-Bulb Temp Fahrenheit Celsius	WetBulb Temp Fahrenheit Celsius	Rel. % Humidity	Atm. Pressure Inches Hg millibar	Weather Codes *																																
Before	12:00	74.0	68.0	74	29.4	00000																																
Middle	14:45	77.0	72.5	81	29.6	00001																																
After	17:30	82.5	78.0	82	29.7	00102																																
Average of Readings																																						
Psychrometer: Manufacturer & Model: Psychrodyne S/N: J.Q.S.		Note: Meters = Feet X (0.3048) Height Entered Into Receiver = 2.000 meters.																																				
Remarks, Comments on Problems, Sketches, Pencil Rubbing, etc: 1. Winds, calm at start, gradually increased to 20 knots by end of session. 2. Semi-trailer parked 12 meters SSE of antenna from 15:17 to 15:32 UTC, possibly blocking satellites and causing multipath environment. 3. Center pole of tripod projected 3 mm into dimple of disk. Antenna height was therefore 2 m - 3 mm = 1.997 m <small>Note: Entries are Required in all Unshaded areas.</small>																																						
Data File Name(s): BALD365A.dat <small>(Standard NGS Format = aaadddd.xxx) where aa=4-Character ID, ddd=Day of Year, s=Session ID, xxx=file dependent extension</small>		Updated Station Description: <input checked="" type="checkbox"/> Attached • Submitted earlier Visibility Observation Form: <input checked="" type="checkbox"/> Attached • Submitted earlier Photographs of Station: <input checked="" type="checkbox"/> Attached • Submitted earlier Pencil Rubbing of Mark: <input checked="" type="checkbox"/> Attached		LOG CHECKED BY: JGE																																		

Figure 9-6. NGS Station Observation Log (Page 1)

ILLUSTRATION FOR ANTENNA HEIGHT MEASUREMENTS:

I. Instructions for Fixed-Height Tripods:

Measure & record the fixed-height tripod length (A) and other offsets, if any, between the tripod and the Antenna Reference Point (ARP) (B)

$$\text{Antenna Height} = H = A + B$$

II. Instructions for Slip-Leg Tripods:

1. Measure the Slant Height (S)

Measure the slope distance from the mark to at least three notches on the Bottom of Ground Plane (BGP) using two independent rulers (e.g., metric and imperial). Record measurements in the table below, and compute the average.

Measure S	Notch #	Notch #	Notch #	Average
Before, cm	223.40	223.30	223.30	
Before, inch	87.95	87.94	87.93	
After, cm	223.40	223.40	223.30	
After, inch	87.97	87.96	87.95	
Note: cm = inch x (2.54)		Overall average, cm		

S = _____ cm

2. Record the Antenna Radius (R) and the Antenna Constant (C)

The antenna radius (R) is the horizontal distance from the center of the antenna to the measurement notch. The antenna constant (C) is the vertical distance from the ARP to the BGP. Consult your antenna users manual for exact measurements.

R = 19.05 cm

C = 3.50 cm

3. Compute Antenna Height (H)

Use the following Pythagorean equation:

$$\text{Antenna Height} = H = ((\sqrt{S^2 - R^2}) - C)$$

$$\text{Antenna Height} = H = a + b$$

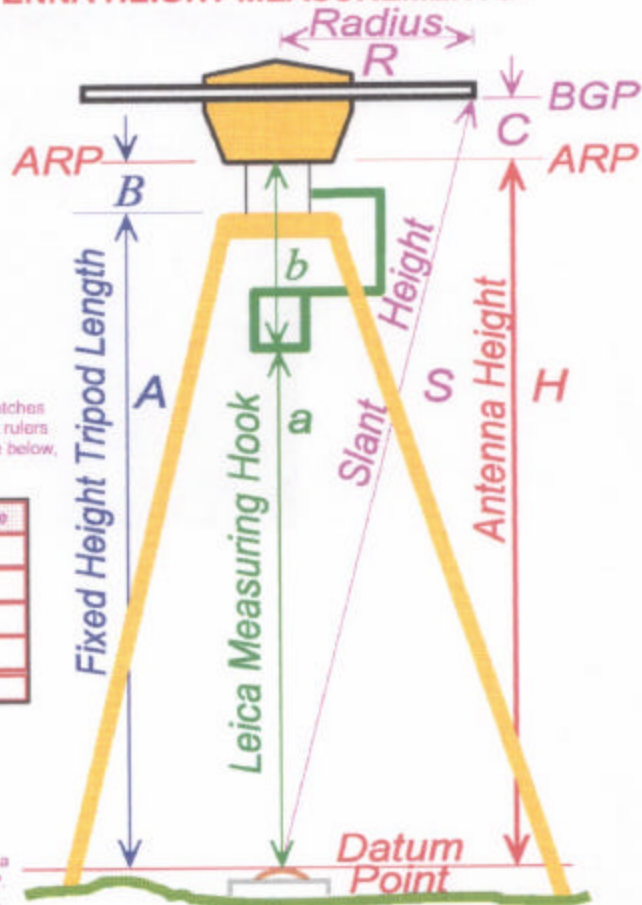

III. Instructions for using the Leica Brand Measuring Hook:

Follow the Leica operating instructions, being sure to reduce the height to the Antenna Reference Point (ARP), NOT the L1 Phase Center.

Table of Weather Codes -- for entry into Weather Data Table on front of form:					
CODE	PROBLEM	VISIBILITY	TEMPERATURE	CLOUD COVER	WIND
0	NO PROBLEMS encountered	GOOD More than 15 miles	NORMAL 32° F to 80° F	CLEAR Below 20%	CALM Under 5mph (8km/h)
1	PROBLEMS encountered	FAIR 7 to 15 miles	HOT Over 80° F (27 C)	CLOUDY 20% to 70%	MODERATE 5 to 15 mph
2	- NOT USED -	POOR Less than 7 miles	COLD Below 32° F (0 C)	OVERCAST Over 70%	STRONG ovr15mph (24km/h)
Examples: Code 00000 = 0 - No problems, 0 - good visibility, 0 - normal temperature, 0 - clear sky, 0 - calm wind Code 12121 = 1 - Problems, 2 - poor visibility, 1 - hot temperature, 2 - overcast, 1 - moderate wind					

Figure 9-6. (Concluded) NGS Station Observation Log (Page 2)

Section I: Conducting Absolute GPS Positioning and Navigation Surveys

9-3. General

Absolute point positioning GPS receivers acquire and process satellite range data to provide 10-30 meter horizontal accuracy positions. This real-time positional data is typically displayed on a hand-held receiver screen, either in numeric or graphic (navigation) format, depending on the application. Numerous hand-held receivers are available for real-time dynamic navigation uses. Although absolute positional data are most often expressed in real time, some mapping-grade receivers can post-process data if station occupation was static over a period of time--e.g., 6 to 24 hours. The post-processing produces a best-fit point position and meter-level accuracy can be achieved--dual-frequency receivers using the precise ephemeris can produce even better (sub-meter) absolute positional accuracies. Absolute positions are based on the WGS 84 ellipsoid. Therefore, observed horizontal positions need to be transformed to a local reference datum (e.g., NAD 83) and ellipsoid elevations need to be corrected for geoid undulation in order to obtain approximate orthometric elevations on either NAVD 88 or NGVD 29.

9-4. Absolute Point Positioning Techniques

Absolute point positioning techniques are employed where differential techniques are impractical and a new reference point is needed. This might occur in some OCONUS locations. Given the ready availability of automated differential techniques in CONUS (e.g., FAA WAAS, USCG radiobeacon) there is no longer any need to perform absolute point positioning. There are two techniques used for point positioning in the absolute mode. They are long term averaging of positions and differencing between signals.

a. In long-term averaging, a receiver is set up to store positions over a fixed period of time. The length of observation time varies based upon the accuracy required. The longer the period of data collection, the better the average position will be. This observation time can range between 1 and 24 hours. This technique can also be done in real-time (i.e. the receiver averages the positions as they are calculated). For example, the military PLGR GPS receiver uses this technique in calculating a position at a point. Positions can be stored at either 15, 30, or 60 second intervals, depending on storage capacity and length of observation. Typically, a 24-hour observation period is used to obtain an absolute point position accurate to the meter-level.

b. The process of differencing between signals can only be performed in a post-processed mode. NIMA (formerly Defense Mapping Agency) has produced software that can perform this operation. There are few USACE requirements for this technique.

9-5. Absolute GPS Navigation Systems

General vehicle and vessel navigation systems typically use inexpensive single-frequency GPS receivers. Various types of these receivers are sold at prices ranging from \$100 to \$1,000, depending largely on the display and software options. Operation of these receivers is simple and briefly explained in operating manuals provided with the device. Some receivers can log feature data for subsequent download to a GIS. Other receivers can log code and carrier phase data for post-processing adjustment to a reference station such as CORS. A typical receiver is shown in Figure 9-7. This receiver weighs only 5.3 ounces and has a high-contrast LCD display. It can save up to 500 waypoints and contains more than 100 map datums.



Figure 9-7. Garmin eTrex handheld differential-ready 12 parallel channel GPS receiver

9-6. Mapping Grade GPS Receivers



Figure 9-8. Real-time, meter-level accuracy, feature mapping-grade GPS backpack systems

A variety of mapping grade GPS receivers are available to collect and process real-time absolute and code differential positional data, post-processed carrier differential positional data, and correlate these positions with CADD/GIS map features. These georeferenced features can then be exported into a specific GIS platform. These mapping grade receiver systems, including software, range in cost between \$3,000 and \$10,000. Field operation of these receivers is fairly straightforward and is described in operating manuals

referenced in the following sections. The following paragraphs briefly describe some of the operational capabilities of two Trimble mapping grade receivers: the GeoExplorer 3 and the GPS Pathfinder.

a. Trimble GeoExplorer 3. The GeoExplorer 3 data collection system is an integrated GPS receiver and data collector for mapping, relocating, and updating GIS and spatial data. The system is used with the GPS Pathfinder Office software for mission planning, data transfer, data dictionary creation, data import/ export, and post-processing. The GeoExplorer 3 data collection system can operate as a rover receiver or as a base station--typically using meter-level accuracy code data acquired from USCG radiobeacon stations or from commercial wide area providers. It can also collect high-precision data using differential GPS carrier phase measurements. The data collector can navigate, collect data, view system status and satellite availability, and control the GPS receiver. The GeoExplorer 3 data logger is designed for handheld use in the field. It has an internal antenna and power source, and a high-performance 12-channel GPS receiver. Accessories, such as external antennas or power kits, are available. The primary functions of the GeoExplorer 3 data collection system are collecting geographic data, using and updating existing GIS data, and navigating in the field. It can collect the feature attributes and GPS position of geographic points, lines, and areas. This information is stored in one or more data files that can later be transferred to Trimble's GPS Pathfinder Office software for postprocessing and editing. Data can then be exported into a variety of CADD/GIS compatible formats. The GeoExplorer 3 can be configured to update data from an existing GIS or CADD database. It can also be used to navigate to specific locations, using either absolute point positioning or real-time differential GPS, using the optional Beacon-on-a-Belt (BoB) beacon receiver. Feature data dictionaries can be created or edited in the office with the GPS Pathfinder Office software or in the GeoExplorer 3 data collection system. Applications for the GeoExplorer 3 include utility mapping and locating, forestry mapping, environmental and resource management, disaster assessment, and urban asset management. For further details on the GeoExplorer 3 system refer to *GeoExplorer 3 Operation Guide* (Trimble 2001f).

b. Trimble Pathfinder Pro XR/XRS. The Pathfinder Pro XR/XRS 12-channel, dual-frequency receivers are capable of processing absolute GPS positioning data, MSK radiobeacon DGPS code corrections, and satellite differential corrections from commercial providers, such as Fugro OmniSTAR and Thales LandSTAR. These systems can also process code differential corrections from an external fixed reference receiver--such that decimeter-level and centimeter-levels can be obtained. The GPS and radiobeacon antennas are combined into a single unit. Sub-meter positional accuracy is achieved if a compatible Trimble reference station is used. More accurate differential carrier phase data can also be collected for post-processing. Carrier phase data and mapped feature data can be exported to a post-processing program such as Pathfinder Office. The Pathfinder system is typically configured in a backpack assembly that contains the receiver, battery pack, antenna pole, and GPS/MSK beacon antenna. For further details on this system, see *GPS Pathfinder Systems Receiver Manual* (Trimble 2001e).

c. GPS Pathfinder Office. GPS Pathfinder Office is typical of software designed to manage and process data collected by mapping grade GPS receivers. It is especially designed to configure and export feature data into GIS or CADD databases. Other features include: design or construction of feature data dictionaries, CADD/GIS database format conversions, file transferring from handheld data collectors, and differentially processing GPS data between a reference base station and a rover unit. This processing software is described in *GPS Pathfinder Office* (Trimble 2002a).

Section II: Conducting Differential GPS Code Phase Positioning and Mapping Surveys

9-7. General

Differential (or relative) GPS surveying is the determination of one location with respect to another location. When using this technique with the C/A or P-code it is called differential code phase positioning, as distinct from carrier phase positioning techniques covered in the next section. Differential code phase positioning has limited application to detailed engineering control surveying and topographic site plan mapping applications. However, it is widely used for general reconnaissance surveys, hydrographic survey positioning, offshore core drilling rig positioning, dredge positioning, and some operational military survey support functions. Additional applications for relative code phase positioning have been on the increase as positional accuracies have improved. Real-time, meter-level DGPS correctors can be obtained from the USCG radiobeacon navigation service or from a variety of commercial wide-area augmentation systems. This section primarily focuses on the USCG radiobeacon system; however, a number of commercial augmentation systems are also capable of providing comparable (or better) survey positioning capability. Some of those commercial systems having USACE application are described. Calibration guidance in this section is applicable to all these augmentation systems.

9-8. USCG DGPS Radiobeacon Navigation Service

a. General. The USCG radiobeacon system is by far the most widely applied use of code phase GPS in USACE--in fact, the Corps funds and operates some USCG radiobeacon stations at various points along the Mississippi River and tributaries. This real-time positioning system is used for nearly all dredge positioning and hydrographic survey operations in USACE. In the past, Loran-C and Omega systems were used as the primary positioning tools for marine navigation. Today, the USCG is making use of the full coverage from GPS for a more accurate positioning tool for marine navigation. Utilizing DGPS and marine radiobeacon technology, the USCG has designed a real-time positioning system for the coastal areas and Great Lakes regions of the US. The USCG has also partnered with USACE and other government agencies to expand this coverage to inland waterways and eventually over the entire nation. The system consists of a series of GPS reference stations with known coordinate values based on the North American Datum of 1983 (NAD 83) datum. GPS C/A-code pseudorange corrections are computed based on these known coordinate values and transmitted via a marine radiobeacon. A user with a marine radiobeacon receiver and a GPS receiver with the ability to accept and apply pseudorange corrections can obtain a relative accuracy of 0.5-3 meters. This accuracy is dependent on many factors including the design and quality of the user's GPS receiver, distance from the reference station, and the satellite geometry. This service can be used for all USACE hydrographic surveys and dredge positioning requiring an accuracy of 0.5 to 3 meters.

b. Site set-up and configuration. Each USCG radiobeacon site consists of two GPS L1/L2 geodetic receivers (as reference station receivers) with independent geodetic antennas to provide redundancy, and a marine radiobeacon transmitter with transmitting antenna. The site is also equipped with two combined L1 GPS / Modulation Shift Key (MSK) receivers which are used as integrity monitors. Each combined receiver utilizes an independent GPS antenna and a MSK near-field passive loop antenna.

(1) Site Location. The location of the reference station GPS antennas are tied into the North American Datum of 1983 (NAD 83) and the International Terrestrial Reference Frame (ITRF). The geodetic coordinates for these positions were determined by NGS. DGPS pseudorange corrections are based on measurements made by the reference receiver relative to the NAD 83 antenna coordinates.

These pseudorange corrections are then transmitted via the marine radiobeacon to all users having the necessary equipment.

(2) Data Transmission (data types). The corrections are transmitted using the Type 9-3 message format designated by the Radio Technical Commission for Maritime Services Special Committee 104 (RTCM SC-104). Other RTCM SC-104 message types transmitted to the user include Type 3 (contains the NAD 83 coordinates for the broadcast site), Type 5 (provides information if a GPS satellite is deemed unhealthy), Type 7 (information on adjacent radiobeacons), and Type 16 (alerts the user of any outages). More detailed descriptions of these message types can be downloaded from the USCG Navigation Center (NAVCEN) web site.

(a) Pseudorange corrections are generated for a maximum of nine satellites tracked by the reference station GPS receiver at an elevation angle of 5 degrees or higher above the horizon. Satellites below a 5-degree elevation mask are highly susceptible to multipath and spatial decorrelation. If there are more than nine satellites observed at the reference station above 5 degrees, then the corrections broadcast are based on the nine satellites with the highest elevation angle.

(b) The sites transmit these corrections at a 100 or 200 baud rate. Since a Type 9-3 message is 210 bits (includes header information and corrections for three satellites), the latency of the data is 2.1 seconds for a site transmitting at 100 baud. For stations transmitting at 200 baud, the latency would be half, or 1.05 seconds. The user can expect a latency of 2 to 5 seconds for all of the corrections for a group of satellites observed at the reference station to reach them. A correction can be considered valid for a period of 10 to 15 seconds from generation (the USCG limit is 30 seconds). Using corrections beyond this period of time, especially for positioning of a moving platform, may cause spikes in the positional results.

c. Availability and reliability of the system. The system was designed for and operated to maintain a broadcast availability (i.e. transmitting healthy pseudorange corrections) that exceeds 99.7% (in designed coverage areas) assuming a healthy and complete GPS constellation. The signal availability, in most areas, will be higher due to the overlap of broadcast stations. The USCG monitors each site within the entire system for problems or errors, and immediately alerts users of any problems. Each site is equipped with two integrity monitors (i.e. a GPS receiver with a MSK radiobeacon) whose antennas are mounted over known positions. The integrity monitors receive the pseudorange corrections from that site and compute a check position. The computed or corrected position is compared to the known location to determine if the corrections are within the expected tolerance. The corrected positions calculated by the integrity monitors are sent via phone lines to the control monitoring stations. For the stations east of the Mississippi River, this information is sent to USCG's NAVCEN in Alexandria, Virginia. Sites west of the Mississippi River send their corrected positions to the NAVCEN Detachment in Petaluma, California. Users are notified via the type 16 message of any problems with a radiobeacon site within 10 seconds of an out-of-tolerance condition.

d. Coverage. The system was designed to cover all harbors and harbor approach areas and other critical waterways for which USCG provides aids to navigation. Each site has a coverage area between 150 to 300 miles, depending on the transmitter power, terrain, and signal interference. Since the sites utilize an omnidirectional transmitting antenna, some areas have overlapping coverage. Currently the system covers all US coastal harbor areas, the Mississippi and part of the Missouri and Ohio Rivers, and the Great Lakes Region. Additional areas within the Midwest and other non-coastal areas are being added to provide nationwide coverage, under the Nationwide DGPS program (NDGPS). Figure 9-9 depicts existing and planned radiobeacon coverage as of 2002. An updated map of the coverage area can be found at the NAVCEN web site under the DGPS section.

e. User requirements and equipment. To receive and apply the pseudorange corrections generated by the reference station, the user needs to have a MSK radiobeacon receiver with antenna and, at a minimum, a L1 C/A-code GPS receiver with antenna. The MSK receiver demodulates the signal from the reference station. Most MSK receivers will automatically select the reference station with the strongest signal strength to observe from or allow the user to select a specific reference station. A MSK receiver can be connected to most GPS receivers. The costs of radiobeacon receivers range from \$500 to \$2000. The GPS receiver must be capable of accepting RTCM Type 9 messages and applying these corrections to compute a "meter-level" position. Since the reference station generates corrections only for satellites above a 7.5-degree elevation, satellites observed by the user's GPS receiver below a 7.5-degree elevation will not be corrected. Some receiver manufacturers have developed a combined MSK radiobeacon and GPS receiver with a combined MSK and GPS antenna. For a combined radiobeacon/GPS receiver, prices range from \$2,000 to \$5,000.

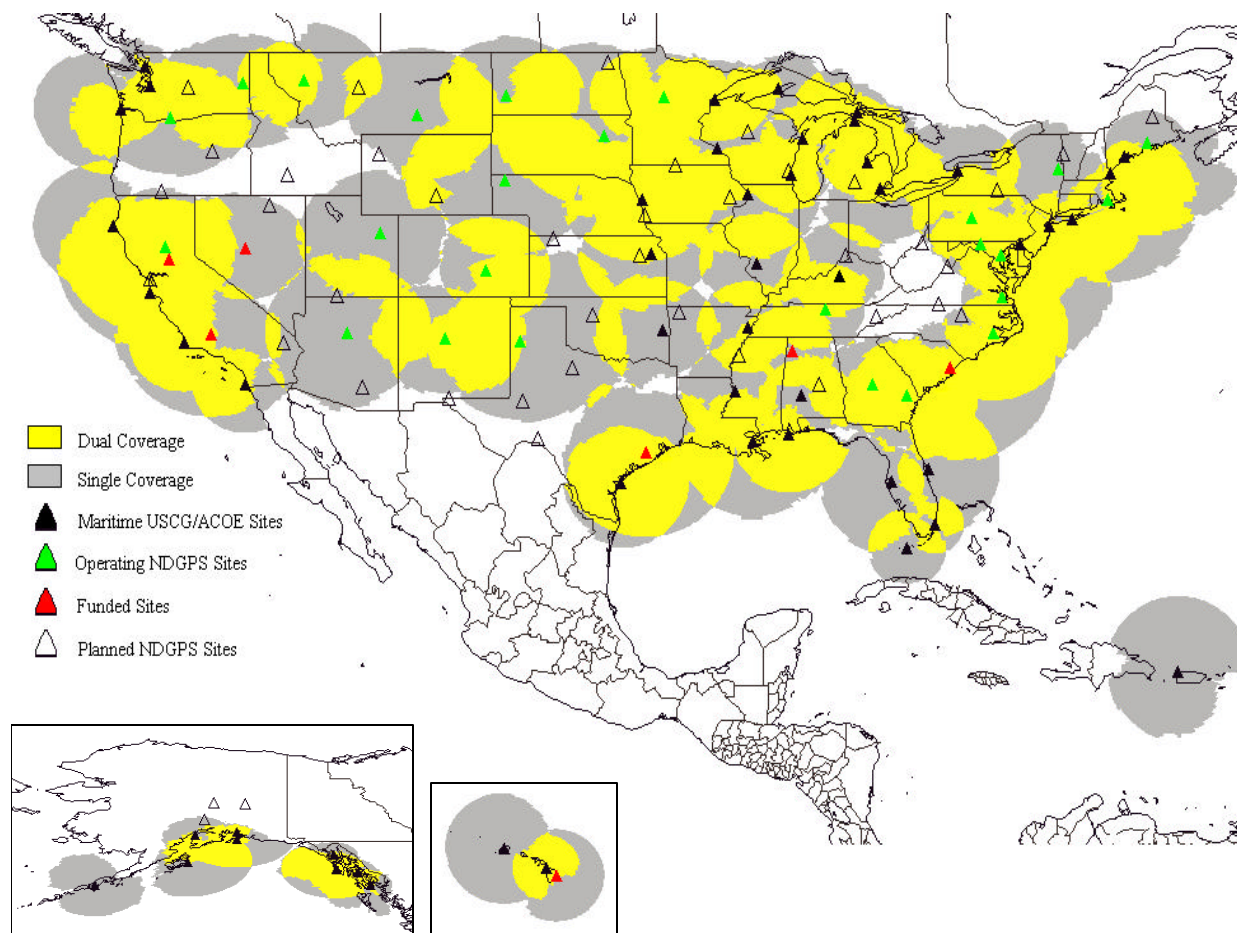

Figure 9-9. USCG Radiobeacon MDGPS and NDGPS coverage--current (2002) and planned stations

f. Position QC tolerance checks. Most precise DGPS augmentation systems are capable of providing sub-meter accuracies at reasonable distances from the nearest reference station. However, at increasing distances, spatial decorrelation errors (due to differing ionospheric/tropospheric conditions) can induce systematic positional biases. In general, under nominal atmospheric conditions, a 2-meter RMS (95%) positional accuracy may be achieved at distances upwards of 150 miles. To confirm a positional accuracy is within this 2-meter tolerance, it is strongly recommended that a static check position be obtained at some known survey point near the project. When operating with the USCG radiobeacon system, static positions should be observed from different radiobeacon reference stations to ascertain if positional systematic biases are present--and select the beacon with minimal biases. In practice, this would normally be the closest beacon. If no fixed survey point is available, then a static comparison of different beacon positions should be observed; however, any large biases between beacon positions may be ambiguous. When large or ambiguous positional biases occur in a project area, it may be necessary to establish a local DGPS network (code or RTK carrier) if high positional accuracy is critical to the project. Commercial wide area DGPS systems should be checked in a similar manner.

9-9. FAA Wide Area Augmentation System (WAAS)

The FAA's WAAS is a GPS-based navigation and landing system that will provide precision guidance to aircraft at thousands of airports and airstrips where there is currently no precision landing capability. Although still under development, this system will have potential USACE positioning, mapping, and navigation applications; either as a primary or supplemental positioning system. Many GPS receivers have been developed to acquire and process FAA WAAS signals--e.g., Garmin, Magellan, Trimble ProXR/XRS. As with most augmentation systems, WAAS is designed to improve the accuracy and ensure the integrity of information coming from GPS satellites.

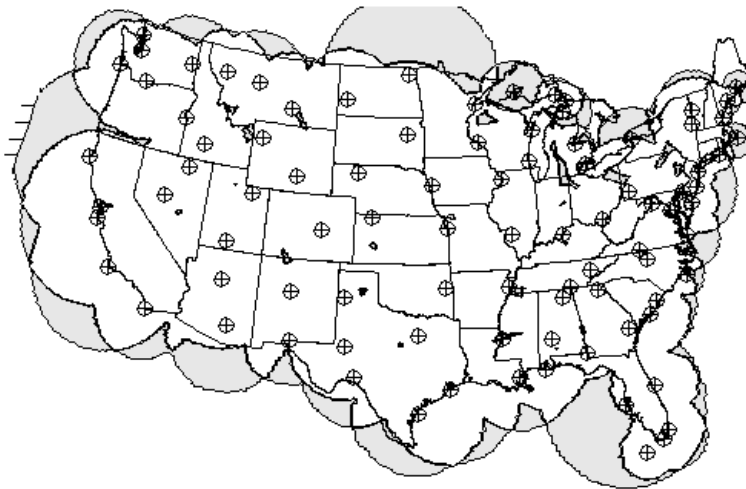

Figure 9-10. Proposed FAA WAAS coverage in CONUS

a. FAA WAAS is based on a network of ground reference stations that cover a very large service area--see Figure 9-10. Signals from GPS satellites are received by wide area ground reference stations (WRSs). Each of these precisely surveyed reference stations receives GPS signals and determines if any errors exist. These WRSs are linked to form the US WAAS network. Each WRS in the network relays the data to the wide area master station (WMS) where correction information is computed. The WMS calculates correction algorithms and assesses the integrity of the system. A correction message is prepared and uplinked to a geosynchronous satellite via a ground uplink system. The message is then broadcast from the satellite on the same frequency as GPS (L1--1575.42 MHz) to receivers on board aircraft (or ground-based hand-held receivers) that are within the broadcast coverage area and are capable of receiving FAA WAAS corrections. These communications satellites also act as additional navigation satellites for the aircraft, thus providing additional navigation signals for position determination. The FAA WAAS will improve basic GPS accuracy to approximately 7 meters vertically and horizontally, improve system availability through the use of geostationary communication satellites (GEOs) carrying navigation payloads, and provide important integrity information about the entire GPS constellation.

b. At present there are two geostationary satellites serving the WAAS area (Inmarsat IIIs: POR (Pacific Ocean Region) and AOR-W (Atlantic Ocean Region-West)--see Figure 9-11. The European area will eventually be served by two Inmarsats, AOR-E (Atlantic Ocean Region-East) and IOR (Indian Ocean Region) and the European Space Agency satellite, ARTEMIS. Europe's Geostationary Navigation Overlay Service (EGNOS) is Europe's first venture into satellite navigation and is Europe's first stage of the Global Navigation Satellite System (GNSS). EGNOS is a precursor to GALILEO, the full global satellite navigation system under development in Europe. On the future ARTEMIS satellite, the GPS/GLONASS augmentation is made directly from aircraft based equipment. In Asia, Japan is developing the Multi-functional Satellite Augmentation System (MSAS).

c. EGNOS & WAAS do not currently share almanac information, and EGNOS is broadcasting a "do not use" indication. So it is unlikely that users in Europe will see any response from EGNOS until their systems share more information and allow use of the corrections.

d. *Garmin WAAS receiver operation.* Garmin is typical of receivers that have been configured to receive FAA WAAS corrections. Garmin units can access 19 WAAS/EGNOS/MSAS unique GEO satellites. They are depicted on the GPS as Satellite IDs 33-51, which is actually a NMEA convention. Each WAAS/EGNOS/MSAS satellite will have its own unique PRN code assigned from the list of 19. These satellites do not move on the screen as do the other GPS low-earth-orbit satellites. Garmin receivers use one or two channels to track WAAS satellites and they will use the WAAS satellite in the position solution, if the WAAS system indicates it is OK to use for navigation. Sometimes the WAAS satellite is flagged as "do not use for navigation" but the corrections are still useful.

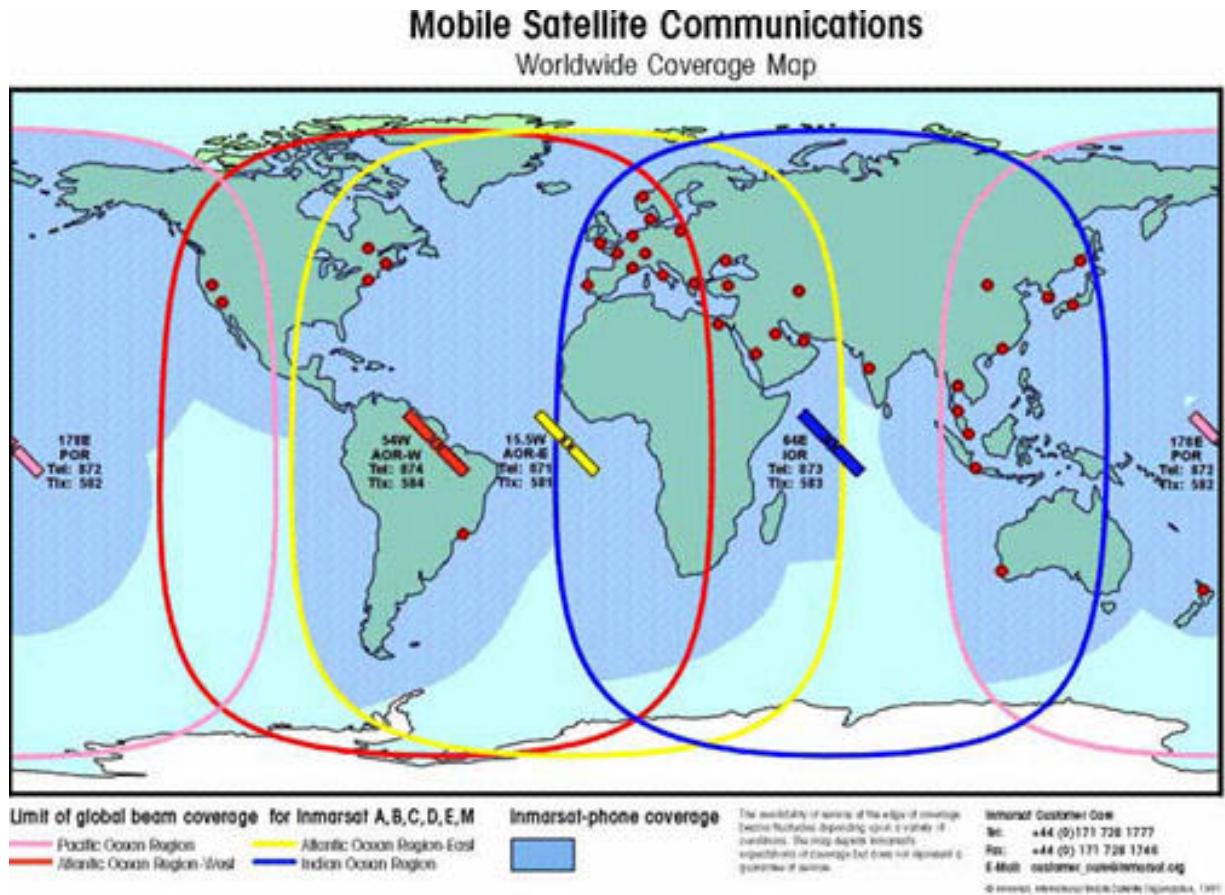

Figure 9-11. Inmarsat global coverage

9-10. FAA Local Area Augmentation System (LAAS)

The FAA is also developing a Local Area Augmentation System (LAAS) for high accuracy aircraft landing. This LAAS will include a ground facility that has four Reference Receivers (RR), RR antenna pairs, redundant Very High Frequency Data Broadcast (VDB) equipment feeding a single VDB antenna, and equipment racks. These sets of equipment are installed on the airport property where LAAS is intended to provide service. The ground facility receives, decodes, and monitors GPS satellite information and produces correction messages. To compute corrections, the ground facility calculates position based on GPS, and then compares this position to their known location. Once the corrections are computed, a check is performed on the generated correction messages to help ensure that the messages will not produce misleading information for the users. This correction message, along with suitable integrity parameters and approach path information, is then sent to the airborne LAAS user(s) using the VDB from the ground-based transmitter. Airborne LAAS users receive this data broadcast from the ground facility and use the information to assess the accuracy and integrity of the messages, and then compute accurate Position, Velocity, and Time (PVT) information using the same data. This PVT is utilized for the area navigation guidance and for generating Instrument Landing System (ILS)-look-alike guidance to aid the aircraft on an approach. Although these FAA LAAS systems will not have any direct USACE application, the technology developed by the FAA may have use on unique Corps projects where high-accuracy real-time positioning is required, such as in obstructed areas.

9-11. OmniSTAR Wide-Area Differential Positioning Service

OmniSTAR is typical of a commercial "fee-for-service" wide-area differential GPS system, using satellite broadcast techniques to deliver accurate GPS correctors. Data from many widely spaced reference stations is used in a proprietary multi-site solution to achieve sub-meter positioning over most land areas worldwide. OmniSTAR is proprietary system operated by the Fugro group. Corps applications include all mapping and navigation solutions where the USCG or FAA WAAS systems are not available or are blocked.

a. OmniSTAR provides worldwide DGPS coverage with 70 reference stations around the globe and 3 network control centers. The OmniSTAR service was developed to satisfy the need for an accurate positioning system for new applications on land. The OmniSTAR service offers real-time, DGPS positioning. The system is characterized by portable receiving equipment, suitable for vehicle mounting or "back-pack" use. OmniSTAR supports applications across a wide range of industries including agriculture (precision farming), mining, and land survey. Aerial applications include crop dusting and geophysical surveys.

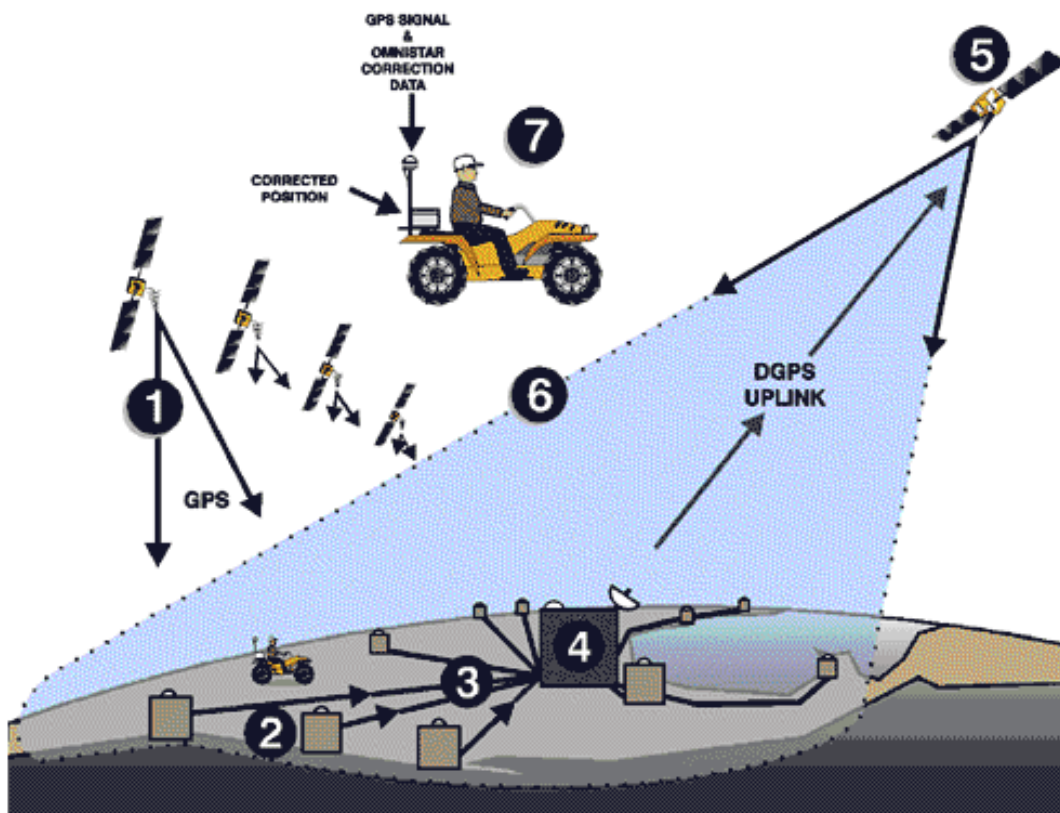

Figure 9-12. OmniSTAR concept. 1. GPS satellites. 2. Multiple OmniSTAR GPS monitor sites. 3. Send GPS corrections via lease line to 4. Houston Network Control Center where data corrections are checked and repackaged for uplink to 5. L-Band Geostationary Satellite. 6. GE Spacenet 3 broadcast footprint OmniSTAR user area. 7. Correction data are received and applied real-time.

OmniSTAR's "Virtual Base Station" technology generates corrections optimized for the user's location. OmniSTAR receivers output both high quality RTCM SC-104 Version 2 corrections and differentially corrected Lat/Long in NMEA format.

b. Technical description. The OmniSTAR system generates pseudorange corrections for differential users. This is accomplished by the use of one or more "Base Stations" that measure the errors in the GPS pseudoranges and generates corrections. The method of generating corrections is similar to other DGPS service systems. The OmniSTAR DGPS System was designed with the following objectives: (1) continental coverage; (2) sub-meter accuracy over the entire coverage area; and (3) a portable system. The first objective dictated that transmission of the corrections had to be from a geostationary satellite. The AMSC Satellite, located at 101 degrees West Longitude, has three individual beams that together cover all of North America from 60 degrees North Latitude to the Southern border of Mexico. It has sufficient power within that footprint that a small omnidirectional antenna may be used for receiving. The frequency of the OmniSTAR Geostationary Satellite is sufficiently close to that of GPS that in most instances, a common, single antenna, may be used. The methodology developed by OmniSTAR consists of using multiple GPS base stations in a user's solution and reducing errors due to the GPS signal traveling through the atmosphere. OmniSTAR was the first widespread use of a "Wide Area DGPS Solution." The OmniSTAR solution uses data from a relatively small number of base stations to provide consistent accuracy over large areas. A method of solving for atmospheric delays and weighting of distant base stations achieves sub-meter capability over the entire coverage area--regardless of the user's location relative to any base station. This achieves a wide-area system with consistent characteristics. A user can take his equipment anywhere within the coverage area and get consistent accuracy results, without any intervention or intimate knowledge of GPS or DGPS.

c. Network operation. The OmniSTAR network consists of ten permanent base stations in the CONUS plus one in Mexico. These eleven stations track all GPS satellites above 5 degrees elevation and compute corrections every 600 milliseconds. The corrections are in RTCM SC-104, Version 2 message format. The corrections are then sent to the OmniSTAR Network Control Center (NCC) in Houston via wire networks. At the NCC these messages are checked, compressed, and formed into packets for transmission up to the OmniSTAR satellite transponder. This occurs approximately every few seconds. A packet will contain the latest corrections from each of the North American base stations. All OmniSTAR user sets receive these packets of data from the satellite transponder. The messages are first decoded and uncompressed. At that point, the message is an exact duplicate of the data as it was generated at each base station. Next, the atmospheric errors must be corrected as described below.

(1) Every base station automatically corrects for atmospheric errors at its location, because it is a part of the overall range error; but the user is likely not at any of those locations, so the corrections are not optimized for the user. Also, the OmniSTAR system has no information as to each individual's location. If these corrections are to be automatically optimized for each user's location, then it must be done in each user's OmniSTAR. For this reason, each OmniSTAR user set must be given an approximation of its location. The approximation only needs to be within several miles of its true position. Given that information, the OmniSTAR user set can use a model to compute and remove most of the atmospheric correction contained in satellite range corrections from each Base Station message, and substitute a correction for its own location. In spite of the loose approximation of the user's location, this information is crucial to the OmniSTAR process. It makes the operation totally automatic and it is necessary for sub-meter positioning. If it is totally ignored, errors of several meters can result.

(2) Fortunately, this requirement of giving the user's OmniSTAR an approximate location is easily solved. OmniSTAR is normally purchased as an integrated GPS/DGPS System, and the problem is taken care of automatically by using the position out of the GPS receiver as the approximation. It is wired internally to do exactly that.

(3) After the OmniSTAR processor has taken care of the atmospheric corrections, it then uses its location in an inverse distance-weighted least-squares solution. The output of that least-squares calculation is a synthesized RTCM SC-104 correction message that is optimized for the user's location. It is always optimized for the user's location that is input from the user's GPS receiver. This technique of optimizing the corrections for each user's location is called the "Virtual Base Station Solution." It is this technique that enables the OmniSTAR user to operate independently and consistently over the entire coverage area without regard to where he is in relation to the base stations.

(4) In most world areas, a single satellite is used by OmniSTAR to provide coverage over an entire continent--or at least very large geographic areas. In North America, a single satellite is used, but it needs three separate beams to cover the continent. The three beams are arranged to cover the East, Central, and Western portions of North America. The same data is broadcast over all three beams, but the user system must select the proper beam frequency. The beams have overlaps of several hundred miles, so the point where the frequency must be changed is not critical. Most recent models will search and select the strongest beam automatically, but older receivers must be manually set to the proper frequency. An approximation for the changeover from Eastern to the Central beam would be at a line from Detroit to New Orleans. The Central and Western Beams are divided at a line from Denver to El Paso. Again, these are approximations. All of the eastern Canadian Provinces, the Caribbean Islands, Central America (south of Mexico), and South America is covered by a single Satellite (AM-Sat). A single subscription service is available for all the areas covered by this satellite.

(5) OmniSTAR currently has several high-powered satellites in use around the world. They provide coverage for most of the world's land areas. Subscriptions are sold by geographic area. Any regional OmniSTAR Service Center can sell and activate subscriptions for any area. They may be arranged prior to traveling to a new area, or after arrival.

d. Equipment requirements. Several GPS manufacturers currently build models that combine OmniSTAR and GPS in one unit, using a common antenna. These are geodetic quality GPS receivers that have sub-meter capabilities. All are physically small and can be battery operated. They may be used in backpack applications or mounted in vehicles or aircraft. OmniSTAR typically provides the user with the GPS receiver equipment and subscription service for an annual lease fee.

e. STARFIX-Plus augmentation service. Fugro's STARFIX-Plus differential GPS augmentation system utilizes dual-frequency receivers at reference stations to more accurately model ionospheric activity within a survey region. It has application in distant offshore areas.

f. OmniSTAR URL contact. For additional details on the OmniSTAR system, contact www.omnistar.com

9-12. LandStar Differential GPS Service (Thales)

LandStar-DGPS operates similarly to OmniSTAR described above. It likewise is a satellite delivered, "fee-for-service" commercial DGPS correction service providing 24-hour real-time precise positioning in over 40 countries. LandStar operates a series of reference stations throughout the world that support the company's 24 hour manned control centers. LandStar-DGPS broadcasts correction data to users via the L-Band satellites. The system operates on a common global standard allowing LandStar receivers (and those that are compatible) to operate on any of the LandStar networks worldwide. Corrections are derived from a wide-area network solution similar to that described for OmniSTAR. This allows real-time positioning accuracies of one meter or less to be achieved throughout the LandStar coverage areas. A broad range of data receivers may be leased from Thales or from third-party vendors. LandStar-DGPS

applications include survey and mapping, agriculture, natural resources, land management, utilities, pipeline transmission, engineering, land and air navigation and positioning. For additional information contact Thales LandStar at www.racal-landstar.com.

9-13. Code and Carrier Phase Wide Area Augmentation Services

A number of commercial subscription augmentation systems are now available that are designed to achieve sub-meter (and approaching decimeter) accuracy over wide areas by processing carrier phase observables. These systems have application in Corps navigation projects where real-time, decimeter-level vertical accuracy is required--e.g., water surface elevation measurement. These systems operate like the wide-area code systems described above, but are functionally similar to RTK systems. They involve multiple reference stations surrounding a project area, and adjust correctors at a central server to best model the remote receiver's location. The main difference is that more accurate phase measurements are observed at the reference stations and remote receiver, resulting in a more accurate real-time position. Fugro's STARFIX-HP (High Performance) service claims a short real-time initialization period and 10 to 20 centimeter accuracy a few hundred km from the reference station network. It is designed for a variety of offshore survey and geophysical applications, including dredging control. The Trimble Virtual Reference Station (VRS) operates similarly to the Fugro STARFIX-HP. It uses a cellular phone network to communicate between reference receivers and roving receivers. Code and carrier phase data from a network of fixed reference stations are processed in a central server where quality checks are performed, cycle slips are detected, and double difference solutions are computed. The central server communicates with the remote user in order to model the location of the rover. Final corrector data are then transmitted by cellular modem to the rover. Claimed accuracies for the VRS are at the centimeter-level for local topographic applications. A primary advantage of all these systems is redundancy achieved from using multiple reference stations to model the user's position, as opposed to having only a single reference station. Another advantage is the clear satellite or cellular communication link, as opposed to less reliable RF methods.

Section III: Conducting Differential GPS Carrier Phase Surveys

9-14. General

Differential (or relative) GPS carrier phase surveying is used to obtain the highest precision from GPS and has direct application to most USACE military construction and civil works engineering, topographic, photogrammetric, and construction surveying support functions.

a. Differential survey techniques. There are a variety of differential GPS surveying techniques used in the past or today. Some of the more common methods include:

- Static
- Kinematic
- Post-Processed Kinematic
- Pseudo-Kinematic
- Pseudo-Static
- Intermittent Static
- Stop and Go Kinematic
- Rapid Static Kinematic
- Fast Static Kinematic
- Continuous kinematic
- Real-Time Kinematic (RTK)
- Kinematic Ambiguity Resolution
- "On-the-Fly" Initialized Real-Time Kinematic

Some of the above methods are identical or performed similarly, with minor differences depending on the GPS receiver manufacturer. Procedurally, all these methods are similar in that each measures a 3-D baseline vector between a receiver at one point (usually of known local project coordinates) and a second receiver at another point, resulting in a vector difference between the two points occupied. The major distinction between static and kinematic baseline measurements involves the method by which the carrier wave integer cycle ambiguities are resolved; otherwise they are functionally the same process. General procedures for performing some of these methods are described in this section. However, manufacturer's recommended survey methods should be followed for conducting any GPS field survey.

b. Carrier phase data reduction. Most carrier phase surveying techniques, except OTF real-time kinematic (RTK) techniques, require post-processing of the observed data to determine the relative baseline vector differences. Post-processing of observed satellite data involves the differencing of signal phase measurements recorded by the receiver. The differencing process reduces biases in the receiver and satellite oscillators. It is also strongly recommended that all baseline reductions be performed in the field, if possible, in order to allow an on-site assessment of the survey adequacy.

9-15. Ambiguity Resolution

Cycle ambiguity is the unknown number of whole carrier wavelengths between the satellite and receiver, as was described in Chapter 5. Successful ambiguity resolution is required for baseline formulations. Generally, in static surveying, ambiguity resolution can be achieved through long-term averaging and simple geometrical calibration principles, resulting in solutions to a linear equation that produces a resultant position. Thus, 30 minutes or more of observations may be required to resolve the ambiguities in static surveys. A variety of physical and mathematical techniques have been developed to rapidly

resolve the carrier phase ambiguities. The physical methods involve observations over known length baselines or equivalent known points. The most reliable method is to set the base and remote receivers up over known WGS 84 points, and collect data for at least 30 seconds. Initialization can also be accomplished over extremely short baselines, such as those shown in Figure 9-13. Another method that was more commonly used in the past was a reference-rover antenna swapping process. Most GPS systems today can automatically resolve ambiguities mathematically "on-the-fly" (OTF)--the technique used for many real-time kinematic (RTK) applications.

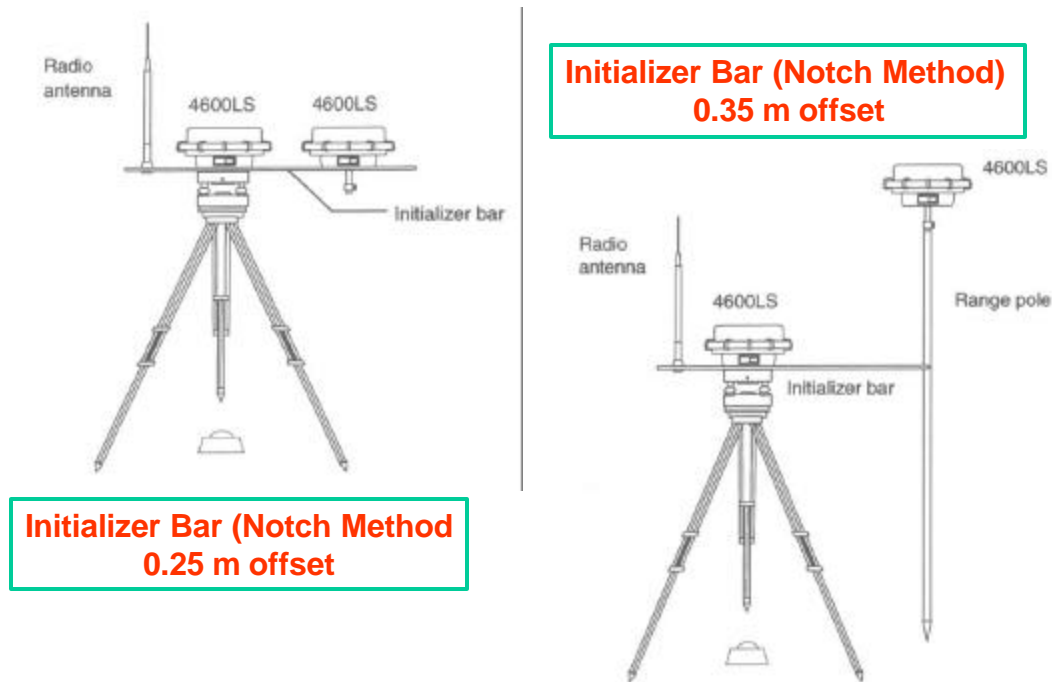

Figure 9-13. Ambiguity resolution of a Trimble 4600LS receiver using an Initializer Bar (Trimble Navigation, LTD)

9-16. Static Carrier Phase Field Survey Techniques

Static GPS surveying is perhaps the most common method of densifying project network control. Two GPS receivers are used to measure a GPS baseline distance. The line between a pair of GPS receivers from which simultaneous GPS data have been collected and processed is a vector referred to as a baseline. The station coordinate differences are calculated in terms of a 3-D, earth-centered coordinate system that utilizes X-, Y-, and Z-values based on the WGS 84 geocentric ellipsoid model. These coordinate differences are then subsequently shifted to fit the local project coordinate system.

a. General. GPS receiver pairs are set up over stations of either known or unknown location. Typically, one of the receivers is positioned over a point whose coordinates are known (or have been carried forward as on a traverse), and the second is positioned over another point whose coordinates are unknown, but are desired. Both GPS receivers must receive signals from the same four (or more)

satellites for a period of time that can range from a few minutes to several hours, depending on the conditions of observation and precision required. Guidance for planning static occupation times for horizontal and vertical control surveys is covered in Chapter 8.

b. Satellite visibility requirements. The stations that are selected for GPS survey observations should have an unobstructed view of the sky of at least 15 degrees or greater above the horizon during the "observation window." An observation window is the period of time when observable satellites are in the sky and the survey can be successfully conducted.

c. Common satellite observations. It is critical for a static survey baseline reduction/solution that the receivers simultaneously observe the same satellites during the same time interval. For instance, if receiver No. 1 observes a satellite set during the time interval 1000 to 1200 and another receiver, receiver No. 2, observes that same satellite set during the time interval 1100 to 1300, only the period of common observation, 1100 to 1200, can be processed to formulate a correct vector difference between these receivers.

d. Data post-processing. After the observation session has been completed, the received GPS signals from both receivers are then processed (i.e. "post-processed") in a computer to calculate the 3-D baseline vector components between the two observed points. From these vector distances, local or geodetic coordinates may be computed and/or adjusted. This baseline reduction process is explained in Chapter 10.

e. Survey configuration. Static baselines may be extended from existing control using any of the control densification methods described in Chapter 8. These include networking, traverse, spur techniques, or combinations thereof. Specific requirements are normally contained in project instructions (or scopes of work) provided by the District office.

f. Receiver operation and data reduction. Specific receiver operation and baseline data post-processing requirements are very manufacturer dependent. The user is strongly advised to consult and study manufacturer's operations manuals thoroughly along with the baseline data reduction examples shown in this manual.

9-17. Rapid/Fast Static Field Surveying Procedures

Rapid or Fast Static surveying is a form of static surveying techniques. The rover or remote receiver spends only a short time on each unknown point, loss of lock is allowed while the rover traverses between points, and accuracies are similar to those of static survey methods. Observed rapid static data are post-processed. Rapid static surveys are normally performed over small project areas. The rapid static technique does require the use of dual-frequency (L1/L2) GPS receivers with either cross correlation or squaring (or other techniques) to compensate for A/S.

a. Survey procedure. Rapid static surveying requires that one receiver be placed over a known control point. A rover or remote receiver occupies each unknown station for 5-30 minutes, depending on the number of satellites and their geometry. Because most receiver operations are manufacturer specific, following the manufacturer's guidelines and procedures for this type of survey is important.

b. Rapid static data processing. Data collected in the rapid static mode should be post-processed in accordance with the manufacturer's specifications and software procedures.

c. Accuracy of rapid static surveys. Accuracies of rapid static surveys are similar to static surveys of a centimeter or less. This method can be used for medium to high accuracy surveys up to 1/100,000.

d. Typical field observation instructions. The following instructions for Trimble 4000 series receivers are representative of rapid (fast) static field survey observations. These procedures are used at the Corps' PROSPECT training course in Huntsville, AL.

**Field Instructions on "FAST STATIC" GPS Data Collection
Survey IV PROSPECT Course**

- 1 – Turn receiver on.
 - 2 – After receiver boots-up, select MORE option using side keys (above **POWER** key)
 - 3 – Select SETUP SURVEY CONTROLS
 - 3a – select MODIFY FAST STATIC CONTROLS
 - 3b – set elevation mask to 15 degrees
 - 3c – set minimum meas times to 5 min for each
 - 3d – set meas sync time to 10 sec
 - 3e – select accept using side keys
 - 4 – Press **STATUS** key to check # of satellites
 - 5 – Press **LOG DATA** key
 - 6 – Select START FAST STATIC OR KINEMATIC SURVEY using side keys
 - 7 – Select START FAST STATIC SURVEY using side keys
 - 8 – Once antenna is set-up and plumbed over point, select START using side keys
 - 9 – Enter mark id using key pad and side keys (usually first four letters of the station name) and press **ENTER** key
 - 10 – Select INPUT/CHNGS from side keys
 - 10a – select CHANGES using side keys
 - 10b – select ANTENNA HEIGHT using side keys
 - 10c – enter antenna height (if fixed height pole is being used at the reference and remote, enter 2.069 meters and select MEAS TYPE as **true vertical**) and press **ACCEPT** using side keys
 - 10d – select FILE NAME using side keys
 - 10e – enter file name (i.e. ROV1 or COE1...) and make sure session # is correct, (last # in file name) and select **ACCEPT**. (This is only done once during a survey at both the reference and remote stations)
 - 10f – press **CLEAR** or **LOG DATA** key to get back to fast static menu
 - 11 – **If at reference station, nothing needs to be done**, read a good book until rover unit returns. You might however, press the **STATUS** key and then press MORE twice (using the side keys) to make sure data is being logged. Pressing the **LOG DATA** button will return you to the fast static menu.
 - 12 – **If at rover station**, fill out field form, wait until the screen time is 0 and says press MOVE before moving. (**do not disconnect power or turn receiver off when moving**)
 - 12a – press MOVE using the side keys
 - 12b – now move to next mark, satellite lock does not have to be maintained in-between stations
 - 12c – once plumb at next mark, press START
 - 12d – enter new mark id (just change 1st 4 characters) and press **ENTER** key.Repeat step 12 until finished with survey.
 - 13 – Pressing the **STATUS** key will give you UTC time. Then, pressing MORE twice (using the side keys) will show if data is being logged on each satellite. Pressing the **LOG DATA** button will return you to the fast static menu.
 - 14 – Once finished with survey, select END SURVEY using side keys, select YES and check antenna height and accept if correct.
 - 15 – To turn off, hold **POWER** key in until screen goes out.
-

9-18. Kinematic GPS Field Survey Techniques

Kinematic surveying using differential carrier phase tracking is similar to static carrier phase methods because it also requires two receivers recording observations simultaneously. The reference receiver remains fixed on a known control point while the roving receiver collects data on a constantly moving platform (vehicle, vessel, aircraft, manpack, etc.), as illustrated in Figure 9-14. The observation data is later post-processed to calculate relative vector/coordinate differences to the roving receiver. A kinematic survey requires, at minimum, two GPS receivers. One receiver is set over a known point (reference station) and the other is used as a rover (i.e. moved from point to point or along a path). Before the rover receiver can collect positional data at an unknown point, a period of static initialization may be required. (Alternatively, an OTF initialization technique may be used, as described below). This period of initialization is dependent on the number of visible satellites. Once initialization is completed, the rover receiver can move from point to point as long as satellite lock is maintained. If loss of satellite lock occurs, a new period of static initialization may be required. Some of the field techniques for the more common types of kinematic GPS surveying are described below. More detailed field procedures are found in operator's manuals provided by the GPS receiver manufacturer.

CARRIER-PHASE KINEMATIC POSITIONING

- Based on Carrier Phase Observations
- Positions Determined With Respect to the Fixed (Known) Station
- Traditional methods requires static initialization, OTF RTK does not
- No Intermediate Stops Required for Moving Receiver
- Either Real-Time or Post-mission Processing Possible

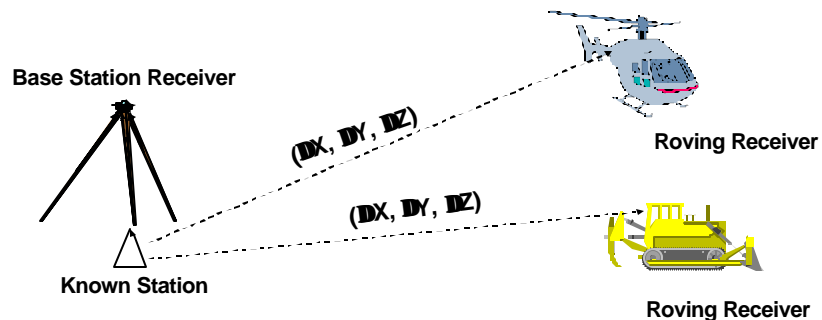

Figure 9-14. Kinematic survey techniques

9-19. Stop-and-Go Kinematic Field Survey Techniques

Differential GPS surveying known as "stop-and-go" is typically used for setting accurate topographic mapping or construction control points. It is similar to static surveying methods in that each method requires at least two receivers simultaneously recording observations. Unlike static methods, an initial calibration process is required prior to conducting the survey. A major difference between static and stop-and-go surveying is the amount of time required for a roving receiver to stay fixed over a point of

unknown position. In stop-and-go surveying, the first receiver--the base station or reference receiver--remains fixed on a known control point. The second receiver--the "rover" receiver--collects observations statically on a point of unknown position for a period of time (usually a few minutes), and then moves to subsequent unknown points to collect data for a short period of time. During the survey, at least four common satellites (preferably five) need to be continuously tracked by both receivers. Once the rover receiver has occupied all required points, the observations are then post-processed to calculate baseline vector/coordinate differences between the known control point and points occupied by the rover receiver during the survey session. The main advantage of this form of GPS surveying over static surveying is the reduced occupation time required over the unknown points. Stop-and-go kinematic surveying requires less occupation time over unknown points than static methods. Therefore, time and cost for the conduct of a survey are significantly reduced. Achievable accuracies typically equal or exceed 10 mm.

a. Survey procedure. Stop-and-go surveying is performed similarly to a conventional electronic total station radial survey. The system is initially calibrated by performing either an antenna swap with one known point and one unknown point, by performing a static measurement over a known baseline, or by observing static data at another known point on the network. This calibration process is performed to resolve carrier phase cycle ambiguities. A known baseline may be part of the existing network or can be established using static GPS survey procedures described above. The roving receiver then traverses between unknown points as if performing a radial topographic survey. Typically, the points are double-connected, or double-run, as in a level line. Optionally, two fixed receivers may be used to provide redundancy on the remote points. With only a few minutes of data collection at a point, topographic X-Y-Z coordinate production is high.

b. Satellite lock. During a stop-and-go survey, the rover receiver must maintain lock on at least 4 satellites during the period of survey. The reference station must also be observing at least the same 4 satellites. Loss of lock occurs when the receiver is unable to continuously record satellite signals or the transmitted satellite signal is disrupted and the receiver is not able to record it. If satellite lock is lost, the roving receiver must reobserve the last fixed point surveyed before loss of lock. The operator must closely monitor the GPS receiver when performing the stop-and-go survey to ensure loss of lock does not occur. Some manufacturers have now incorporated an alarm into their receiver that warns the user when loss of lock occurs, thus making the operator's job of monitoring the receiver easier.

c. Site constraints. Survey site selection and the route between points to be surveyed are critical. All observing points must have a clear view of satellites having a vertical angle of 15 degrees or greater. The routes between rover occupation points must be clear of obstructions so that the satellite signal is not interrupted. Each unknown station to be occupied should be observed for a minimum of at least 90 seconds. Remote points should be occupied two or three times to provide redundancy between observations.

d. Antenna swap calibration procedure. The antenna swap initialization procedure requires that two nearby points be occupied and that both points maintain an unobstructed view of the horizon. A minimum of four satellites and constant lock are required; however, more than four satellites are preferred. To perform an antenna swap, one receiver/antenna is placed over a point of known control and the second, a distance of 10 to 100 m away from the other receiver. The receivers at each station collect data for approximately 2 to 4 minutes. The receivers/antennae sets then swap locations: the receiver/antenna at the known station is moved to the unknown site while the other receiver/antenna at the unknown site is moved to the known site. Satellite data are again collected for 2 to 4 minutes. The receivers are then swapped back to their original locations. This completes one antenna swap calibration. If satellite lock is lost during the process, the calibration procedure must be repeated. The baseline data are processed to determine and eliminate the carrier integer ambiguity. Although an antenna swap

procedure is used to initialize a stop-and-go survey, the same technique can also be used to determine a precise baseline and azimuth between two points.

e. Accuracy of stop-and-go surveys. Accuracy of stop-and-go baseline measurements will well exceed 1 part in 5,000; thus, supplemental project/mapping horizontal control can be established using this technique. For many USACE projects, this order of horizontal accuracy will be more than adequate; however, field procedures should be designed to provide adequate redundancy for what are basically "open-ended" or "spur" points. Good satellite geometry and minimum multipath are also essential in performing acceptable stop-and-go surveys.

9-20. Pseudo-Kinematic Field Survey Techniques

Pseudo-kinematic GPS surveying is similar to stop-and-go kinematic techniques except that loss of satellite lock is tolerated when the receiver is transported between occupation sites (in fact, the roving receiver can be turned off during movement between occupation sites, although this is not recommended). This feature provides the surveyor with a more favorable positioning technique since obstructions such as bridge overpasses, tall buildings, and overhanging vegetation are common. Loss of lock that may result due to these obstructions is more tolerable when pseudo-kinematic techniques are employed.

a. General. The pseudo-kinematic technique requires that one receiver be placed over a known control station. A rover receiver occupies each unknown point or monument for 5-10 minutes. Approximately 1 hour (but not longer than 4 hours) after the initial occupation, the same rover receiver must reoccupy each unknown point.

b. Common satellite requirements. The pseudo-kinematic technique requires that at least four of the same satellites be observed between initial unknown point occupations and the requisite reoccupations. For example, the rover receiver occupies Station A for the first 5 minutes and tracks satellites 6, 9, 11, 12, 13; then 1 hour later, during the second occupation of Station A, the rover receiver tracks satellites 2, 6, 8, 9, 19. In this example, only satellites 6 and 9 are common to the two sets, so the data cannot be processed because four common satellites were not tracked for the initial station occupation and the requisite reoccupation.

c. Planning. Prior mission planning is essential in conducting a successful pseudo-kinematic survey. Especially critical is the determination of whether or not common satellite coverage will be present for the desired period of the survey. Also, during the period of observation, one receiver, the base receiver, must continuously occupy a known control station.

d. Pseudo-kinematic data processing. Pseudo-kinematic survey satellite data records and resultant baseline processing methods are similar to those performed for static GPS surveys. Since the pseudo-kinematic technique requires each station to be occupied for 5 minutes and then reoccupied for 5 minutes approximately an hour later, this technique is not suitable when control stations are widely spaced and transportation between stations within the allotted time is impractical.

e. Accuracy of pseudo-kinematic surveys. Pseudo-kinematic survey accuracies are at the centimeter level.

9-21. Real-Time Kinematic (RTK) Field Surveying Techniques

Unlike the static and kinematic methods previously covered, RTK methods provide real-time positioning results. Real-time surveys are most useful for construction stakeout, setting project control, and topographic mapping. To obtain real-time coordinates, a communication link (radio or satellite) is required between the reference base station and the roving receiver. RTK surveying is similar to other kinematic GPS survey methods in that it requires two receivers simultaneously recording observations. Unlike other GPS methods, the rover receiver can be continuously moving. RTK surveys require dual-frequency (L1/L2) GPS observations. Periodic losses of satellite lock can also be tolerated. Since RTK uses the L2 frequency, the GPS receiver must be capable of tracking the L2 frequency during A/S. There are several techniques used to obtain L2 during A/S. These include squaring and cross correlation methods.



Figure 9-15. Real-Time kinematic survey reference and remote stations

a. Ambiguity resolution. As previously explained, carrier phase integer ambiguity resolution is required for successful baseline formulations. RTK surveys can be initialized using the methods previously described--e.g., at a known point. However, if the receiver is equipped with "on-the-fly" (OTF) initialization technology, then the remote can initialize and resolve integers without a period of static initialization. With OTF capability, if loss of satellite lock occurs, initialization can occur while in motion. OTF integers can usually be resolved at the rover within 10-30 seconds, depending on the distance from the reference station. This initialization is automatically performed by the survey controller device. OTF makes use of the L2 frequency in resolving the integer ambiguity. At least 5 satellites are required for OTF initialization, and after initialization, at least 4 satellites must be tracked. After the integers are resolved, only the L1 C/A is used compute the positions. If no OTF capability is available, then initialization should be made at a known point and 4 satellites must be kept in view at all times--loss of lock requires reinitialization.

b. Survey procedure. RTK/OTF surveying requires dual-frequency L1/L2 GPS receivers. One of the GPS receivers is set over a known point and the other is placed on a moving or roving platform. The survey controller will determine the amount of time required to lock in over each remote point. If the survey is performed in real-time, a data link and a processor (external or internal) are needed. The data link is used to transfer the raw data from the reference station to the remote. If the radio link is lost, then post-processing techniques are available to compute the survey--e.g., Trimble's "Infill" option.

c. Accuracy of RTK surveys. RTK surveys are accurate to within 3-10 cm (in 3-D) when the distance from the reference to the rover does not exceed 10 k.

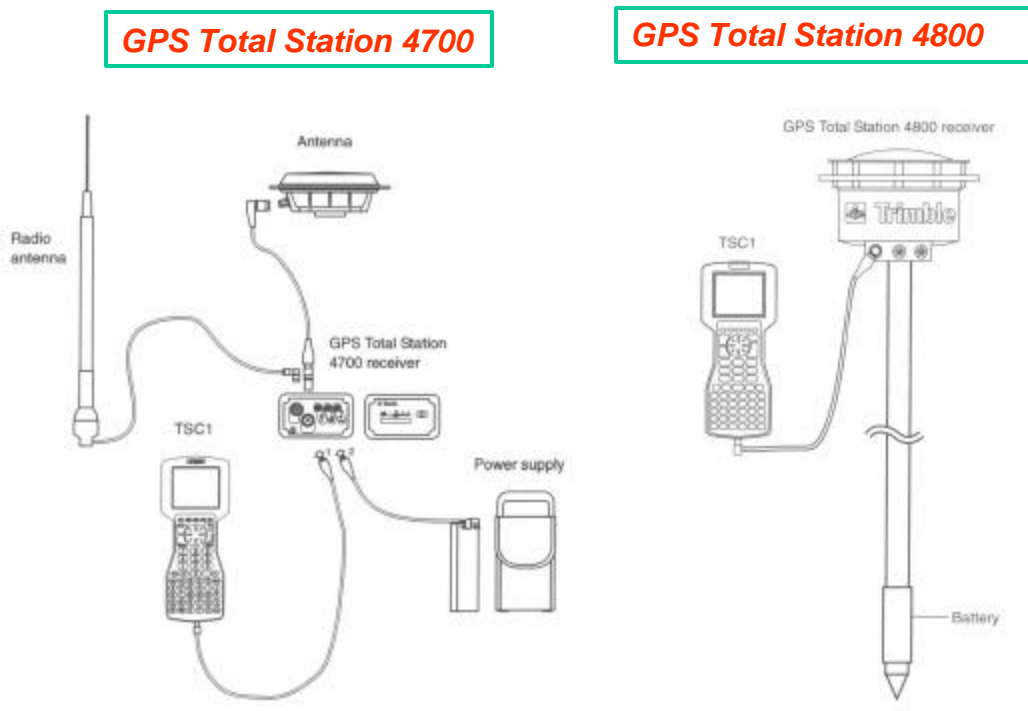

Figure 9-16. Rover GPS receiver setup for RTK surveys--Trimble GPS Total Station 4700 and Trimble GPS Total Station 4800. (Trimble Navigation LTD)

9-22. RTK Survey Field Procedures and Calibrations

The USFS and BLM *Standards and Guidelines for Cadastral Surveys* (USFS/BLM 2001) contains guidance for performing RTK surveys that is directly applicable to USACE RTK topographic mapping and construction control surveys. Some of the more significant field procedures recommended by the USFS/BLM are outlined below. These generally reduce down to (1) system checks, (2) measurement procedures, (3) and calibrations.

a. RTK system check. A RTK system check shall be made prior to any measurements. RTK system checks may also be made at any time during the course of each RTK survey session or at any time the base receiver(s) and rover receiver(s) are set up and initialized per the manufacturer's recommended procedures. This check is a measurement from the RTK base setup to another known project control monument. The resulting observed position is then compared by inverse to the previously observed position for the known point. This inverse should be within the manufacturer's recommended values for duplicate point tolerance measurements--typically within ± 2.5 cm in position and within ± 5 cm in elevation. This RTK system check is designed to check the following system parameters:

- The correct reference base station is occupied.
- The GPS antenna height is correctly measured and entered at the base and rover.
- The receiver antennas are plumb over station at base and rover.
- The base coordinates are in the correct datum and plane projections are correct.
- The reference base stations or the remote stations have not been disturbed.
- The radio-communication link is working.
- The RTK system is initialized correctly.
- RMS values are within manufacturer's limits.

b. RTK measurements. RTK topographic observations are usually made using one or more base stations and one or more rover receivers. RTK measurements shall be made after the system setup check procedures have been completed. Use manufacturer's recommended observation times for the highest level of accuracy when setting mapping or construction control points, for example, 180 seconds of time or when the horizontal (e.g., 2 cm) and vertical (e.g., 5 cm) precision has been met for a kinematic control point. Under optimal conditions a deviation from the manufacturer's suggested time is appropriate; for example, a point may be observed using 30 seconds of time and 20 epochs of measurement data. However, observation times should be set to account for field conditions, measurement methods (i.e. Trimble "topo point" or "kinematic control point") and the type of measurement checks being performed.

c. Recommended methods for setting control points using RTK. One method is to observe the unknown point two or more times with the same point name (e.g., 100700) and use a duplicate point tolerance measurement criteria of 2.5 cm. When observing these measurements, the antenna shall be inverted and the receiver reinitialized between observations. Another method is to observe two separate baselines (M1 and M2) to the unknown point. The baseline data are stored to the data collector or receiver for a specified number of seconds or epochs to meet a specified level of precision recommended by the manufacturer for a kinematic control point. Observation time may be increased due to the constraints of on-the-fly (OTF) post-processing kinematic (i.e. 200+ sec) if the field data is post-processed as a check. Between the M1 and M2 baseline measurements the antenna should be inverted to force a loss of satellite lock, which forces the system to reinitialize. The point values resulting from the first baseline measurement are stored and labeled (e.g., 100700M1), and the point values resulting from the second baseline measurement are stored and labeled (e.g., 100700M2). A field check of the level of

accuracy between the measurements may be done by an inverse between M1 and M2. The resulting inverse distances should agree within 2.5 cm.

d. Typical field observation instructions. The following instructions for Trimble 4000 series receivers are representative of RTK/OTF static field survey observations. These procedures are used at the Corps' PROSPECT training course in Huntsville, AL (see also Figure 9-17).

Instructions on "Real-Time Kinematic" GPS Data Collection

- 1 – Turn receiver on
 - 2 – While receiver boots-up, you may need to select **CLEAR** key
 - 3 – Press **CONTROL** key
 - 3a – select Rover Control
Enable L1/L2 and press ENTER
 - 3b – select Power Control
select Power output ENABLED and press ENTER
 - 4 – Press **STATUS** key to check # of satellites
 - 4a – select **POSITION** to check for (RTK-moving/Fix/L1)
- Move to first occupation station
- 5 – Press **LOG DATA** key
 - 6 – Select START FAST STATIC OR KINEMATIC SURVEY using side keys
 - 7 – Select START KINEMATIC SURVEY using side keys
 - 8 – Once antenna is set-up and plumbed over point
 - 8a – enter POINT ID using keypad and side keys

MH	for Manhole
LP	for Lightpole
DG	for Drainage Grate
SE	for Spot elevation
TC	for Top of Curb
BEVX	for BEV check point (X=1-6)
COEX	for COE check point (X=1-3)
 - 8b – to set or change HI or FILENAME, Select **INPUT/CHNGS** from side keys
 - 8b1 – select **CHANGES** using side keys
for antenna height, select **ANTENNA HEIGHT** using side keys
check/enter antenna height and MEAS TYPE and then press
ACCEPT and then CLEAR

For filename, select **FILENAME** using side keys
Enter filename (ONLY need to change this ONCE for entire
session) and then press ACCEPT and then CLEAR
 - 8c – select STATIC using side keys
 - 8d – observe STATIC WAIT until ROVE appears in upper right
 - 8e – wait until EPOCHS reaches 10 and then press ROVE
 - 8f – move to next occupation station
 - 9 – Repeat step 8 until done collecting occupations
 - 10 – When completed, press **LOG DATA**
 - 10a – select **END SURVEY** using side keys, select YES and check antenna height
and press ACCEPT
 - 11 – To turn off, hold **POWER** key in until screen goes out.
-



Figure 9-17. RTK positioning of drainage basin at Huntsville, AL Tom Beville Center (PROSPECT GPS Training Course--2002)

Chapter 10 Post-Processing Differential GPS Observational Data

10-1. General

GPS baseline solutions are usually generated through an iterative process. From approximate values of the positions occupied and observation data, theoretical values for the observation period are developed. Observed values are compared to computed values, and an improved set of positions occupied is obtained using least-squares minimization procedures and equations modeling potential error sources. Observed baseline data are also evaluated over a loop or network of baselines to ascertain the reliability of the individual baselines. A generalized flow of the processes used in reducing GPS baselines is outlined below. This chapter will cover the steps outlined in this process.

- Create New Project File Area
- Download/Import Baseline Data from Receivers or Survey Data Collectors
- Download Precise Ephemeris Data if Required
- Make Changes and Edits to Raw Baseline Data
- Process all Baselines
- Review, Inspect, and Evaluate Adequacy of Baseline Reduction Results
- Make Changes and Rejects
- Reprocess Baselines and Reevaluate Results
- Note/Designate Independent and Trivial Baselines
- [Review Loop Closures and Adjust Baseline Network--Chapter 11]

a. The ability to determine positions using GPS is dependent on the effectiveness of the user to determine the range or distance of the satellite from the receiver located on the earth. There are two general techniques currently operational to determine this range: differential code pseudorange and differential carrier phase measurement. This chapter will discuss general post-processing issues for differential carrier phase reductions that provide centimeter-level accuracy suitable for controlling project monuments. Post-processed differential code phase reductions, with accuracies ranging from 0.2 to 5 meters, are only briefly covered since these techniques are not intended for precise control surveys.

b. Baseline processing time is dependent on the required accuracy, processing software, computer hardware speeds, data quality, and amount of data collected. The user must take special care when processing baselines with observations from different GPS receiver manufacturers. It is important to ensure that observables being used for the formulation of the baseline are of a common format (i.e. RINEX).

10-2. General Differential Reduction Techniques

Differential reduction techniques basically involve the analysis of the Doppler frequency shifts that occur between the moving satellites and ground-based receivers, one of which may be in motion (e.g., RTK rover). Integration of the Doppler frequency offsets, along with interferometric processing and differencing techniques, provides for a resultant baseline vector between the two ground-based points, or velocity measurements on a moving receiver. Differencing and interferometric analysis techniques may be performed on both carrier frequencies (L1 & L2), the frequency difference (wide-laning), and on the code-phase observations. "Floating" and "Fixed" baseline solutions are computed from these interferometric differencing techniques. A variety of algorithms and methods are used to perform the reductions. Although these processes are relatively simple for static GPS observations, they become

complicated when real-time (on-the-fly) integer ambiguity resolution is required. A variety of GPS data reduction software can be obtained from government agencies or commercial vendors. The detailed theory and derivations of these reductions are beyond the scope of this manual. The material presented in the following sections should be considered as only an overview. Examples of baseline reduction software will be limited to those software packages commonly used by Corps commands. Full discussions on carrier phase reductions can be found in the references listed in Appendix A. Kaplan 1996 (Chapter 8--Differential GPS) is recommended along with Leick 1995, and Remondi 1985.

10-3. Carrier Phase Observables

The carrier "beat" phase observable is the phase of the signal remaining after the internal oscillated frequency generated in the receiver is differenced from the incoming carrier signal of the satellite. The carrier phase observable can be calculated from the incoming signal or from observations recorded during a GPS survey. By differencing the signal over a period or epoch of time, one can count the number of wavelengths that cycle through the receiver during any given specific duration of time. The unknown number of cycles between the satellite and receiver antenna is known as the "integer cycle ambiguity." There is one integer ambiguity value per each satellite/receiver pair as long as the receiver maintains continuous phase lock during the observation period. The value found by measuring the number of cycles going through a receiver during a specific time, when given the definition of the transmitted signal in terms of cycles per second, can be used to develop a time measurement for transmission of the signal. Once again, the time of transmission of the signal can be multiplied by the speed of light to yield an approximation of the range between the satellite and receiver. The biases for carrier phase measurement are the same as for pseudoranges, although a higher accuracy can be obtained using the carrier phase. A more exact range between the satellite and receiver can be formulated when the biases are taken into account during derivation of the approximate range between the satellite and receiver.

10-4. Baseline Solution by Linear Combination

The accuracy achievable by pseudoranging and carrier phase measurement in both absolute and relative positioning surveys can be improved through processing that incorporates differencing of the mathematical models of the observables. Processing by differencing takes advantage of correlation of error (e.g., GPS signal, satellite ephemeris, receiver clock, and atmospheric propagation errors) between receivers, satellites, and epochs, or combinations thereof, in order to improve GPS processing. Through differencing, the effects of the errors that are common to the observations being processed are eliminated or at least greatly reduced. Basically, there are three broad processing techniques that incorporate differencing: single differencing, double differencing, and triple differencing. Differenced solutions generally proceed in the following order: differencing between receivers takes place first, between satellites second, and between epochs third (Figure 10-1).

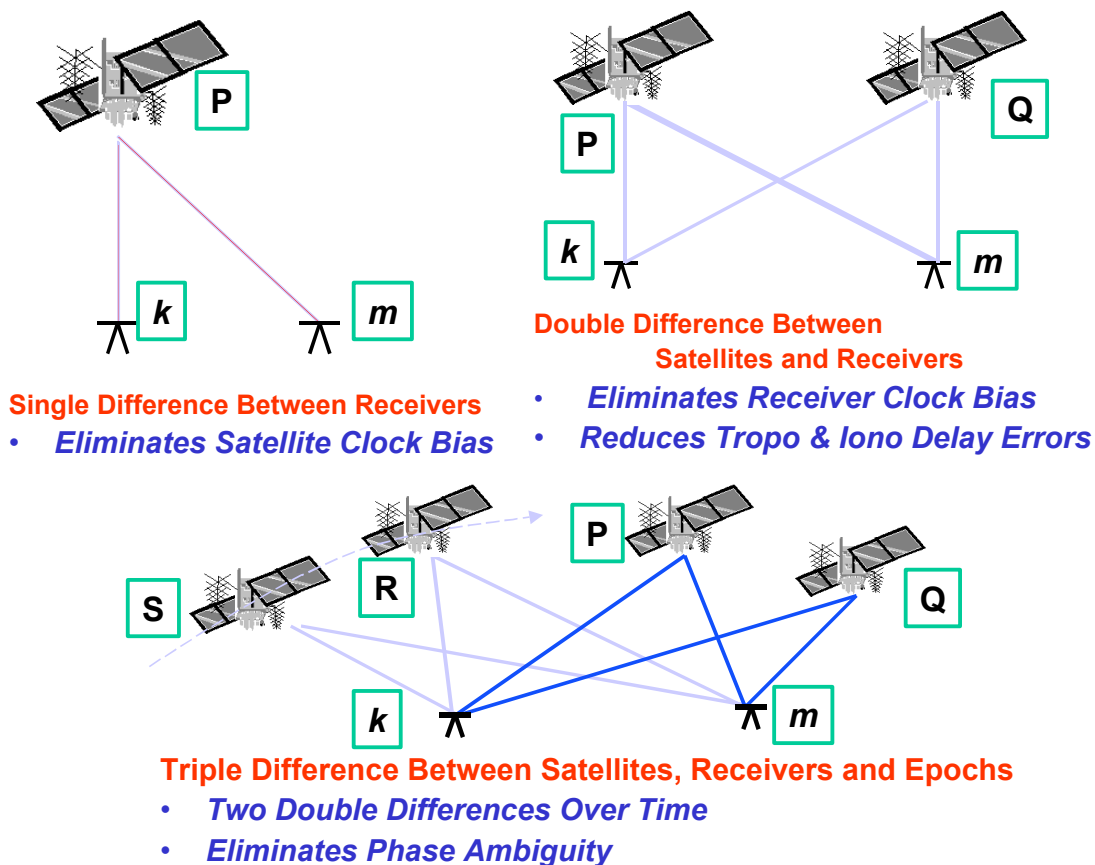

Figure 10-1. Carrier phase differencing techniques

a. *Single differencing.* There are three general single differencing processing techniques: between receivers, between satellites, and between epochs.

(1) Between receivers. Single differencing the mathematical models for a pseudorange (P- or C/A-code) or carrier phase observable measurements between receivers will eliminate or greatly reduce satellite clock errors and a large amount of satellite orbit and atmospheric delays. This is illustrated in upper left portion of Figure 10-1 where single differences are computed between the two receivers (k and m) and the satellite "P."

(2) Between satellites. Single differencing the mathematical models for pseudorange code or carrier phase observable measurements between satellites eliminates receiver clock errors. Single differencing between satellites can be done at each individual receiver during observations as a precursor to double differencing and in order to eliminate receiver clock errors.

(3) Between epochs. Single differencing the mathematical models between epochs takes advantage of the Doppler shift or apparent change in the frequency of the satellite signal by the relative motion of the transmitter and receiver. Single differencing between epochs is generally done in an effort to eliminate cycle ambiguities. There are three forms of single differencing techniques between epochs: Intermittently Integrated Doppler (IID), Consecutive Doppler Counts (CDC), and Continuously Integrated Doppler (CID). IID uses a technique whereby Doppler count is recorded for a small portion of

the observation period, the Doppler count is reset to zero, and then at a later time the Doppler count is restarted during the observation period. CDC uses a technique whereby Doppler count is recorded for a small portion of the observation period, reset to zero, and then restarted immediately and continued throughout the observation period.

b. Double differencing. Double differencing is actually a differencing of two single differences (as detailed above). There are two general double differencing processing techniques: receiver-time and receiver-satellite. Double difference processing techniques eliminate clock errors.

(1) Receiver-time double differencing. This technique uses a change from one epoch to the next, in the between-receiver single differences for the same satellite. Using this technique eliminates satellite-dependent integer cycle ambiguities and simplifies editing of cycle slips.

(2) Receiver-satellite double differencing. There are two different techniques that can be used to compute a receiver-satellite double difference. One technique involves using two between-receiver single differences, as shown in the upper right of Figure 10-1. This technique also uses a pair of receivers, recording different satellite observations during a survey session and then differencing the observations between two satellites. The second technique involves using two between-satellite single differences. This technique also uses a pair of satellites, but different receivers, and then differences the satellite observations between the two receivers.

c. Triple differencing. There is only one triple differencing processing technique: receiver-satellite-time (epoch). All errors eliminated during single- and double-differencing processing are also eliminated during triple differencing. When used in conjunction with carrier beat phase measurements, triple differencing eliminates initial cycle ambiguity. During triple differencing, the data is also automatically edited by the software to delete any data that cannot be solved, so that the unresolved data are ignored during the triple difference solution. This feature is advantageous to the user because of the reduction in the editing of data required; however, degradation of the solution may occur if too much of the data is eliminated during triple differencing.

d. Differencing equations. The expressions for single differences between receivers and satellites can be formed from the general carrier phase observable given back in Chapter 5 as Equation 5-2 (Kaplan 1996), which is repeated below. Refer also to Figure 10-1.

$$\mathbf{f}_k^P(t) = \mathbf{f}_k^P(t) - \mathbf{f}^P(t) + N_k^P + S_k + \frac{1}{f} \mathbf{t}_P + \frac{1}{f} \mathbf{t}_k - \mathbf{b}_{\text{iono}} + \mathbf{d}_{\text{tropo}} \quad (\text{Eq 10-1})$$

where

- $\mathbf{f}_k^P(t)$ = length of propagation path between satellite "P" and receiver "k" ... in cycles
- $\mathbf{f}_k^P(t)$ = received phase of satellite "P" at receiver "k" at time "t"
- $\mathbf{f}^P(t)$ = transmitted phase of satellite "P"
- N_k^P = integer ambiguity
- S_k = measurement noise (multipath, GPS receiver, etc.)
- $\frac{1}{f}$ = carrier frequency (Hz)
- \mathbf{t}_P = satellite clock bias
- \mathbf{t}_k = receiver clock bias
- \mathbf{b}_{iono} = ionospheric advance (cycles)
- $\mathbf{d}_{\text{tropo}}$ = tropospheric delay (cycles)

For a second receiver "m" another equation can be written for the propagation path between satellite "P" and the second receiver "m":

$$\mathbf{f}_m^P(t) = \mathbf{f}_m^P(t) - \mathbf{f}^P(t) + N_m^P + S_m + \lambda t_P + \lambda t_m - \mathbf{b}_{iono} + \mathbf{d}_{tropo} \quad (\text{Eq 10-2})$$

Differencing the propagation path lengths between the two receivers "k" and "m" to the satellite "P" (Equations 10-1 and 10-2) results in a "single difference between receivers."

$$\mathbf{SD}_{km}^P = \mathbf{f}_{km}^P + N_{km}^P + S_{km}^P + \lambda t_{km} \quad (\text{Eq 10-3})$$

When a second satellite "Q" is added, a "single difference between receivers" can be formed for the second satellite "Q":

$$\mathbf{SD}_{km}^Q = \mathbf{f}_{km}^Q + N_{km}^Q + S_{km}^Q + \lambda t_{km} \quad (\text{Eq 10-4})$$

The "single difference" equations 10-3 and 10-4 can be differenced between themselves, thus creating a "double difference" involving two separate receivers (*k* and *m*) and two separate satellites (*P* and *Q*).

$$\mathbf{DD}_{km}^{PQ} = \mathbf{f}_{km}^{PQ} + N_{km}^{PQ} + S_{km}^{PQ} \quad (\text{Eq 10-5})$$

It is seen in the above "double difference" equation that most of the original unknown terms have been eliminated by these differencing techniques, with only the integer ambiguity (*N*) and noise (*S*) remaining to be determined. Additional "double difference" equations can be written for the two receivers between other combinations of epochs of satellites in view, and these multiple double difference equations can be again differenced (i.e. Triple Differenced) to remove the integer ambiguity term N_{km}^{PQ} .

$$\mathbf{TD}_{km}^{PQ} = \mathbf{DD}_{km}^{PQ}(t+1) - \mathbf{DD}_{km}^{PQ}(t) \quad (\text{Eq 10-6})$$

where *t* and *t + 1* are successive epochs.

The results of the Triple Difference baseline solution can then be input back into the Double Difference equations in order to resolve, or "fix," the integers in the Double Difference solution. Fixing the integers in a Double Difference solution constrains the integer ambiguity *N* to a whole number of cycles, and is the preferred baseline solution--see Leick 1995.

10-5. Baseline Solution by Cycle Ambiguity Recovery

The resultant solution (baseline vector) produced when differenced carrier phase observations resolve the cycle ambiguity is called a "fixed" solution. The exact cycle ambiguity does not need to be known to produce a solution; if a range of cycle ambiguities is known, then a "float" solution can be formulated from the range of cycle ambiguities. A floating baseline solution is a least-squares fit that may be accurate to only a few integer wavelengths. It is always desirable to formulate a fixed solution. However, when the cycle ambiguities cannot be resolved, which sometimes occurs when a baseline distance is greater than 75 km in length, a float solution may actually be the best solution. Differences between floating and fixed solutions can be calculated over all the epochs observed. The fixed solution may be unable to determine the correct set of integers (i.e. "fix the integers") required for a solution.

10-6. Field/Office Baseline Processing

It is strongly recommended that baselines should be processed daily in the field. This allows the user to identify any problems that may exist. Once baselines are processed, the field surveyor should review each baseline output file. Certain computational items within the baseline output are common among software vendors, and may be used to evaluate the adequacy of the baseline observations in the field. Baseline outputs may include triple difference, float double difference, and fixed double difference distance vectors, variance and covariance statistics, and RMS accuracy estimates. The procedures used in baseline processing are software dependent; however, the output statistics and analysis of reliability are somewhat similar among different vendors. Discussion and examples in the following sections are largely taken from Trimble Geomatics Office software user guide manuals that are referenced in Appendix A.



Figure 10-2. Baseline processing (Huntsville, AL PROSPECT GPS Course--2002)

a. Baseline processing. Baseline processing software is now fairly automatic and user-friendly. Most software automatically performs all the interferometric differencing operations needed to solve for integer ambiguities, and displays the resultant baseline vectors along with adjustment and accuracy statistics that can be used to evaluate the results. The following procedures are taken from Trimble Navigation's "Weighted Ambiguity Vector Estimator" (WAVE) software (Trimble 2001d) and are believed to be representative of most packages. Trimble's WAVE baseline processor involves performing the following steps, in order:

1. Load raw GPS observation DAT files
2. Select the display options
3. Set the processing style & baseline flow sequence
4. Edit occupations (station names, antenna heights, etc.)
5. Import a coordinate seed (approximate point positions)
6. Choose baselines for processing (identify independent baselines)
7. Process the baselines
8. Review the results

Where multiple baselines are observed in a network, the software will process the baselines sequentially. Independent baselines should be identified during this phase. If a precise ephemeris is available, then it should be downloaded and input into the baseline reduction program. Complete details on performing each of these baseline processing steps is found in the *Trimble Geomatics Office--WAVE Baseline Processing Software User Guide* (Trimble 2001d).

b. Downloading GPS data. The first step in baseline processing is transferring the observation data from the GPS data collector device to a personal computer for processing and archiving. Various types of file formats may be involved, depending on the GPS receiver--e.g., Trimble Receiver *.DAT files, Trimble Survey Controller *.DC files, or RINEX ASCII files. Data adjustment software packages have standard downloading options for transferring GPS data files, or routines to convert proprietary GPS files to RINEX format. Trimble *.DAT files contain information on receiver type, antenna measurement method, antenna type, raw carrier phase observations, antenna height, satellite ephemeris, and station designation/name. RINEX files are also obtained for remote IGS tracking network stations or CORS base stations.

c. Preprocessing. Once observation data have been downloaded, preprocessing of data can be completed. Preprocessing procedures depend on the type of GPS data collected, e.g., static, RTK, Fast static, etc., and the type of initialization performed (static, known point, OTF, etc.). Preprocessing consists of smoothing/editing the data and ephemeris determination. Smoothing and editing are done to ensure data quantity and quality. Activities done during smoothing and editing include determination and elimination of cycle slips, editing gaps in information, and checking station names and antenna heights. In addition, elevation mask angles should be set during this phase along with options to select tropospheric and ionospheric models.

d. Ephemeris data. Retrieval of post-processed ephemerides may be required depending on the solution and type of survey being conducted. Code receivers do not require post-processed ephemerides since they automatically record the broadcast ephemerides during the survey. Most baseline reduction software provides an option to select either a broadcast or precise ephemeris.

e. Baseline solutions. Carrier phase baseline processing is fairly automatic on commercial software packages. Groups of baselines are processed in a defined or selected order. After an initial code solution is performed, a triple difference, then double-difference, solution is performed. If the integer ambiguities are successfully resolved, then a fixed solution can result. Solution types may include L1 Fixed, Ionospheric-Free Fixed, and Float. If all observed baselines are processed, any dependent baselines should be removed so they will not be used in subsequent network adjustments. Commercial baseline reduction software may have a variety of options that are automatically (or manually) set to determine the most "optimum" solution. Most software packages attempt to perform the most accurate fixed solution for short lines (e.g., less than 15 km for single-frequency and less than 30 km for dual-frequency receivers). The ability to derive an accurate fixed solution (i.e. 5 to 10 mm) will also depend on the length of time of noise-free data, good DOP, multipath, etc. For baselines longer than 30 to 50 km,

if the fixed solution is not deemed to be reliable (based on various quality indicators discussed below), then the default float solution may be used. Although not as accurate as the fixed solution, if the session time is long enough (e.g., 1 to 2 hours) the float solution will be fairly accurate--e.g., 20 to 50 mm for lines less than 75 km. Most processing software provides numerous statistical and graphical displays of baseline solution results, allowing users to assess the reliability of a particular solution, and force an alternate solution if necessary--see Figure 10-3 for a typical example.

10-7. Resultant Baseline Output and Quality Criteria

Baseline post-processing software outputs vary with the software package. Baseline output data are used to evaluate the quality of the solution, and may be input into subsequent network adjustment criteria. Typically, the following types of information may be selected for text output or graphical screen display:

- number of processed baselines (in network)
- number of accepted and rejected baselines
- session time (date, time)
- data logging time (start, stop)
- station information: location (latitude, longitude, height), receiver serial number used, antenna serial number used, ID numbers, antenna height
- epoch intervals
- number of epochs
- meteorological data (pressure, temperature, humidity)
- ephemeris file used for the solution formulation
- listing of the filenames
- elevation mask
- minimum number of satellites used
- type of satellite selection (manual or automatic)
- triple difference solution
- double difference fixed solution
- double difference float solution
- L1 only solution
- Ionospheric-free solution (L1 & L2)
- baseline vector length in meters
- RMS of solution
- Post-fit RMS by satellite vs. baseline
- RMS--L1 phase
- RMS-L1 Doppler
- RMS--P-code
- Cycle slips
- reference variance
- ratio of solution variances of integer ambiguity
- phase ambiguities & drifts
- phase residual plots--L1 & C/A
- satellite availability and tracks during the survey for each station occupied
- DOP, PDOP, VDOP, HDOP
- solution files: Δx - Δy - Δz between stations, slope distance between stations, Δ latitude and Δ longitude between stations, horizontal distance between stations, and Δ height
- covariance matrix

For most Corps applications, only a few of the above parameters need be output in order to assess the results and quality of a baseline solution. These parameters can best be assessed from graphical summary plots, as shown in Figure 10-3 below. Some more sophisticated reduction software, such as Waypoint Consulting's "GrafNav" and the NGS's "PAGES," provide considerably more statistical information than most other baseline processing packages; however, this level of GPS accuracy assessment is usually not applicable to most Corps engineering and construction control survey work. These detailed statistics may have application in assessing the quality of airborne GPS (ABGPS) applications. For more information on these high-level baseline reduction methods, see NGS 2000 (*PAGE-NT User's Manual*) and Waypoint 2001 (*GrafNav/GrafNet, GrafNav Lite, GrafMov Operating Manual*).

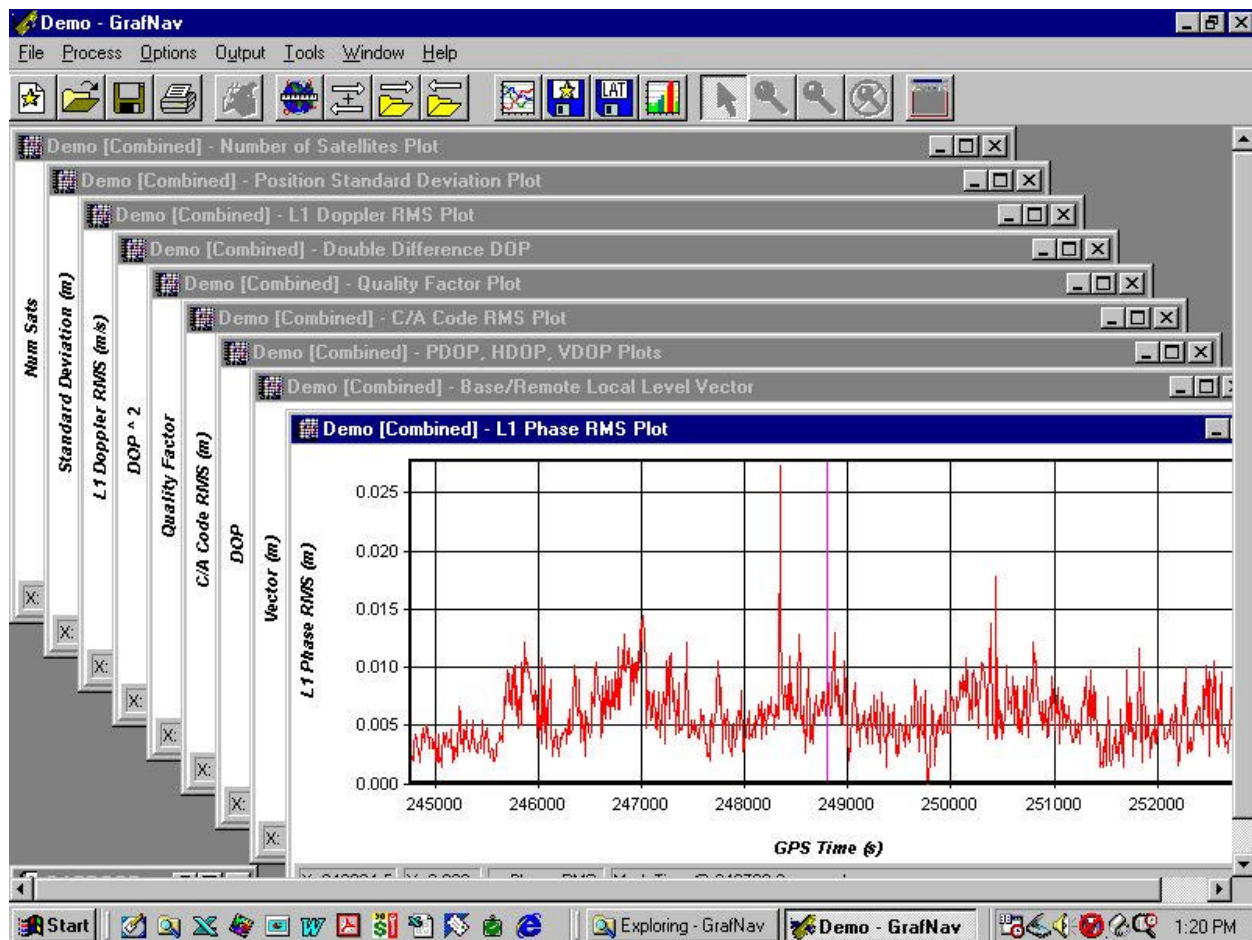

Figure 10-3. GrafNet baseline reduction output plots--some of the 28 selectable assessment options that may be plotted (Waypoint Consulting, Inc.)

a. *Variance Ratio--floating and fixed solutions.* A fixed solution indicates that the integer ambiguities have been successfully resolved. A floating solution may not have accurately resolved the integers; however, this may still be the best solution for that particular baseline observation. Trimble's WAVE solution computes the variances of each integer ambiguity solution and compares the solution with the lowest variance with the next higher variance solutions. This comparison "ratio" of the solutions should exceed 1.5 in order to accept the lowest variance as the fixed solution. If a variance ratio is less than 1.5 the processor defaults to the floating solution since there is no statistical basis for assuming a fixed solution has merit.

b. Reference variance. The reference variance indicates how well the computed errors in the solution compare with the estimated (*a priori*) errors for a typical baseline. A value of 1.0 indicates a good solution. Variances over 1.0 indicate the observed data were worse than the norm. Baselines with high reference variances and low variance ratios need to be checked for problems.

c. RMS. The RMS is a quality factor that helps the user determine which vector solution (triple, float, or fixed) to use in an adjustment. The RMS is dependent on the baseline length and the length of time the baseline was observed. RMS is a measurement (in units of cycles or meters) of the quality of the observation data collected during a point in time. RMS is dependent on line length, observation strength, ionosphere, troposphere, and multipath. In general, the longer the line and the more signal interference by other electronic gear, ionosphere, troposphere, and multipath, the higher the RMS will be. A good RMS factor (one that is low, e.g., between 0.01 and 0.2 cycles or less than 15 mm) may not always indicate good results, but is one indication to be taken into account. RMS can generally be used to judge the quality of the data used in the post-processing and the quality of the post-processed baseline vector.

d. Repeatability. Redundant lines should agree to the level of accuracy that GPS is capable of measuring to. For example, if GPS can measure a 10 km baseline to 1 cm + 1 ppm, the expected ratio of misclosure would be

$$(0.01 \text{ m} + 0.01\text{m}) / 10,000 = 1:500,000 \text{ (1 part in 500,000)}$$

Repeated baselines should be near the corresponding ratio: (1 cm + 1 ppm) / baseline. Table 10-1 shows an example computation of the agreement between two redundant GPS baselines.

Table 10-1. Sample Computation of GPS Baseline Repeatability

Baseline Observation Date	X	Y	Z	Distance
Day 203	5000.214	4000.000	7680.500	9999.611
Day 205	5000.215	4000.005	7680.491	9999.607
Difference	0.001	0.005	0.009	
Ratio = $(0.001^2 + 0.005^2 + 0.009^2)^{1/2} / 9999.6 = 0.010 / 9999.6$				= 1:967,000 [acceptable]

Table 10-2 below provides additional guidelines for determining the baseline quality if the fixed versus float solution is not readily assessed or available in the baseline processing software (i.e. Trimble variance ratio technique). If the fixed solution meets the criteria in this table, the fixed vector should be used in the adjustment. In some cases the vector passes the RMS test but after adjustment the vector does not fit into the network. If this occurs, the surveyor should try using the float vector in the adjustments or check to make sure stations were occupied correctly.

Table 10-2. Fixed Solution Acceptance Criteria

Distance Between Receivers (km)	RMS Criteria Formulation d = distance between receivers	Formulated RMS Range (cycles)	Formulated RMS Range (meters)
0 - 10	$\leq (0.02+(0.004*d))$	0.02 - 0.06	0.004 - 0.012
10 - 20	$\leq (0.03+(0.003*d))$	0.06 - 0.09	0.012 - 0.018
20 - 30	$\leq (0.04+(0.0025*d))$	0.09 - 0.115	0.018 - 0.023
30 - 40	$\leq (0.04+(0.0025*d))$	0.115 - 0.14	0.023 - 0.027
40 - 60	$\leq (0.08+(0.0015*d))$	0.14 - 0.17	0.027 - 0.032
60 - 100	≤ 0.17	0.17	0.032
> 100	≤ 0.20	0.20	0.04

Note:

1. These are only general post-processing criteria that may be superseded by GPS receiver/software manufacturer guidelines; consult those guidelines when appropriate.
2. For lines longer than 20 km, dual-frequency GPS receivers are recommended to meet these criteria.

e. Residual plots. Residual plots depict the data quality of the individual satellite signals. Typically the L1 phase residual error is plotted for all the satellites in view, or for as many that will fit on a computer screen. The plot is developed relative to the satellite chosen for double differencing. Variations about the x-axis are an indicator of noise for a particular satellite. If the satellite is used for double differencing, then no residual error will be shown for that period. Residual plots typically vary around ± 5 mm from the mean. Residual deviations exceeding ± 15 mm are suspect--see Table 10-3. A sample residual plot from a baseline solution is shown in Figure 10-4.

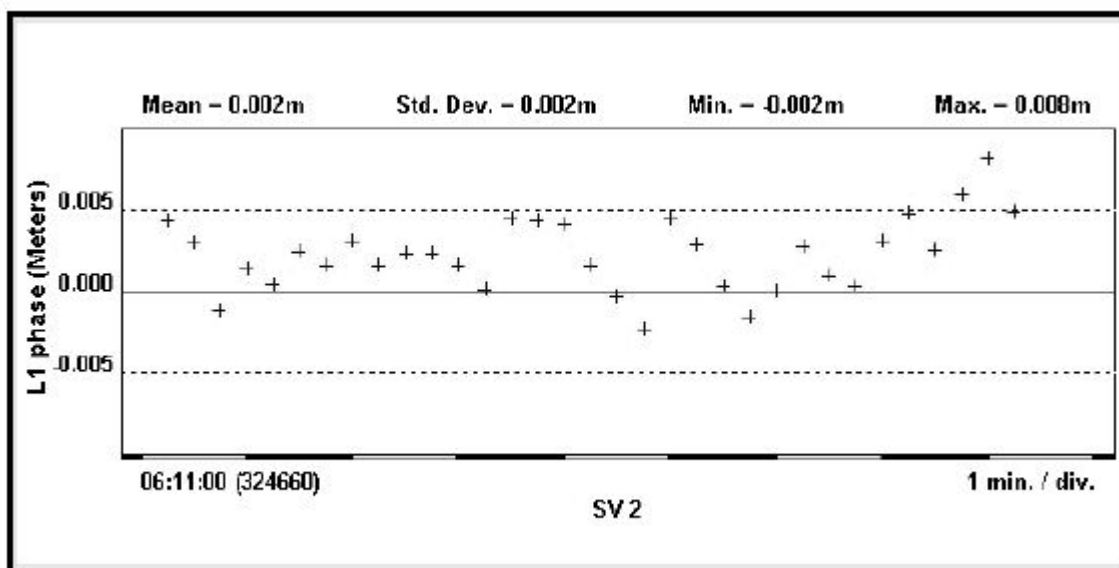

Figure 10-4. Sample residual plot (Trimble Navigation LTD WAVE baseline processing software)

f. Resolving poor baseline data. When baseline statistical data (e.g., reference variance and ratios, RMS, residual plots, etc.) does not meet the various quality checks outlined above, then a number

of options are available. These include removing some or all baselines in a session (if possible), changing the elevation mask, removing one or more satellites from the solution, or, if necessary, reobserving the baseline. Eliminating multipath problems is not as easy. It may show up on the residual plot as a sinusoidal wave over time. Multipath is best minimized by good site selection, choke ring antennas, and long session times.

g. Baseline acceptance criteria (Trimble). Trimble Geomatics Office software has three levels of acceptance to assist in evaluating the quality of a processed baseline. These acceptance levels are "Pass" (passes all criteria), "Flag" (one or more quality indicators are marginal but within acceptable tolerances), and "Fail" (one or more quality indicators do not meet acceptable criteria). The "quality indicators" used are: RMS, Reference Variance, and Variance Ratio. The quality indicator Pass/Flag/Fail levels may be modified from the default levels recommended by Trimble.

h. Table 10-3 below summarizes the quality control criteria discussed above that should be used in assessing the adequacy of a baseline reduction.

Table 10-3. Summary of Baseline Processing Quality Control Criteria

Parameter	Allowable Limit
Solution:	
L1 Fixed	preferred for baselines < 10 km
iono-free fixed	baselines 10 km to 75 km
iono-free float	acceptable for baselines > 75 km
Reference Variance:	
Nominal value	1.0 to 10.0
Maximum NTE (L1 only)	10.0 (reject if > 20.0)
Maximum NTE (L1 & L2 iono free)	5.0 (reject if > 10.0)
RMS:	
< 5 km baseline	10 mm
< 20 km baseline	15 mm
20-50 km baseline	30 mm
NTE (with precise ephemeris)	50 mm
Variance Ratio for Integer solution	> 1.5 (fixed solution) < 1.5 (float solution) > 1.5 but < 3.0 (flag warning/suspect)
Satellite Residual Plot Deviation NTE	± 15 mm
Repeat baseline agreement	per FGCS standards

10-8. Examples of Baseline Reduction Software Output

The following pages contain example outputs from two processed baselines--one being a medium-length (26 km) ionospheric-free fixed solution and the second being a long (107 km) float solution. These baselines were observed using Ashtech receivers and were processed using Trimble WAVE Version 2.35 software. Explanatory annotations have been added to the first solution, and are similar on the 107 km solution.

IONOSPHERIC FREE FIXED DOUBLE DIFFERENCE BASELINE SOLUTION
MEDIUM LENGTH 26 KM BASELINE LENGTH (San Juan, PR--Puerto Nuevo Flood Control Project--
Jacksonville District)
(Trimble Navigation LTD--WAVE 2.35)

Project Name: [PUERTO NUEVO FLOOD CONTROL] 02097base
 Processed: Thursday, July 11, 2002 12:59
 WAVE 2.35
 Solution Output File (SSF): 00038752.SSF

From Station: COMERIO
 Data file: ____1732.RNX
 Antenna Height (meters): 2.122 True Vertical
 Position Quality: Point Positioning

FROM Station
RINEX file
Antenna hgt to
L1 phase ctr

Lat
Lon
ellip hgt

WGS 84 Position: 18° 14' 08.746057" N X 2444052.950
 66° 12' 52.306905" W Y -5545217.951
 150.797 Z 1983232.476

To Station: DRYDOCK
 Data file: DRYD1732.RNX
 Antenna Height (meters): 1.683 True Vertical

TO Station
RINEX file
Antenna hgt to
L1 phase ctr

Lat
Lon
ellip hgt

WGS 84 Position: 18° 26' 47.880251" N X 2452927.215
 66° 05' 28.532019" W Y -5533065.770
 -41.244 Z 2005326.605

Observed 5 hr 45 min @ 15-sec intervals

Start Time: 6/22/02 12:05:30.00 GPS (1171 561930.00)
 Stop Time: 6/22/02 17:51:15.00 GPS (1171 582675.00)
 Occupation Time Meas. Interval (seconds): 05:45:45.00 15.00

Solution Type: **Iono free fixed double difference**
 Solution Acceptability: Passed ratio test

Solution Type
Passed Variance Ratio Test

Ephemeris: Broadcast **Broadcast ephemeris used**
 Met Data: Standard

Slope distance and standard error

Baseline Slope Distance Std. Dev. (meters): 26731.603 ±0.000921

Normal Section Azimuth: Forward 29° 09' 11.458111" Backward 209° 11' 31.087237"
 Vertical Angle: -0° 31' 55.911654" 0° 17' 27.744089"

Forward & back
azimuths & vertical
angles

Baseline Components (meters): dx 8874.265 dy 12152.181 dz 22094.129
 Standard Deviations (meters): ±0.003151 ±0.006977 ±0.002847
 dn 23344.248 de 13021.638 du -248.296
 ±0.000927 ±0.000838 ±0.008072
 dh -192.041 ±0.008073

Geocentric
(x-y-z)
and N-E-Up
coordinates and
standard
errors

Covariance Matrix

$$\begin{vmatrix} \sigma_x^2 & \sigma_{xy} & \sigma_{xz} \\ \sigma_{yx} & \sigma_y^2 & \sigma_{yz} \\ \sigma_{zx} & \sigma_{zy} & \sigma_z^2 \end{vmatrix}$$

Apriori Covariance Matrix:
 9.931756E-006
 -2.104302E-005 4.868030E-005
 8.247290E-006 -1.865503E-005

Covariance Matrix: variances & correlations in x-y-z coords

8.107185E-006

Variance Ratio / Cutoff: 17.2 1.5
 Reference Variance: 4.845

Variance Ratio >>> than 3.0 ... good
Reference Variance < 5.0 ... OK

IONO FREE FLOAT DOUBLE DIFFERENCE BASELINE SOLUTION
LONG 107 KM BASELINE LENGTH (San Juan, PR--Puerto Nuevo Flood Control Project-Jacksonville District)
(Trimble Navigation LTD--WAVE 2.35)

Project Name: 02097base
 Processed: Thursday, July 11, 2002 12:20
 WAVE 2.35
 Solution Output File (SSF): 00038632.SSF
 From Station: PUR 3
 Data file: PUR3177L.RNX
 Antenna Height (meters): 0.000 True Vertical
 Position Quality: Point Positioning
 WGS 84 Position: 18° 27' 46.670415" N X 2358177.597
 67° 04' 01.076161" W Y -5573621.134
 90.397 Z 2007082.890
 To Station: PN 007
 Data file: 00071771.RNX
 Antenna Height (meters): 2.143 True Vertical
 WGS 84 Position: 18° 24' 00.838038" N X 2456974.099
 66° 03' 22.369643" W Y -5533057.526
 -30.064 Z 2000457.530
 Start Time: 6/26/02 15:06:40.00 GPS (1172 313600.00)
 Stop Time: 6/26/02 19:01:30.00 GPS (1172 327690.00)
 Occupation Time Meas. Interval (seconds): 03:54:50.00 30.00

Solution Type: Iono free float double difference
 Solution Acceptability: Acceptable

Ephemeris: Broadcast
 Met Data: Standard
 Baseline Slope Distance Std. Dev. (meters): 107004.909 0.005491

	Forward	Backward
Normal Section Azimuth:	93° 33' 38.001101"	273° 52' 48.487830"
Vertical Angle:	-0° 32' 41.904306"	-0° 24' 57.517184"

Baseline Components (meters): dx	98796.502	dy	40563.608	dz	-6625.360	
Standard Deviations (meters):	0.008147		0.011887		0.005161	
	dn	-6645.072	de	106793.528	du	-1017.770
		0.001934		0.005522		0.014145
	dh	-120.461		0.014166		

Aposteriori Covariance Matrix:	6.636701E-005			
	-6.583171E-005	1.413108E-004		
	2.961492E-005	-5.613399E-005	2.663405E-005	

Reference Variance: 5.359

Observable	Count/Rejected	RMS:	Iono free phase	2391/0	0.026
------------	----------------	------	-----------------	--------	-------

Ambiguity Summary (cycles):	SV	Ambiguity	Error
Iono free	04	-39932607.484	± 0.251
	04	-41411233.741	± 0.284
	05	-19296720.802	± 0.357
	06	-31002785.279	± 0.187

IONO FREE FLOAT DOUBLE DIFFERENCE BASELINE SOLUTION
LONG 107 KM BASELINE LENGTH (Continued)

09	-34051430.580	± 0.109
10	25.791	± 0.105
10	-31703542.767	± 0.157
15	-20292127.579	± 0.224
17	-28200241.402	± 0.178
18	-27143528.717	± 0.333
23	-25788558.784	± 0.112
24	-9579372.631	± 0.139
26	-297437.123	± 0.069

Processor Controls:

[General]

Process start time: 6/26/02 11:02:00 GPS (1172 298920)

Process stop time: 6/26/02 20:59:10 GPS (1172 334750)

Elevation mask: 15 degrees

Maximum iterations: 10

Maximum fixable cycle slip: 600 seconds

Ephemeris: Broadcast

Residuals: Disabled

Antenna phase correction: Enabled

[Observables]

L1 phase Enabled

L2 phase Enabled

Squared L2 phase Enabled

L2 P code Enabled

L1 C/A code Enabled

L2 code (encrypted) Enabled

[Static Network]

Baseline generation: All baselines

Min baseline observation time: 120 seconds

[Quality]

Observation editing: Edit multiplier 3.5

Ratio test: Cutoff 1.5

Reference variance test: Disabled

[Tropo Correction]

Model: Hopfield

Estimated zenith delay interval: 2 hours

Use observed mets: Enabled

[Iono Correction] Ambiguity Pass Final Pass

Correction: Iono free Iono free

Applied to: Static, Kinematic Static,

Kinematic

Application threshold: 10 kilometers 5 kilometers

[Final Solution]

Final solution type: L1 Fixed

[Satellites]

Disabled:

10-9. Baseline Reduction Summaries

The following list is a typical report of baseline reductions performed over a network. For each baseline, the report lists the solution type, slope distance, reference variance, and ratio (for fixed solutions). Such a report is of value in assessing the overall quality of baselines in a network prior to performing rigorous adjustments. Most of the baselines less than 5 km have fixed solutions. Iono free fixed solutions were obtained in baselines up to and exceeding 100 km, most likely because observation times typically exceeded 6 hours over these lines and the integers were reliably fixed, albeit with smaller ratios. Lines not fixed had float solutions.

Sample Baseline Reduction Project Summary Report (Trimble Navigation LTD) Puerto Nuevo, San Juan Puerto Rico--July 2002 (RLDA Inc.--Jacksonville District)

Station (From)	Station (To)	Solution Type	Slope Dist (m)	Ratio	Reference Variance	Entered (From)	Ant Hgt (To)
A 1001	MESAS	Iono free fixed	20841.965	6.6	3.814	1.674	1.559
A 1001	SJH 44	L1 fixed	4426.843	13.3	11.994	2.125	1.714
COMERIO	A 1001	Iono free float	28604.039		3.059	2.122	2.125
COMERIO	DRYDOCK	Iono free fixed	26731.603	17.2	4.845	2.122	1.683
COMERIO	MESAS	Iono free fixed	17436.970	20.4	3.522	2.122	1.504
COMERIO	MP 1	Iono free fixed	26466.871	15.9	3.535	2.122	1.651
COMERIO	SJH 44	Iono free fixed	26791.206	8.0	3.748	2.122	1.714
DRYDOCK	A 1001	L1 fixed	2099.928	3.5	23.933	1.683	2.125
DRYDOCK	SJH 44	L1 fixed	2986.722	4.1	19.858	1.683	1.714
MESAS	A 1001	Iono free fixed	20841.967	1.5	3.761	1.504	2.125
MESAS	DRYDOCK	Iono free fixed	19984.666	16.6	5.558	1.504	1.683
MESAS	SJH 44	Iono free fixed	21973.981	9.3	2.783	1.504	1.714
MP 1	A 1001	L1 fixed	2160.311	4.0	21.693	1.651	2.125
MP 1	PN 007	Iono free fixed	5114.381	19.0	4.801	1.775	2.143
MP 1	PN 030	L1 fixed	4609.931	8.5	27.470	1.775	1.656
MP 1	PUR 3	Iono free fixed	104015.014	2.3	9.541	2.125	0.000
MP 1	RRS 1	L1 fixed	3154.302	50.0	23.107	1.775	0.000
MP 3	TATI	L1 fixed	2605.904	15.4	37.889	1.717	0.000
PN 007	A 1001	Iono free fixed	6568.337	4.3	3.786	2.143	1.674
PN 030	MESAS	Iono free fixed	14465.715	11.5	5.609	1.715	1.559
PN 030	MP 3	L1 fixed	4721.907	30.6	44.769	1.656	1.717
PN 030	PN 007	L1 fixed	2845.129	21.9	34.393	1.656	2.143
PN 030	RRS 1	Iono free fixed	6624.379	14.0	3.073	1.656	0.000
PUR 3	A 1001	Iono free float	104825.284		2.262	0.000	1.674
PUR 3	A 1001	Iono free float	104825.202		2.859	0.000	2.125
PUR 3	COMERIO	Iono free fixed	93542.150	4.3	13.202	0.000	2.122
PUR 3	DRYDOCK	Iono free fixed	103078.898	2.4	19.846	0.000	1.683
PUR 3	MESAS	Iono free fixed	109219.386	3.3	15.726	0.000	1.504
PUR 3	MP 1	Iono free fixed	104015.205	5.4	22.988	0.000	1.651
PUR 3	MP 3	Iono free fixed	105251.631	4.0	10.456	0.000	1.717
PUR 3	PN 007	Iono free float	107004.909		5.359	0.000	2.143
PUR 3	PN 030	Iono free fixed	104207.465	22.5	6.769	0.000	1.715
PUR 3	RRS 1	Iono free fixed	106835.866	7.8	5.010	0.000	0.000
PUR 3	SJH 44	Iono free fixed	100402.386	3.8	10.331	0.000	1.621
PUR 3	SJH 44	Iono free float	100402.461		2.740	0.000	1.714
PUR 3	SJH 44	Iono free fixed	100402.341	3.7	8.679	0.000	1.666
PUR 3	SJHL1RM	Iono free float	101479.646		3.355	0.000	2.125
PUR 3	TATI	Iono free fixed	104537.036	3.8	8.956	0.000	0.000
RRS 1	PN 007	Iono free fixed	5639.477	9.6	4.974	0.000	2.143
SJH 44	A 1001	L1 fixed	4426.901	4.8	12.273	1.621	1.674
SJH 44	MESAS	Iono free fixed	21973.970	8.4	5.657	1.621	1.559
SJH 44	MP 1	L1 fixed	4201.519	2.9	21.210	1.611	2.125

**Sample Baseline Reduction Project Summary Report (Trimble Navigation LTD)--Continued
Puerto Nuevo, San Juan Puerto Rico--July 2002 (RLDA Inc.--Jacksonville District)**

Station (From)	Station (To)	Solution Type	Slope Dist (m)	Ratio	Reference Variance	Entered (From)	Ant (To)	Hgt (To)
SJH 44	MP 1	L1 fixed	4201.586	38.9	25.690	1.666		1.775
SJH 44	MP 3	Iono free fixed	5319.058	27.9	5.499	1.666		1.717
SJH 44	PN 007	Iono free fixed	9092.812	1.7	5.592	1.621		2.143
SJH 44	PN 030	Iono free fixed	7680.376	20.4	6.122	1.666		1.656
SJH 44	PUR 3	Iono free fixed	100402.358	8.0	6.727	1.611		0.000
SJH 44	RRS 1	Iono free fixed	6481.387	61.2	4.617	1.666		0.000
SJH 44	SJHL11RM	L1 fixed	3556.239	2.1	11.339	1.621		2.125
SJH 44	TATI	Iono free fixed	6204.031	8.0	5.361	1.666		0.000
SJHL11RM	A 1001	L1 fixed	4682.576	10.0	7.149	2.125		1.674
SJHL11RM	MESAS	Iono free float	18419.372		5.138	2.125		1.559
SJHL11RM	PN 007	Iono free fixed	6188.465	1.8	4.479	2.125		2.143
SJHL11RM	PN 030	L1 fixed	4247.108	1.6	31.691	2.125		1.715
TATI	PN 007	L1 fixed	2943.738	15.0	29.619	0.000		2.143
TATI	RRS 1	L1 fixed	4586.193	17.5	36.664	0.000		0.000

**** End of Report ****

Other useful baseline reduction summaries include satellite tracking summaries depicting signal losses, cycle slips, or residual plots for each satellite observed. These plots may be used to decide whether poor satellites should be removed from the reduction. In addition, graphical summary plots are much easier to review than pages of statistical text. A unique type of graphical baseline quality plot is shown in the following figure from Waypoint Consulting, Inc. In this plot, a quality number (from one to six) is computed using seven different baseline reduction statistics. A "good" quality value of "1" would represent a fixed integer solution, while values of 5-6 indicate worse DGPS accuracies. Each epoch is plotted with a certain color depending on its quality number, which allows for a quick visual inspection. Waypoint GrafNAV baseline reduction software contains options for 26 different types of graphical plots for use in assessing baseline quality. These include plots such as DOPs, L1 phase RMS, C/A-code RMS, forward/reverse separation, quality number, standard deviation, L1 Doppler RMS, ambiguity drift (i.e. solution stability), forward/reverse weighting, and satellite elevation and loss of lock plots for each satellite being tracked. Other commercial baseline reduction software provides options for similar graphical assessment features.

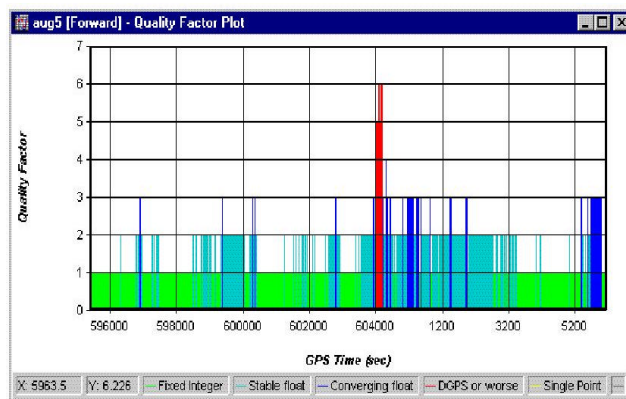

Figure 10-5. Typical quality factor plot for a baseline (Waypoint Consulting, Inc. GrafNAV)

10-10. Baseline Reduction in Mapping Grade GPS Receivers

Small hand-held, mapping grade GPS receivers are easy and efficient to operate, with minimal training. They are capable of achieving decimeter-level accuracy when paired and post-processed with a nearby CORS base station receiver. The software for performing the baseline reduction and position computation is fairly simple to operate. The following listing is an example of GPS positions logged by a hand-held Trimble GeoExplorer on points that potentially impact maintenance dredging limits. The resultant accuracy of the points is about 2 feet (95% RMS), which is more than adequate for defining dredging limits. The baseline reduction was performed using a nearby CORS reference station in Miami, FL.

LOCATIONS OF DOCKS AND BULKHEADS ALONG THE MIAMI RIVER

Sample results from post-processed differential carrier observations using nearest CORS station in Miami, FL. GeoExplorer carrier phase differential data--5-sec update rate. All Float solutions

Point	Ref No.	Point Description	FL SP Coordinate		Obs	95% Precision *			
			X	Y		Y	X	X-Y	Z
38-1	38	Concrete Bulkhead, in line with East edge of Building	920,742.89	522,331.98	720	0.6 ft	0.6 ft	0.8 ft	0.9 ft
38-2	38	Concrete Bulkhead, in line with West edge of Building	920,696.28	522,324.20	120	1.0 ft	1.0 ft	1.3 ft	1.6 ft
94-3	94	Northeast corner of concrete pier @ La Coloma Marina	918,350.11	525,035.11	723	0.5 ft	0.5 ft	0.7 ft	0.8 ft
94-4	94	Northwest corner of concrete pier @ La Coloma Marina	918,343.00	525,039.66	101	1.2 ft	1.2 ft	1.6 ft	2.7 ft
110-5	110	Point on corrugated steel bulkhead	917,156.88	525,821.07	676	0.9 ft	0.9 ft	1.1 ft	1.6 ft
116-6	116	Northeast corner of wooden pier @ Langer-Krell Marine Electronics	916,946.64	525,963.01	724	0.5 ft	0.5 ft	0.6 ft	0.7 ft
46-7	46	Northeast corner of wooden pier	919,868.69	522,728.61	794	0.5 ft	0.5 ft	0.7 ft	1.4 ft
46-8	46	Point on concrete bulkhead	919,736.36	522,881.29	200	1.8 ft	1.8 ft	2.3 ft	6.8 ft **
177-9	177	Southwest corner of finger pier @ Hurricane Cove Marina	910,470.96	528,929.65	724	0.6 ft	0.6 ft	0.8 ft	0.8 ft
177-10	177	Southwest corner of finger pier @ Hurricane Cove Marina	910,574.96	528,899.27	181	0.9 ft	0.9 ft	1.2 ft	2.7 ft
177-11	177	Southwest corner of finger pier @ Hurricane Cove Marina	910,692.35	528,851.62	168	1.2 ft	1.2 ft	1.5 ft	3.8 ft

* computed by Trimble Pathfinder Office software

** apparent multipath problem at this point

10-11. Field/Office Loop Closure Checks

Post-processing criteria are aimed at an evaluation of a single baseline. In order to verify the adequacy of a group of connected baselines, one must perform a loop closure computation on the formulated baselines. When GPS baseline traverses or loops are formed, their linear (internal) closure should be determined in the field. If job requirements are less than Third-Order (1:10,000 or 1:5,000), and the internal loop/traverse closures are very small, a formal (external) adjustment may not be warranted.

a. Loop closure software packages. The internal closure determines the consistency of the GPS measurements. Internal closures are applicable for loop traverses and GPS networks. It is required that one baseline in the loop be independent. An independent baseline is observed during a different session or different day. Today, most post-processing software packages come with a loop closure program, such as the example in Figure 10-6. These loop closure routines allow for a graphical selection of baselines in a network from which a loop closure is automatically computed in real-time. Refer to the individual manufacturer post-processing user manuals for a discussion on the particulars of the loop closure program included with the user hardware.

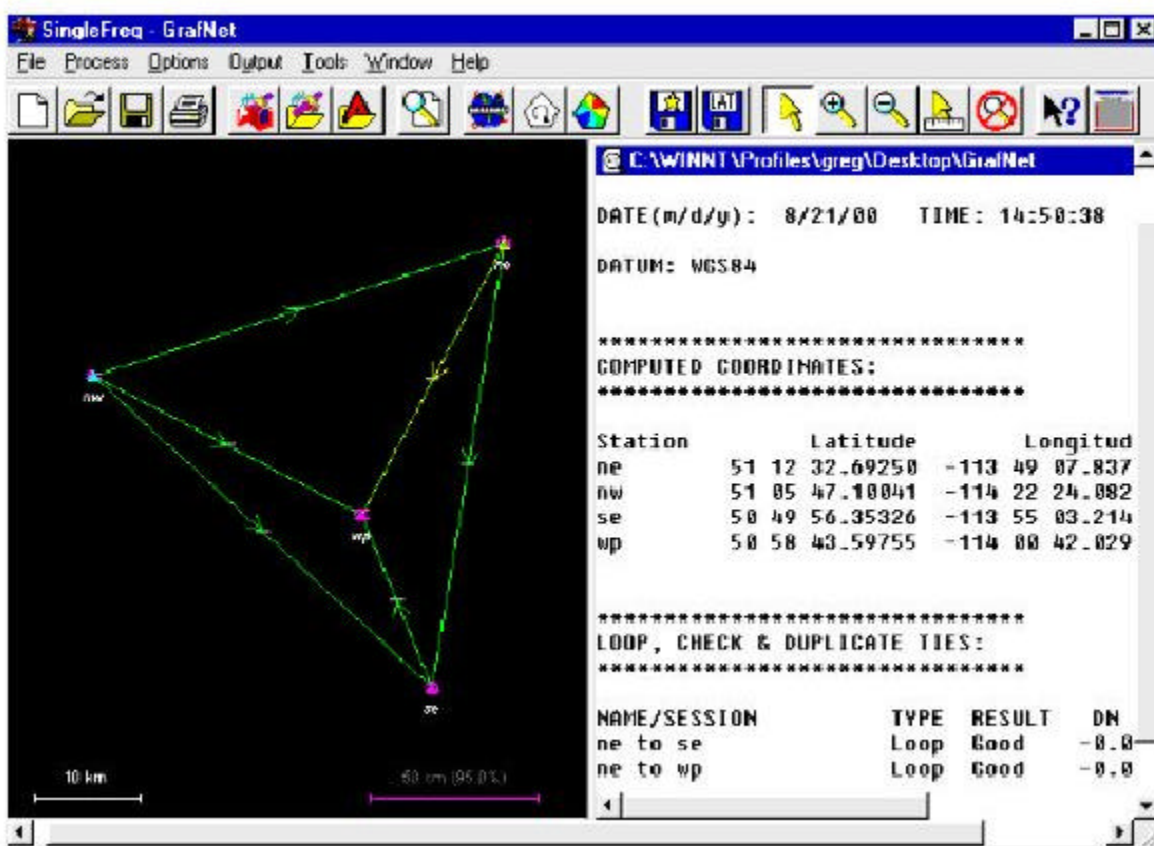

Figure 10-6. Loop closure diagram (Waypoint GrafNet)

b. General loop closure procedure. If the user post-processing software package does not contain a loop closure program, the user can perform a loop closure as shown below.

(1) List the Δx - Δy - Δz differences and length of the baseline being used in a table of the form shown in Table 10-4.

Table 10-4. Loop Closure Procedure

Baseline	Julian		Δx	Δy	Δz	Δ Distance
	Day	Session				
Baseline #1	Day	#	Δx #1	Δy #1	Δz #1	Distance #1
Baseline #2	Day	#	Δx #2	Δy #2	Δz #2	Distance #2
Baseline #3	Day	#	Δx #3	Δy #3	Δz #3	Distance #3

(2) Sum up the Δx - Δy - Δz differences and distance components for all baselines used in the loop closure. For instance, for the baselines in Table 10-4, the summation would be $\Sigma\Delta x$, $\Sigma\Delta y$, $\Sigma\Delta z$, and Σ Distances or $(\Delta x\#1 + \Delta x\#2 + \Delta x\#3)$, $(\Delta y\#1 + \Delta y\#2 + \Delta y\#3)$, $(\Delta z\#1 + \Delta z\#2 + \Delta z\#3)$, and $(\Delta$ Distance#1 + Δ Distance#2 + Δ Distance#3), respectively.

(3) Once summation of the Δx , Δy , Δz , and Δ Distance components has been completed, the square of each of the summations should be added together and the square root of this sum then taken. This resultant value is the misclosure vector for the loop. This relationship can be expressed in the following manner:

$$m = [(\Sigma\Delta x^2) + (\Sigma\Delta y^2) + (\Sigma\Delta z^2)]^{1/2} \quad (\text{Eq 10-7})$$

where

- m = misclosure for the loop
- $\Sigma\Delta x$ = sum of all Δx vectors for baselines used
- $\Sigma\Delta y$ = sum of all Δy vectors for baselines used
- $\Sigma\Delta z$ = sum of all Δz vectors for baselines used

(4) The loop misclosure ratio may be calculated as follows:

$$\text{Loop misclosure ratio} = m/L \quad (\text{Eq 10-8})$$

where

- L = total loop distance (perimeter distance)

(5) The resultant value can be expressed in the following form:

1: Loop Misclosure Ratio

with all units for the expressions being in terms of the units used in the baseline formulations (e.g., m, ft, mm, etc.).

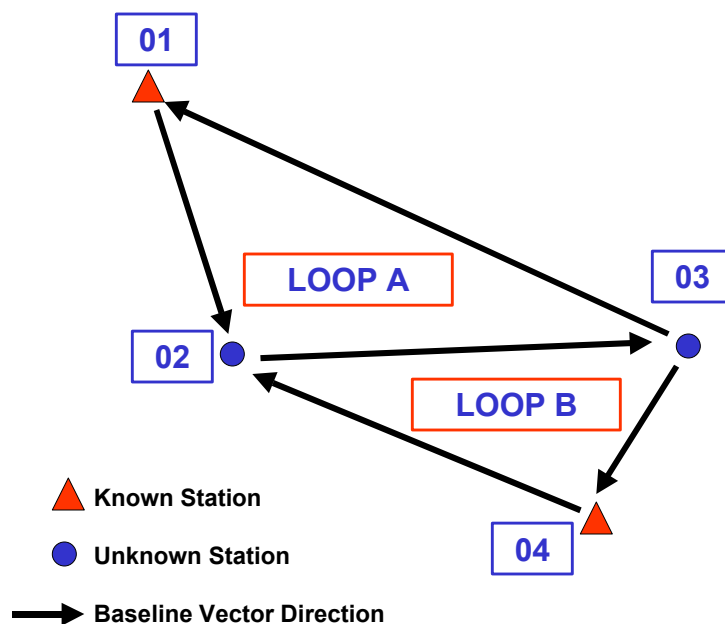

Figure 10-7. Internal loop closure scheme

c. *Sample loop closure computation.* Figure 10-7 shows two loops that consist of four stations. Stations 01 and 04 were known control stations. During Session A on day 065, three GPS receivers observed the baselines between Stations 01, 02, and 03 for approximately 1 hour. The receivers were then turned off and the receiver at Station 01 was moved to Station 04. The tripod heights at Stations 02 and 03 were adjusted. The baselines between Stations 02, 03, and 04 were then observed during Session B, day 065. This provided an independent baseline for both loops.

(1) The closure for loop 01-02-03 is computed with the vectors 01-02 and 01-03, day 065, session A, and the vector 02-03, day 065, session B. The vector 02-03 from session B provides an independent baseline. The loop closure is determined by arbitrarily assigning coordinate values of zero to station 01 ($X=0, Y=0, Z=0$). The vector from 01-02 is added to the coordinates of Station 01. The vector from 02-03, session B, is added to the derived coordinates of Station 02. The vector from 03-01 is then added to the station coordinates of 02. Since the starting coordinates of Station 01 were arbitrarily chosen as zero, the misclosure is then the computed coordinates of Station 01 (dx, dy, dz). The vector data are listed in Table 10-5.

Table 10-5. Vector Data for Stations 01, 02, and 03

Baseline	Julian Day	Session	ΔX	ΔY	ΔZ	Δ Distance
01-02	065	A	-4077.865	-2877.121	-6919.829	8531.759
02-03	065	B	7855.762	-3129.673	688.280	8484.196
03-01	065	A	-3777.910	6006.820	6231.547	9443.869

(2) To determine the relative loop closure, the square root of the sum of the squares of the loop misclosures (m_x , m_y , m_z) is divided into the perimeter length of the loop:

$$\text{Loop misclosure ratio} = [1 / L] \cdot [(\Delta x^2) + (\Delta y^2) + (\Delta z^2)]^{1/2} \quad (\text{Eq 10-9})$$

Where the perimeter distance (L) = Distance 01-02 + Distance 02-03 + Distance 03-01, or:

$$L = 8531.759 + 8484.196 + 9443.869 = 26,459.82$$

And where distance 03-01 was computed from:

$$(-3777.912^2 + 6006.8202^2 + 6231.5472^2)^{1/2} = 9443.869$$

(Other distances are similarly computed)

Summing the misclosures in each coordinate:

$$\Delta x = -4077.865 + 7855.762 - 3777.910 = -0.0135$$

$$\Delta y = -2877.121 - 3129.673 + 6006.820 = +0.0264$$

$$\Delta z = -6919.829 + 688.280 + 6231.547 = -0.0021$$

then the loop misclosure is

$$(\Delta x^2 + \Delta y^2 + \Delta z^2)^{1/2} = 0.029$$

$$\text{Loop Misclosure Ratio} = 0.029/26,459.82 \text{ or (approximately) 1 part in 912,000 (1:912,000)}$$

(3) This example is quite simplified; however, it illustrates the necessary mechanics in determining internal loop closures. The values Δx , Δy , and Δz are present in the baseline output files. The perimeter distance is computed by adding the distances between each point in the loop.

d. External closures. External closures are computed in a similar manner to internal loops. External closures provide information on how well the GPS measurements conform to the local coordinate system. Before the closure of each traverse is computed, the latitude, longitude, and ellipsoid height must be converted to geocentric coordinates (X,Y,Z). If the ellipsoid height is not known, geoid modeling software can be used with the orthometric height to get an approximate ellipsoid height. The external closure will aid the surveyor in determining the quality of the known control and how well the GPS measurements conform to the local network. If the control stations are not of equal precision, the external closures will usually reflect the lower-order station. If the internal closure meets the requirements of the job, but the external closure is poor, the surveyor should suspect that the known control is deficient and an additional known control point should be tied into the system.

10-12. On-Line Positioning User Service (OPUS)

OPUS is a free on-line baseline reduction and position adjustment service provided by the National Geodetic Survey. OPUS provides an X-Y-Z baseline reduction and position adjustment relative to three nearby national CORS reference stations. OPUS is ideal for establishing accurate horizontal control relative to the NGRS. It can also be used as a quality control check on previously established control points. OPUS input is performed "on-line" by entering at least two hours of static, dual-frequency GPS

RINEX data--see Figure 10-8. The resultant adjustment is returned in minutes via e-mail. Either the ultra-rapid or precise ephemeris is used for the solution.

The screenshot shows the OPUS web input screen. At the top, the word "OPUS" is displayed in a stylized font. Below it, there are six numbered input fields:

1. A text input field for "Enter your email address".
2. A text input field for "Enter your RINEX file" with a "Browse..." button to its right.
3. A dropdown menu for "Select the antenna type" with "NONE" selected.
4. A text input field for "Enter the antenna height" with "0.0" entered and "meters" to its right.
5. A dropdown menu for "Optional: State Plane Coordinates" with "0" and "none" selected.
6. An "Upload File" button.

At the bottom, there is a "Reminders:" section with the following text:

email correct?	correct rinex name?
no kinematic data	minimum of 2 hours of data
dual frequency data	data rates of 1, 2, 3, 5, 6, 10, 15 or 30 seconds

Figure 10-8. On-Line Positioning User Service (OPUS) Web input screen

a. *On-line data input.* OPUS is accessed at the following web page address: www.ngs.noaa.gov/OPUS. The various data on the screen in Figure 10-8 are entered, e.g., e-mail address, RINEX file path, antenna height, and local SPCS code. The antenna height in meters is the vertical (not slope) distance measured between the monument/benchmark and the antenna reference point (ARP). The ARP is almost always the center of the bottom-most, permanently attached, surface of the antenna. If 0.0000 meters is entered for the height, OPUS will return the position of the ARP. The type of antenna is selected from the drop down menu.

b. *Solution.* OPUS computes an average solution from the three baselines. NGS baseline reduction software is used for the solutions. Output positions are provided in both ITRF and NAD 83. An overall RMS (95%) confidence for the solution is provided, along with maximum coordinate spreads between the three CORS stations for both the ITRF and NAD 83 positions. An orthometric elevation on NAVD 88 is provided using the Geoid 99 model. The orthometric accuracy shown is a function of the spread between the three redundant baseline solutions.

c. *Sample adjustment.* The following example was performed to locate a permanently mounted GPS antenna that is used for real-time kinematic hydrographic surveys and dredging on the St. Marys River offshore entrance channel leading to the Kings Bay FBM Submarine Base. This antenna point was originally positioned in 1997 relative to local NGRS/HARN control. The NAVD 88 elevation was established in 1997 using conventional differential levels. Five hours of dual-frequency data were recorded in May 2002 and processed in OPUS against three distant CORS points in Charleston, SC, Cape

Canaveral, FL, and Savannah, GA. The solution was performed using both the Rapid Ephemeris and Precise Ephemeris.

**OPUS Solution: Kings Bay FBM Submarine Base Entrance Channel
Fernandina Pier Bath House RTK GPS Antenna**

FILE: 58421440.02o

2004 WARNING! The IGS precise orbit was not available at processing *[Rapid orbit will be used]*
2004 time. The IGS rapid orbit was/will be used to process the data.

2004

1008 WARNING! Antenna offsets supplied by the user in the RINEX *[permanent RTK antenna mounted on*
1008 header or via the web were zero. Coordinates returned will *mast above Bath House]*

1008 be for the antenna reference point (ARP). Please refer to

1008 the following web address for an example.

1008 <http://www.ngs.noaa.gov/CORS/OPUS/Preprinfile.html>

NGS OPUS SOLUTION REPORT (RAPID EPHEMERIS)

USER: francis.m.woodward@saj02.usace.a DATE: May 28, 2002

RINEX FILE: 58421440.02o TIME: 18:10:55 UTC

SOFTWARE: page5 0203.19 START: 2002/05/24 13:05:00

EPHEMERIS: igr11675.eph [rapid] STOP: 2002/05/24 18:05:00 *[5 hours of observation]*

NAV FILE: brdc1440.02n OBS USED: 8259 / 9034 : 91%

ANT NAME: TRM22020.00+GP # FIXED AMB: 63 / 71 : 89%

ARP HEIGHT: 0.0 OVERALL RMS: 0.021(m) *[overall solution RMS 95%]*

[Adjusted positions ... note that accuracy estimates are based on maximum spread between 3 solutions]

REF FRAME:	NAD83(CORS96)(EPOCH:2002.0000)	[spread]	ITRF00 (EPOCH:2002.3936)	[spread]
X:	818024.398(m)	0.014(m)	818023.781(m)	0.014(m)
Y:	-5427733.157(m)	0.055(m)	-5427731.620(m)	0.057(m)
Z:	3237328.073(m)	0.033(m)	3237327.879(m)	0.034(m)
LAT:	30 41 59.95964	0.003(m)	30 41 59.98095	0.003(m)
E LON:	278 34 14.36555	0.011(m)	278 34 14.35123	0.012(m)
W LON:	81 25 45.63445	0.011(m)	81 25 45.64877	0.012(m)
EL HGT:	-20.012(m)	0.065(m)	-21.497(m)	0.067(m)
ORTHO HGT	8.591(m)	0.069(m) [Geoid99 NAVD88]		

UTM: Zone 17
NORTHING: 3396432.577(m)
EASTING: 458884.381(m)

SPC: Zone 1001(GA)
NORTHING: 77823.887(m)
EASTING: 270630.929(m)

BASE STATIONS USED

PID	DESIGNATION	LATITUDE	LONGITUDE	DISTANCE(m)
AH6078	sav1 SAVANNAH 1 CORS ARP	N320818	W0814146	161511
AH2496	ccv3 CAPE CANAVERAL 3 CORS ARP	N282736	W0803242	262608
AF9630	cha2 CHARLESTON 2 CORS ARP	N324526	W0795035	273177

NEAREST NGS PUBLISHED CONTROL POINT

BC1755	FERNA RESET	N304207	W0812602	487
--------	-------------	---------	----------	-----

This position was computed without any knowledge by the National Geodetic Survey regarding the equipment or field operating procedures used.

EM 1110-1-1003
1 Jul 03

OPUS Solution: Kings Bay FBM Submarine Base Entrance Channel (Continued)

RECOMPUTING WITH PRECISE EPHEMERIS:

SOFTWARE: page5 0203.19	START: 2002/05/24 13:05:00
EPHEMERIS: igs11675.eph [precise]	STOP: 2002/05/24 18:05:00
NAV FILE: brdc1440.02n	OBS USED: 8259 / 9034 : 91%
ANT NAME: TRM22020.00+GP	# FIXED AMB: 63 / 71 : 89%
ARP HEIGHT: 0.0	OVERALL RMS: 0.021(m)

REF FRAME: NAD83(CORS96)(EPOCH:2002.0000) ITRF00 (EPOCH:2002.3936)

X:	818024.399(m)	0.013(m)	818023.781(m)	0.013(m)
Y:	-5427733.166(m)	0.060(m)	-5427731.630(m)	0.062(m)
Z:	3237328.081(m)	0.039(m)	3237327.888(m)	0.041(m)
LAT:	30 41 59.95972	0.004(m)	30 41 59.98104	0.005(m)
E LON:	278 34 14.36552	0.014(m)	278 34 14.35117	0.016(m)
W LON:	81 25 45.63448	0.014(m)	81 25 45.64883	0.016(m)
EL HGT:	-20.000(m)	0.070(m)	-21.484(m)	0.073(m)
ORTHO HGT:	8.603(m)	0.075(m) [Geoid99 NAVD88]		

SUMMARY OF SOLUTION RESULTS

	1997 POSITION	OPUS (RAPID)	Diff	OPUS (PRECISE)	Diff
Lat:	30-41-59.9588	30-41-59.95964	2 cm	30-41-59.95972	3 cm
Lon:	81-25-45.6344	81-25-45.63445	0 cm	81-25-45.63448	0 cm
Ellip Hgt:	-20.015 m	-20.012 m	3 mm	-20.000 m	15 mm

The above example illustrates the reliability of an OPUS solution in the horizontal plane. The position difference between the old 1997 position and the 2002 OPUS/CORS solution is at the few centimeter-level and is therefore insignificant for the purposes of the project control function. Although the ellipsoid elevation agreed to within a few millimeters, this OPUS solution should not be relied on given the large estimated variances between the baselines. This large variance illustrates that vertical control cannot be reliably extended over baselines of this length. It is also apparent in this example that the differences between the rapid ephemeris and precise ephemeris were not significant for this observation series. The following OPUS solution illustrates a case where two nearby CORS stations were used in the solution. Horizontal accuracies using the ultra-rapid orbit were at the centimeter level.

OPUS Solution using two nearby CORS stations--New Orleans District

Huber, Mark W MVN

From: opus@ngs.noaa.gov
Sent: Thursday, March 28, 2002 2:17 PM
To: Huber, Mark W
Subject: OPUS solution : lms60871.02o

FILE: lms60871.02o

2005 WARNING! The IGS precise and IGS rapid orbits were not available
2005 at processing time. The IGS ultra-rapid orbit was/will be used to
2005 process the data.
2005

NGS OPUS SOLUTION REPORT
=====

USER: mark.w.huber\@mvn02.usace.army.mi DATE: March 28, 2002
RINEX FILE: lms60871.02o TIME: 20:16:31 UTC

SOFTWARE: page5 0102.26 START: 2002/03/28 15:10:00
EPHEMERIS: igu11594.eph [ultra-rapid] STOP: 2002/03/28 18:33:00
NAV FILE: brdc0870.02n OBS USED: 3904 / 3998 : 98%
ANT NAME: TRM22020.00+GP # FIXED AMB: 31 / 34 : 91%
ARP HEIGHT: 1.5895 OVERALL RMS: 0.018 (m)

REF FRAME: NAD83(CORS96) ITRF00 (EPOCH:2002.2375)

X:	-13017.957 (m)	0.006 (m)	-13018.572 (m)	0.002 (m)
Y:	-5531626.227 (m)	0.015 (m)	-5531624.732 (m)	0.007 (m)
Z:	3164465.455 (m)	0.011 (m)	3164465.266 (m)	0.007 (m)
LAT:	29 56 18.86623	0.003 (m)	29 56 18.88512	0.008 (m)
E LON:	269 51 54.58370	0.006 (m)	269 51 54.56066	0.002 (m)
W LON:	90 8 5.41630	0.006 (m)	90 8 5.43934	0.002 (m)
EL HGT:	-19.076 (m)	0.018 (m)	-20.464 (m)	0.008 (m)
ORTHO HGT:	7.041 (m)	0.031 (m)	[Geoid99 NAVD88]	
UTM:	Zone 15			
NORTHING:	3315431.810 (m)			
EASTING:	776566.549 (m)			
SPC:	Zone 1702 (LA)			
NORTHING:	160062.781 (m)			
EASTING:	1115698.887 (m)			

BASE STATIONS USED

PID	DESIGNATION	LATITUDE	LONGITUDE	DISTANCE (m)
AF9544	eng1 ENGLISH TURN 1 CORS ARP	N295244	W0895630	19786
AF9574	ndbc STENNIS CORS ARP	N302122	W0893636	68543
AF9559	mob1 MOBILE POINT 1 CORS ARP	N301339	W0880126	205980

NEAREST NGS PUBLISHED CONTROL POINT

AU0558	50+38.40 USE	N295618	W0900805	29
--------	--------------	---------	----------	----

This position was computed without any knowledge by the National Geodetic Survey regarding the equipment or field operating procedures used.

10-13. Scripps Coordinate Update Tool (SCOUT)

SCOUT is another free differential GPS baseline processing service that operates similarly to OPUS. The major difference is that SCOUT uses nearby International GPS Service (IGS) stations, which are more densely spaced than CORS. A RINEX file is uploaded for adjustment using an ftp access point--see the SCOUT input box in Figure 10-9. A minimum observation time of one hour is recommended. SCOUT is operated by the Scripps Orbit and Permanent Array Center (SOPAC) at the Scripps Institution of Oceanography, University of California, San Diego, in La Jolla, California. SOPAC's primary scientific role is to support high precision geodetic and geophysical measurements using GPS satellites, particularly for the study of earthquake hazards, tectonic plate motion, plate boundary deformation, and meteorological processes. SOPAC investigators also conduct research on the implementation, operation and scientific applications of continuously monitoring GPS arrays and Synthetic Aperture Radar (SAR) interferometry. SOPAC is a major participant in projects for the International GPS Service for Geodynamics (IGS), the Southern California Integrated GPS Network (SCIGN), the University NAVSTAR Consortium (UNAVCO), NOAA's Forecast Systems Laboratory (FSL), and the California Spatial Reference Center (CSRC).

Scripps Coordinate Update Tool (SCOUT)

[Documentation](#)

Notice: SCOUT supports [these GPS models](#) only. Do not use RINEX files from other models with dummy equipment selected.

Your e-mail address:
(e.g., jdoe@hostname.com)

Select one of the following two methods to provide your input RINEX file:

- Files may be in obs (o) or hatanaka (d) format, and may be compressed (.Z, .gz, .bz, .bz2)
 - Note:** Minimum [recommended](#) file time span: 1 hour

1) URL of anonymous ftp RINEX file:
(e.g., ftp://machinename.com/pub/rinex/site3650.98o.Z)

2) Select a RINEX file from SOPAC's upload directory: [Help](#)
Upload files to: ftp://geopub.ucsd.edu/pub/scout
username: scout password: coordgen

Note: Recently-uploaded files may not appear in this pull-down.
Hold down the Shift key and press Reload (or Refresh) on your browser to update the list.

Optional: Provide up to four reference site codes (four characters each, separated by spaces)-->

Figure 10-9. Scripps Coordinate Update Tool (SCOUT) Web input screen

10-14. Automated GIPSY Analyses (Jet Propulsion Laboratory)

GIPSY is a free point processing service which performs a single point solution. Its e-mail/ftp interface is known as auto-GIPSY or "ag." It does a basic analysis of GPS data in a RINEX file. All the processing occurs on a computer at JPL using final orbital data. E-mail is used to inform "ag" about the location of user data. E-mail is then sent from "ag" to inform the user about the location of the results. Anonymous ftp is used by "ag" to retrieve the results. Users need to place their RINEX observation file--preferably compressed--in an area that is accessible by anonymous ftp. Its name should conform to the RINEX standard. Point solutions should be returned in a few minutes. JPL claims accuracies of a few mm in horizontal components and about a cm in the vertical for data from a stationary site with a geodetic-quality receiver. GIPSY does not make corrections for antenna heights.

10-15. Baseline Data Management and Archival

The raw data are defined as data recorded during the observation period. Raw data shall be stored on an appropriate medium (CD-ROM, portable hard drive, magnetic tape, etc.). The raw data and the hard copy of the baseline reduction (resultant baseline formulations) shall be stored at the discretion of each USACE Command. See also data archiving requirements covered in Chapter 11.

Chapter 11 Adjustment of GPS Surveys

11-1. General

Differential carrier phase GPS survey observations are adjusted no differently than conventional, terrestrial EDM surveys. Each three-dimensional GPS baseline vector is treated as a separate distance observation and adjusted as part of a trilateration network. A variety of techniques may be used to adjust the observed GPS baselines to fit existing control. Since GPS survey networks often contain redundant observations, they are usually adjusted by some type of rigorous least-squares minimization technique. This chapter describes some of the methods used to perform GPS survey adjustments and provides guidance in evaluating the adequacy and accuracy of the adjustment results.

11-2. Adjustment Considerations

a. This chapter primarily deals with the adjustment of horizontal control established using GPS observations. Although vertical elevations are necessarily carried through the baseline reduction and adjustment process, the relative accuracy of these GPS-derived elevations is normally inadequate for many engineering and construction purposes. Special techniques and constraints are necessary to determine approximate orthometric elevations from relative GPS observations, as were described in Chapter 8.

b. The baseline reduction process (described in Chapter 10) directly provides the raw baseline distances and relative position coordinates that are used in a 3-D GPS network adjustment. In addition, and depending on the vendor's software, each reduced baseline will contain various orientation parameters, covariance matrices, and cofactor and/or correlation statistics that may be used in weighting the final network adjustment. Most least-squares adjustments use the accuracy or correlation statistics from the baseline reductions; however, other weighting methods may be used in a least-squares or approximate adjustment.

c. The adjustment technique employed (and time devoted to it) must be commensurate with the intended accuracy of the survey, as defined by the project's engineering and construction requirements. Care must be taken to prevent the adjustment process from becoming a project in itself.

d. There is no specific requirement that a rigorous least-squares type of adjustment be performed on USACE surveys, whether conventional, GPS, or mixed observations. Traditional approximate adjustment methods may be used in lieu of least-squares, and will provide comparable practical accuracy results.

e. Commercial software packages designed for higher-order geodetic densification surveys often contain a degree of statistical sophistication that is unnecessary for engineering survey control densification. For example, performing repeated Chi-square statistical testing on observed data intended for 1:20,000 base mapping photogrammetric control may be academically precise but, from a practical engineering standpoint, is inappropriate. The distinction between geodetic surveying and engineering surveying must be fully considered when performing GPS survey adjustments and analyzing the results thereof.

f. The advent of GPS surveying technology has provided a cost-effective means of tying previously poorly connected USACE projects to the NGRS, and simultaneously transforming the project to the newly defined NAD 83. In performing (adjusting) these connections, care must be taken not to

distort or warp long-established project construction/boundary reference points. Connections and adjustments to existing control networks, such as the NGRS, must not become independent projects. It is far more important to establish dense and accurate local project control than to consume resources tying into high-order NGRS points miles from the project. Engineering, construction, and property/boundary referencing requires consistent local control with high relative accuracies; accurate connections/references to distant geodetic datums are of secondary importance. (Exceptions might involve projects in support of military operations.)

11-3. GPS Error Measurement Statistics

In order to understand the adjustment results of a GPS survey network (or any network containing GPS, angle, distance, and/or elevation observations), some simple statistical terms should be fully understood. Many of these terms have varying names in different commercial software adjustment packages, as indicated below.

- *Accuracy.* Accuracy is the how well a measurement or a group of measurements are in relation to a "true" or "known" value.
- *Precision.* Precision is how close a group or sample of measurements are to each other or their mean. For example, a low standard deviation indicates high precision. It is important to understand that a survey or group of measurements can have a high precision, but have a low accuracy (i.e. measurements are close together but not close to the known or true value).
- *Standard deviation.* Also termed "standard error." The standard deviation is a range of how close the measured values are from the arithmetic average. A low standard deviation indicates that the observations or measurements are close together. Standard deviation is computed by taking the square root of the variance. *A priori* observation weights are inversely proportional to the estimated variance. A large weight implies a small variance or standard deviation. Deviations can be reported at different confidence levels--e.g., 67%, 95%.
- *A priori weighting.* The initial weighting assigned to an observation. The *a priori* weight is based on past experience of resultant accuracies in network adjustments, or from manufacturer's estimates. For example, past adjustment results from a certain total station indicate it can measure angles to an accuracy of ± 7 arc-seconds ($1-\sigma$). The *a priori* weighting used in subsequent adjustments would be $1/(7^2)$, or 0.02. (Weights are inversely proportional to the variance). Weights from independent observations are usually uncorrelated. However, they may be correlated, as is the case with GPS baseline vector components.
- *Least-squares adjustment.* One of the most widely used methods for adjusting geodetic and photogrammetric surveys. Least-squares adjustments provide a structured approach as opposed to approximate adjustment techniques. The principle of least-squares is simply:

$$\sum [\mathbf{V}^T \mathbf{P} \mathbf{V}] \rightarrow \text{minimum}$$

where \mathbf{V} is the matrix of the residuals (\mathbf{V}^T is the transpose of \mathbf{V})
 \mathbf{P} is the "weight" matrix of the observations

If there are " n " observations, then there will be " n " residuals (v) and the weight matrix will be " $n \times n$ " square, containing variations within, and correlations between, the individual observations.

- *Residual.* Difference between a computed (i.e. adjusted) and observed quantity ... often designated as "(c-o)" for "computed minus observed". The residual for a single observation is symbolized as " v " or, for a group of " n " observations, " \mathbf{V} " is a [$n \times 1$] column matrix. The computed value typically is output from a least-squares adjustment. From this adjusted value the original observation is subtracted to obtain the residual.
- *Standardized or Normalized residual.* Allows for a consistent evaluation of different types of observations (GPS 3-D baseline vectors, angles, EDM distances, elevation differences, etc.) in order to flag potential outlier observations. For each observation, most commercial adjustment software lists the resultant residuals in their original units (meters, degrees, etc.) and then "normalizes" these residuals by multiplying the residual " v " by the square root of the input weight of the observation (or by the adjusted standard error of the observation).

$$\text{Normalized or standardized residual} = v / \sigma = v \cdot \sqrt{w}$$

$$\text{where the "weight" } w = 1/(\sigma^2)$$

Normalized residuals are unitless. Some software (e.g., Trimble Geomatics Office) use normalized residuals to plot histograms that depict the relative magnitude of the distribution of the residuals, from which outlier tests (i.e. Student "t" or "Tau") can be performed.

- *Covariance matrix.* Also termed the "variance-covariance matrix." Usually designated by the term " \mathbf{S} ". The covariance matrix contains variance elements for a three-dimensional vector or observation, such as a GPS baseline. A GPS baseline covariance matrix contains the variances and correlations in all three dimensions. It is typically output from the baseline reduction software and input into a least-squares network adjustment for use in forming *a priori* weight factors. Covariance matrices are also generated for all points and lines in a free or constrained network adjustment. Covariance matrices contain the parameters needed to portray 1-D estimated errors, 2-D error ellipses, or 3-D error ellipsoids, and include the parameters needed to compute related RMS and confidence level statistics.
- *Degrees of Freedom.* Typically designated by the symbol " r ." Simply, the number of redundant observations in an adjustment, which, in turn, is a function of the number of conditions and unknowns in the network.
- *Variance of Unit Weight.* Also termed "reference variance" or "variance factor." Usually designated by the symbol " s_0^2 " and is computed from:

$$s_0^2 = \mathbf{V}^T \mathbf{P} \mathbf{V} / r$$

where r = the degrees of freedom

This statistic is important in evaluating the results of an adjustment. It represents the overall ratio of variance of all the residuals in a network adjustment relative to the *a priori* variance estimate. It is used for testing *a priori* weighting estimates of the observations relative to the actual variations resulting in the least-squares adjustment. Reference variances around 1.0

indicate the observations conformed to the nominal estimated accuracy. Large reference variances typically indicate one or more poor observations in the adjustment.

- *Standard error of unit weight.* The square root of the "Variance of Unit Weight" is termed the "reference standard deviation," "reference factor," or "standard error of unit weight."
- *Chi-square test.* Statistical hypothesis test on the computed reference variance in a network of observations relative to the *a priori* estimate; for a given level of significance (e.g., 95%) and degrees of freedom. Chi-square is computed directly from the residuals and weights in the least-squares adjustment and an assumed *a priori* reference variance. Many commercial software packages use the Tau criterion test, which is derived from a standard Student *t*-distribution, and is used to test the statistical significance of outliers in the residuals.
- *Error ellipse.* Graphical depiction of a point's geometric accuracy and alignment. Relative accuracy ellipses may also be shown for GPS baseline distances. Error ellipses are normally plotted at the 95% confidence level, meaning a 95% probability exists that the resultant adjusted point falls within the dimensions of the ellipse. Two and three-dimensional ellipsoids of constant probability may be output in an adjustment.
- *Root mean square (RMS).* Also termed "mean square error." In one dimension (e.g., X, Y, or Z) RMS is equivalent to standard deviation. In two dimensions, RMS is a radial measure approximating the probability of an error ellipse. RMS is usually stated at the 95% probability level. RMS may include both random and systematic errors.
- *Free or Minimally Constrained network adjustment.* Also termed "internal adjustment." A free network adjustment normally holds only one point fixed, which allows assessment of all the observations. Distinctions between "free" and "minimally constrained" adjustments are made by some software vendors.
- *Constrained Adjustment.* Also termed "external adjustments." A constrained adjustment holds two or more points, azimuths, scales, etc. fixed and constrains all the observations to these fixed values. Constrained points may be held rigid or may be weighted.

For further information on the principles and theory of least-squares adjustments, and the statistics resulting from these adjustments, consult Leick 1995 or Mikhail 1976. For more practical discussions on these statistical concepts, see Trimble 2001c (*Trimble Geomatics Office--Network Adjustment Software User Guide*).

11-4. Survey Adjustments and Accuracy

GPS-performed surveys are usually adjusted and analyzed relative to their internal consistency and external fit with existing control. The internal consistency adjustment (i.e. free or minimally constrained adjustment) is important from a contract compliance standpoint. A contractor's performance should be evaluated relative to this adjustment. The final, or constrained, adjustment fits the GPS survey to the existing network. This is not always easily accomplished since existing networks often have lower relative accuracies than the GPS observations being fit. Evaluation of a survey's adequacy should not be based solely on the results of a constrained adjustment.

a. General. The accuracy of a survey (whether performed using conventional or GPS methods) is a measure of the difference between observed values and the true values (coordinates, distances, angles,

etc.). Since the true values are rarely known, only estimates of survey accuracy can be made. These estimates may be based on the internal observation closures, such as on a loop traverse, or connections with previously surveyed points assumed to have some degree of reliability. The latter case is typically a traverse (GPS or conventional) between two previously established points, either existing USACE project control or the published NGRS network.

(1) GPS internal accuracies are typically far superior to most previously established control networks. Therefore, determining the accuracy of a GPS survey based on misclosures with external points is not always valid unless statistical accuracy estimates (i.e. station variance-covariance matrices, distance/azimuth relative accuracy estimates, etc.) from the external network's original adjustment are incorporated into the closure analysis for the new GPS work. Such geodetic refinements are usually unwarranted for most USACE work.

(2) Most survey specifications and standards (including USACE) classify accuracy as a function of the resultant relative accuracy between two adjacent points in a network. This resultant accuracy is estimated from the statistics in an adjustment, and is defined by the size of a 2-D or 3-D relative error ellipse formed between the two points. Relative distance, azimuth, or elevation accuracy specifications and classifications are derived from this model, and are expressed either in absolute values (e.g., ± 1.2 cm) or as ratios of the propagated standard errors to the overall length (e.g., 1:20,000).

b. Internal accuracy. A loop traverse originating and ending from a single point will have a misclosure when observations (i.e. EDM traverse angles/distances or GPS baseline vectors) are computed forward around the loop back to the starting point. The forward-computed misclosure provides an estimate of the relative or internal accuracy of the observations in the traverse loop, or more correctly, the internal precision of the survey. This is perhaps the simplest method of evaluating the adequacy of a survey, and most commercial GPS adjustment software contains loop closure checks. These loop point misclosures, either expressed as distances or ratios, are not the same as relative distance accuracy measures.

(1) Internal accuracy estimates made relative to a single fixed point are obtained when so-called free, unconstrained, or minimally constrained adjustments are performed. In the case of a single loop, no redundant observations (or alternate loops) back to the fixed point are available. When a series of GPS baseline loops (or network) are observed, then the various paths back to the single fixed point provide multiple position computations, allowing for a statistical analysis of the internal accuracy of not only the position closure but also the relative accuracies of the individual points in the network (including relative distance and azimuth accuracy estimates between these points). The magnitude of these internal relative accuracy estimates (on a free adjustment) determines the adequacy of the control for subsequent design, construction, and mapping work.

(2) Loop traverses are discouraged for most conventional surveys due to potential systematic distance (scale) or orientation errors that can be carried through the network undetected. FGDC classification standards for geodetic surveys do not allow traverses to start and terminate at a single point. Such procedures are unacceptable for incorporation into the NGRS network; however, due to many factors (primarily economic), loop traverses or open-ended spur lines are commonly employed in densifying project control for engineering and construction projects. Since such control is not intended for inclusion in the NGRS and usually covers limited project ranges, such practices have been acceptable. Loop traverses will also be acceptable for GPS surveys performed in support of similar engineering and construction activities.

c. External accuracy. The coordinates (and reference orientation) of the single fixed starting point will also have some degree of accuracy relative to the network in which it is located, such as the

NGRS, if it was established relative to that system/datum. This "external" accuracy (or inaccuracy) is carried forward in the traverse loop or network; however, any such external variance (if small) is generally not critical to engineering and construction. When a survey is conducted relative to two or more points on an existing reference network, such as USACE project control or the NGRS, misclosures with these fixed control points provide an estimate of the "absolute" accuracy of the survey. This analysis is usually obtained from a final adjustment, such as a fully constrained least-squares minimization technique or by other recognized traverse adjustment methods (Transit, Compass, Crandall, etc.).

d. NGRS versus local project control. Classical geodetic surveying is largely concerned with absolute accuracy, or the best-fitting of intermediate surveys between points on a national network, such as the NGRS. Alternatively, in engineering and construction surveying, and to a major extent in boundary surveying, relative, or local, accuracies are more critical to the project at hand. As was outlined in Chapter 8, the absolute NAD 27 or NAD 83 coordinates (in latitude and longitude) relative to the NGRS datum reference are of less importance; however, accurate relative coordinates over a given project reach (channel, construction site, levee section, etc.) are critical to design and construction. This absolute accuracy estimate assumes that the fixed (existing) control is superior to the survey being performed, and that any position misclosures at connecting points are due to internal observational errors and not the existing control. This has always been a long-established and practical assumption, and has considerable legal basis in property/boundary surveying. New work is rigidly adjusted to existing control regardless of known or unknown deficiencies in the fixed network.

(1) For example, in establishing basic mapping and construction layout control for a military installation, developing a dense and accurate internal (or relative) control network is far more important than the values of these coordinates relative to the NGRS.

(2) On flood control and river and harbor navigation projects, defining channel points must be accurately referenced to nearby shore-based control points. These points, in turn, directly reference boundary/right-of-way points and are also used for dredge/construction control. Absolute coordinates (NGRS/NAD 83) of these construction and/or boundary reference points are of less importance.

(3) Although reference connections with the NGRS are desirable and recommended, and should be performed where feasible and practicable, it is critical that such connections (and subsequent adjustments thereto) do not distort the internal (relative) accuracy of intermediate points from which design, construction, and/or project boundaries are referenced.

(4) Connections and adjustments to distant networks (i.e. NGRS) can result in mixed datums within a project area, especially if not all existing project control has been tied in. This in turn can lead to errors and contract disputes during both design and construction. On existing projects with long-established reference control, connections and adjustments to outside reference datums/networks should be performed with caution. The impacts on legal property and project alignment definitions must also be considered prior to such connections.

(5) On newly authorized projects, or on projects where existing project control has been largely destroyed, reconnection with the NGRS is highly recommended. This will ensure future work will be supported by a reliable and consistent basic network, while minimizing errors associated with mixed datums.

(6) Since the relative positional accuracies of points on the NGRS are known from the NAD 83 readjustment, and GPS baseline vector accuracy estimates are obtained from the individual reductions, variations in misclosures in GPS surveys are not always due totally to errors in the GPS work. Forcing a

GPS traverse/network to rigidly fit the existing (fixed) network usually results in a degradation of the internal accuracy of the GPS survey, as compared with a free (unconstrained) adjustment.

11-5. Free or Minimally Constrained Adjustments

This adjustment is made to determine how well the baseline observations fit or internally close within themselves. This adjustment provides a measure of the internal precision of the survey. If a network of GPS and terrestrial observations is minimally constrained, internal observation errors can be assessed independent of external control points. The minimally constrained adjustment is performed to find and remove poor quality observations (outliers). It also may be used to readjust the *a priori* weights for each observation (or types of observations) should the adjustment results indicate that the estimated weights were inaccurate. The flexibility to perform these adjustments depends on the software used. Other terrestrial EDM distances or angles may also be included in the adjustment.

a. In a simplified example, a conventional EDM traverse that is looped back to the starting point will misclose in both azimuth and position, as shown in Figure 11-1. Classical "approximate" adjustment techniques (e.g., Transit, Compass, Bowditch, Crandall, etc.) will typically assess the azimuth misclosure, proportionately adjust the azimuth misclosure (usually evenly per station), recompute the traverse with the adjusted azimuths, and obtain a position misclosure. This position misclosure (in X and Y) is then distributed among all the points on the traverse using various weighting methods (distance, latitudes, departures, etc.). Final adjusted azimuths and distances are then computed from grid inverses between the adjusted points. The adequacy/accuracy of such a traverse is evaluated based on the azimuth misclosure and position misclosure after azimuth adjustment (usually expressed as a ratio to the overall length of the traverse).

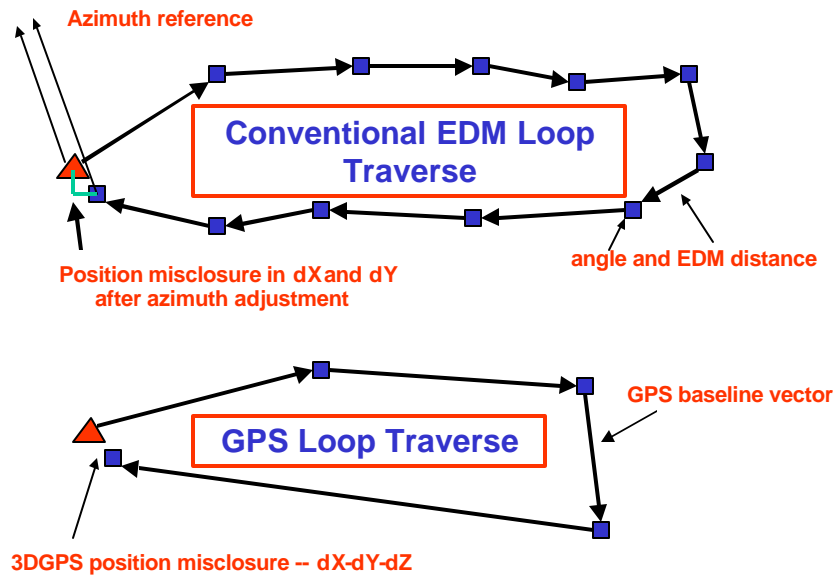

Figure 11-1. Conventional EDM and GPS traverse loops

b. A least-squares adjustment of the same conventional loop traverse will end up adjusting the points similarly to the approximate methods traditionally employed. The only difference is that a least-squares adjustment simultaneously adjusts both observed angles (or directions) and distance measurements. A least-squares adjustment also allows variable weighting to be set for individual angle/distance observations, which is a somewhat more complex process when approximate adjustments are performed. In addition, a least-squares adjustment will yield more definitive statistical results of the internal accuracies of each observation and/or point, rather than just the final closure. This includes estimates of the accuracies of individual station X-Y coordinates, relative azimuth accuracies, and relative distance accuracies.

c. A series of GPS baselines forming a loop off a single point can be adjusted and assessed similarly to a conventional EDM traverse loop described above (Figure 11-1). The baseline vector components may be computed (accumulated) around the loop with a resultant three-dimensional misclosure back at the starting point. These misclosures (in X, Y, and Z) may be adjusted using either approximate or least-squares methods. The method by which the misclosure is distributed among the intermediate points in the traverse is a function of the adjustment weighting technique.

(1) In the case of a simple EDM traverse adjustment, the observed distances (or position corrections) are weighted as a function of the segment length and the overall traverse length (Compass Rule), or to the overall sum of the latitudes/departures (Transit Rule). Two-dimensional EDM distance observations are not dependent on their direction; that is, a distance's X- and Y-components are uncorrelated.

(2) GPS baseline vector components (in X, Y, and Z) are correlated due to the geometry of the satellite solution; that is, the direction of the baseline vector is significant. Since the satellite geometry is continuously changing, remeasured baselines will have different correlations between the vector components. Such data are passed down from the baseline reduction software for use in the adjustment.

d. The magnitude of the misclosure (i.e. loop closure) of the GPS baseline vectors at the initial point provides an estimate of the internal precision or geometric consistency of the loop (survey). When this misclosure is divided by the overall length of the baselines, an internal relative accuracy estimate results. For example, if the position misclosure of a GPS loop is 0.08 m and the length of the loop is 8,000 m, then the loop closure is $0.08/8,000$ or 1 part in 100,000 (1:100,000). This misclosure ratio should not be less than the relative distance accuracy classification intended for the survey.

e. When an adjustment is performed, the individual corrections/adjustments made to each baseline--the residual errors--provide an accuracy assessment for each baseline segment. A least-squares adjustment can additionally provide relative distance accuracy estimates for each line, based on standard error propagations between adjusted points. This relative distance accuracy estimate is most critical to USACE engineering and construction work, and represents the primary basis for assessing the acceptability of a survey.

11-6. Fully Constrained Adjustments

The internal "free" geometric adjustment provides adjusted positions relative to a single, often arbitrary, fixed point. Most surveys (conventional or GPS) are connected between existing stations on some predefined reference network or datum. These fixed stations may be existing project control points (on NAD 27--SPCS 27) or stations on the NGRS (NAD 83). In OCONUS locales, other local or regional reference systems may be used. A constrained adjustment is the process used to best fit the survey observations to the established reference system.

a. A simple conventional EDM traverse (Figure 11-2) between two fixed stations best illustrates the process by which comparable GPS baseline vectors are adjusted. The misclosure in azimuth and position between the two fixed end points may be adjusted by any type of approximate or least-squares adjustment method. Unlike a loop traverse, however, the azimuth and position misclosures are not wholly dependent on the internal errors in the traverse--the fixed points and their azimuth references are not absolute, but contain relative inaccuracies with respect to one another.

b. A GPS survey between the same two fixed points also contains a 3-D position misclosure. Due to positional uncertainties in the two fixed network points, this misclosure may (and usually does) far exceed the internal accuracy of the raw GPS observations. As with a conventional EDM traverse, the 3-D misclosures may be approximately adjusted by proportionately distributing them over the intermediate points. A least-squares adjustment will also accomplish the same thing.

c. If the GPS survey is looped back to the initial point, the free adjustment misclosure at the initial point may be compared with the apparent position misclosure with the other fixed point. In Figure 11-2, the free adjustment loop misclosure is 0.2 ft or 1:100,000, whereas the 2-ft misclosure relative to the two network control points is only 1:5,000. Thus, the internal relative accuracy of the GPS survey is on the order of 1 part in 100,000 (based on the misclosure); if the GPS baseline observations are constrained to fit the existing control, the 2-ft external misclosure must be distributed amongst the individual baselines to force a fit between the two end points.

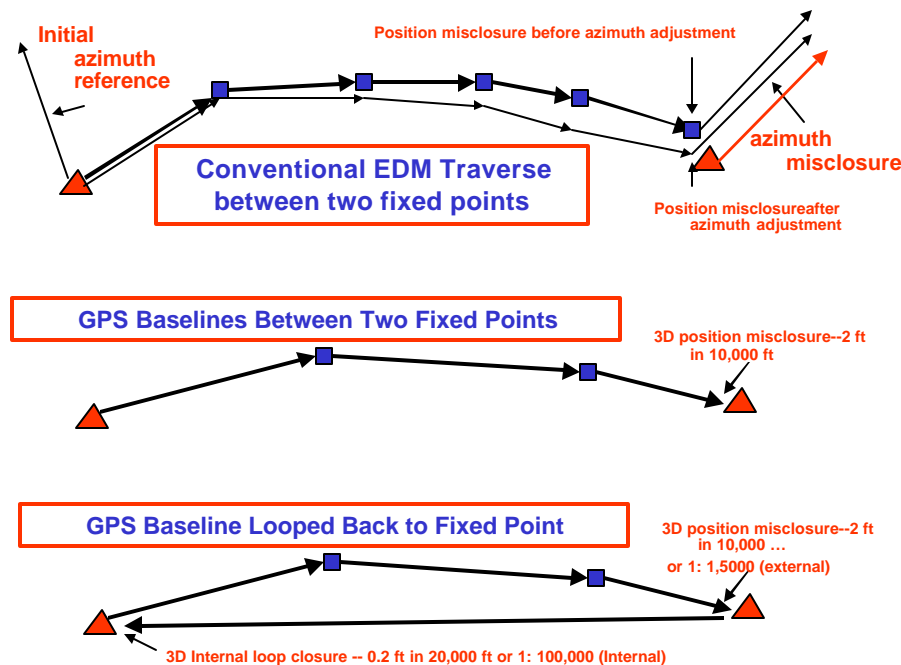

Figure 11-2. Constrained adjustments between two fixed points

(1) After a constrained adjustment, the absolute position misclosure of 2 ft causes the relative distance accuracies between individual points to degrade. They will be somewhat better than 1:5,000 but far less than 1:100,000. The statistical results from a constrained least-squares adjustment will provide estimates of the relative accuracies between individual points on the traverse.

(2) This example also illustrates the advantages of measuring the baseline between fixed network points when performing GPS surveys, especially when weak control is suspected (as in this example).

(3) Also illustrated is the need for making additional ties to the existing network. In this example, one of the two fixed network points may have been poorly controlled when it was originally established, or the two points may have been established from independent networks (i.e. were never connected). A third or even fourth fixed point would be beneficial in resolving such a case.

d. If the intent of the survey shown in Figure 11-2 was to establish 1:20,000 relative accuracy control, connecting between these two points obviously will not provide that accuracy given the amount of adjustment that must be applied to force a fit. For example, if one of the individual baseline vectors was measured at 600 m and the constrained adjustment applied a 0.09 m correction in this sector, the relative accuracy of this segment would be roughly 1:6,666. This distortion would not be acceptable for subsequent design/construction work performed in this area.

e. Most GPS survey networks are more complex than the simple traverse example in Figure 11-2. They may consist of multiple loops and may connect with any number of control points on the existing network. In addition, conventional EDM, angles, and differential leveling measurements may be included with the GPS baselines, resulting in a complex network with many adjustment conditions.

11-7. Partially Constrained Adjustments

In the previous example of the simple GPS traverse, holding the two network points rigidly fixed caused an adverse degradation in the GPS survey, based on the differences between the free (loop) adjustment and the fully constrained adjustment. An alternative is to perform a semi-constrained (or partially constrained) adjustment of the net. In a partially constrained adjustment, the two network points are not rigidly fixed but only partially fixed in position. The degree to which the existing network points are constrained may be based on their estimated relative accuracies or, if available, their original adjustment positional accuracies (covariance matrices). Partially constrained adjustments are not practicable using approximate adjustment techniques; only least-squares will suffice.

a. For example, if the relative distance accuracy between the two fixed network points in Figure 11-2 is approximately 1:10,000, this can be equated to a positional uncertainty between them. Depending on the type and capabilities of the least-squares adjustment software, the higher accuracy GPS baseline observations can be "best fit" between the two end points such that the end points of the GPS network are not rigidly constrained to the two original control points but will end up falling near them.

b. Some (but not all) commercial adjustment software will allow relative weighting of the fixed points to provide a partially constrained adjustment. Any number of fixed points can be connected to, and these points may be given partial constraints in the adjustment. Fixed control points are partially constrained by setting the standard error to varying amounts. A large standard error (i.e. low relative weight) would be set for uncertain accuracy points. A small standard error would be set for high accuracy points, such as a published NGRS point or First-Order level line benchmark. To effectively fix a rigid point in a network, its standard error can be set extremely low--e.g., ± 0.01 mm.

c. Performing partially constrained adjustments (as opposed to a fully constrained adjustment) takes advantage of the inherent higher accuracy GPS data relative to the existing network control, which is traditionally weak on many USACE project areas. Less warping of the GPS data (due to poor existing networks) will then occur.

d. A partial constraint also lessens the need for performing numerous trial-and-error constrained adjustments in attempts to locate the poor external control points that are causing high residuals. Fewer ties to the existing network need be made if the purpose of such ties was to find a best fit on a fully constrained adjustment.

e. When connections are made to the NAD 83 or NAVD 88, relative accuracy estimates of NGRS stations can be obtained from the NGS. Depending on the type of adjustment software used, these partial constraints may be in the form of variance-covariance matrices, error ellipses, or circular accuracy estimates.

11-8. Rigorous Least-Squares Adjustments of GPS Surveys

Adjustment of survey networks containing GPS baselines and/or conventional observations is typically a trial-and-error process for both the free (minimally constrained) and fully constrained adjustments. A generalized flow for performing the adjustment is shown in Figure 11-3. Once the baselines have been reduced and meet acceptable criteria, then the "free" or "minimally constrained" adjustment is performed, holding one point fixed. Individual network observations may be reweighted during this phase. The next step is to include all the fixed-point constraints in a network and perform the "fully constrained" adjustment. These "fixed" points may be partially or fully constrained, depending on their estimated accuracy. Adjustments are performed on the project's horizontal and vertical datums. This requires transforms from the satellite-based WGS 84 earth-centered, earth-fixed, geocentric coordinates. Typically, transforms are performed from WGS 84 to NAD 83 or NAD 27 horizontal systems, and to a local vertical network that may be based on NGVD 29, NAVD 88, or some other local vertical datum. Geoid models may also be added to the adjustment. Performing these accurate datum transforms is critical. Final adjusted coordinates are output, along with relative accuracies.

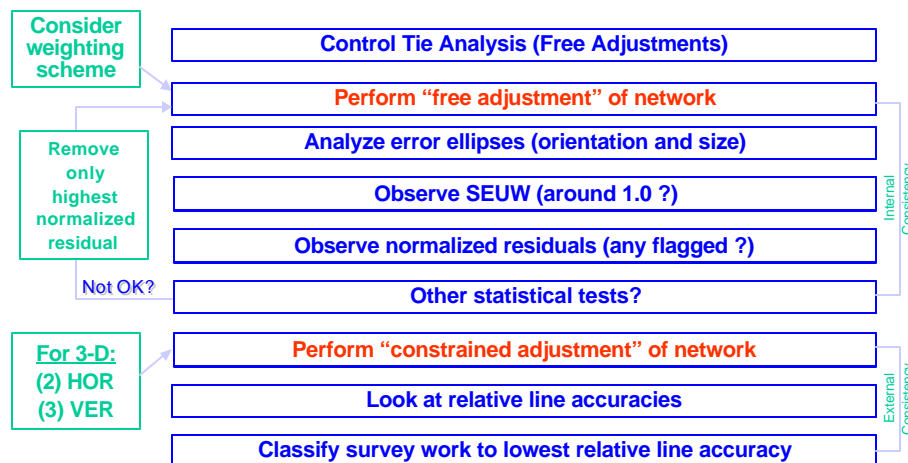

Figure 11-3. Sequential flow of a GPS network adjustment

The following is a summary of a network adjustment sequence recommended by NGS for surveys that are connected to the NGRS:

- A minimally constrained 3-D adjustment is done initially as a tool to validate the data, check for blunders and systematic errors, and to look at the internal consistency of the network.
- A 3-D horizontal constrained adjustment is performed holding all previously published horizontal control points fixed and one height constraint. If the fit is poor, then a readjustment is considered. All previous observations determining the readjusted stations are considered in the adjustment.
- A fully constrained vertical adjustment is done to determine the orthometric heights. All previously published benchmark elevations are held fixed along with one horizontal position in a 3-D adjustment. Geoid heights are predicted using the latest model.
- A final free adjustment to obtain final accuracy estimates using the rescaled variance factor from the fully constrained adjustment.

The last step is usually not applicable to Corps projects since few points are established for incorporation in the national network. The above sequence used by NGS differs somewhat with adjustment techniques recommended by other commercial software vendors. For example, some recommend that the constrained adjustment be performed by sequentially adding fixed control points. Other variations also exist. For most engineering and construction work, many of the sophisticated adjustment procedures and techniques are not relevant to the project accuracy requirements.

11-9. Network Adjustment Software Used in Corps

A number of commercial and government least-squares adjustment software packages are available that will adjust GPS networks using standard desktop or laptop computers. Those commonly used by USACE Commands include the following:

- "ADJUST," an adjustment program distributed by the National Geodetic Survey.
- "Ashtech Solutions," distributed by Thales Navigation LTD.
- "GeoLab," distributed by Microsearch, Inc.
- "GPSurvey," distributed by Trimble Navigation LTD.
- "GrafNav/GrafNet," distributed by Waypoint Consulting Inc.
- "SKI Pro," distributed by Leica Geosystems, Inc.
- "STAR*NET, STAR*NET PRO, and STAR*LEV," distributed by Starplus Software, Inc.
- "Trimble Geomatics Office (TGO)," distributed by Trimble Navigation LTD.

The above software packages have varying applications in USACE. Some are more applicable to traditional static or kinematic GPS surveys and others allow incorporation of terrestrial observations and GPS observations. Some are designed to support airborne GPS (ABGPS) control where velocity and inertial measurement units (IMU) are included. USACE commands selecting network adjustment

software need to evaluate many factors, including cost, which varies if mixed terrestrial and GPS adjustments are opted and baseline reduction is included. As a result, costs can vary widely--from \$1,000 to over \$15,000. Complexity of the software is also a consideration. Some software is designed to support high-order geodetic network adjustments and may be overly complex for engineering and construction surveys. In general, all these packages perform a standard least-squares adjustment; however, adjustment algorithms, weighting strategies, and statistical terminology can vary among vendors. As a result, identical input data may yield slightly different results when run through different adjustment software. In general, using baseline reduction and adjustment software developed by the same GPS receiver/data collector manufacturer is the best approach if a District has identical receivers; however, there are exceptions. To help in evaluating adjustment software, sample adjustment output from some vendors are given throughout this chapter and in various appendices attached to this manual. Many of these examples contain annotations explaining input and output parameters specific to the software. Trade publications (e.g., "*Point of Beginning--POB*") periodically publish comparisons between different adjustment software systems. These comparisons can also be of value in evaluating which adjustment software best meets an application.

11-10. Network Adjustment Criteria

When a least-squares adjustment is performed on a network of GPS observations, most adjustment software will provide the adjusted 2-D or 3-D coordinate data, positional accuracy estimates of adjusted points, covariance matrix (error ellipse) data for the adjusted coordinates, and related baseline covariance data between adjusted points (i.e. relative line distance and azimuth accuracy estimates). Analyzing these various statistics is not always simple. These statistics are also easily misinterpreted given the varied weighting and confidence interval options. Arbitrary rejection and readjustment in order to obtain a best fit (or best statistics) must be avoided. The original data reject criteria must be established and justified in a final report document. Recommended criteria that should be followed are summarized in Table 11-1 and more fully explained in subsequent sections of this chapter.

Table 11-1. Free and Constrained Least-Squares Network Adjustment Criteria

Criterion	
Evaluation statistic on free/unconstrained adjustment	relative distance accuracies
Error ellipse size	95%
Reject Criteria:	
Statistic	normalized residual
Standard	± 3 times standard error of unit weight
Optimum/Nominal Weighting:	± 2 cm + 2 ppm
Optimum Variance of Unit Weight (Free Adjustment)	between 0.5 and 1.5
Allowable Variance of Unit Weight (Free Adjustment)	between 2.0 and 10
Allowable Variance of Unit Weight (Constrained Adjustment)	no specific criteria

11-11. Baseline Weights--Covariance Matrix

Baseline reduction vector component error statistics are usually carried down into the least-squares adjustment and used for relative weighting of the observations. Relative GPS baseline standard errors can be obtained from the baseline reduction output and in some software can be directly input into the adjustment. These standard errors, along with their correlations, are given for each vector component (in geocentric ΔX , ΔY , and ΔZ). They are converted to relative weights in the adjustment. A typical baseline vector and covariance matrix input (from GrafNet) is shown below:

SESSION NAME	VECTOR(m)			----- Covariance (m) [unscaled] -----		
	DX/DY/DZ			standard deviations in (parens)		
2 to 7 (1)	22054.8259	2.9600e-005		(0.0054)		
	-11419.0806	5.0662e-005		1.1843e-004	(0.0109)	
	-4620.2154	-3.8191e-005		-8.5945e-005	7.7102e-005	(0.0088)

The above baseline contains the 3-D geocentric coordinate vectors, along with the covariance matrix variance (standard deviation) and correlation values. These values are then used as input and weighting in the subsequent adjustment. The default *a priori* standard errors in an adjustment package have been found to be reasonable in standard USACE work where extremely long baselines are not involved. Use of these optimum values is recommended for the first adjustment iteration. If the network also contains terrestrial observations (differential leveling, total station, etc.) then each of these observations must be properly weighted. Most software provides recommended guidance for weighting conventional leveling, angle, and distance observations. For many lower-order engineering surveys, least-squares adjustments can be performed without all the covariance and correlation statistics from the GPS baseline reduction. The following is a listing of default Standard errors (i.e. weights) for GPS and terrestrial observations used by Star*Net 6.0, a comprehensive adjustment program that handles mixed observations. These standard errors can be easily modified to reflect local conditions or experience. Star*Net recommends scaling GPS vectors by 8.0, to reflect over-optimistic weighting from baseline reduction software. For this sample project, the geoid height (-31.2000 m) was assumed constant over the entire area. Alternatively, a geoid model could have been input.

Project Option Settings (from STAR*NET 6.0 Demonstration Program)

```

STAR*NET Run Mode           : Adjust with Error Propagation
Type of Adjustment         : 3D
Project Units               : Meters; DMS
Coordinate System          : Mercator NAD83; AZ Central 0202
Geoid Height               : -31.2000 (Default, Meters)
Longitude Sign Convention  : Positive West
Input/Output Coordinate Order : North-East
Angle Data Station Order   : At-From-To
Distance/Vertical Data Type : Slope/Zenith
Convergence Limit; Max Iterations : 0.001000; 10
Default Coefficient of Refraction : 0.070000
Create Coordinate File     : Yes
Create Geodetic Position File : Yes
Create Ground Scale Coordinate File : No
Create Dump File          : No
GPS Vector Standard Error Factors : 8.0000
GPS Vector Centering (Meters) : 0.00200
GPS Vector Transformations : Solve for Scale and Rotations
  
```

GPS Vector scaling and
estimated centering error

Instrument Standard Error Settings

```

Project Default Instrument
Distances (Constant)      : 0.007500 Meters
Distances (PPM)           : 2.000000
Angles                    : 0.500000 Seconds
Directions                : 1.000000 Seconds
Azimuths & Bearings       : 1.000000 Seconds
Zeniths                   : 3.000000 Seconds
Elevation Differences (Constant) : 0.010000 Meters
Elevation Differences (PPM) : 0.000000
Differential Levels       : 0.002403 Meters / Km
Centering Error Instrument : 0.002000 Meters
Centering Error Target    : 0.002000 Meters
Centering Error Vertical  : 0.000000 Meters
  
```

Terrestrial Observation Weighting

a. *Variance factor.* The adequacy of the initial network *a priori* weighting described above is indicated by the variance of unit weight, which equals the square of the standard error of unit weight. The variance of unit weight should range between 0.5 and 1.5 (or the standard error of unit weight should range between 0.7 and 1.2), with an optimum value of 1.0 signifying realistic weighting of the GPS input observations. A large unit variance (say 5.0) indicates the initial GPS standard errors were too optimistic (low) or, more likely, some poor observations are present. A low unit variance (say 0.1) indicates the results from the adjustment were better than the assumed GPS baseline precisions used. This unit variance test is, however, generally valid only when a statistically significant number of observations are involved. This is a function of the number of "degrees of freedom" shown on the adjustment. To evaluate the adequacy of the unit weight, a test such as Chi-square is performed. Failure of such a test indicates the variance factor statistic may not be statistically valid, including any rejections made using this value.

b. *Changing weight factors.* In performing a free adjustment, the input (*a priori*) standard errors can easily be "juggled" in order to obtain a variance of unit weight near 1.0. This trial-and-error method is generally not a good practice--especially if observational blunders are present. If the input weights are changed, they should not be modified beyond reasonable levels (e.g., do not input a GPS standard error of

$\pm 50 \text{ cm} + 50 \text{ ppm}$ in order to get a good unit variance). If input standard errors are modified, these modifications should be the same for all lines, not just selected ones. Any such modifications of *a priori* standard errors must be justified and explained in the adjustment report.

c. Rescaling the variance of unit weight. Some software allows rescaling of the entire network with the initial variance of unit weight, with a new resultant 1.0 variance factor. Changing the magnitude of the input standard errors/weights will not change the adjusted position or residual results in a free adjustment provided all weight changes are made equally--i.e. the entire project is rescaled. Although the reference variance will change, the resultant precisions (relative line accuracies) will not change. (This is not true in a constrained adjustment.) Therefore, the internal accuracy of a survey can be assessed based on the free adjustment line accuracies regardless of the initial weighting or variance of unit weight.

11-12. Adjustment Output Statistics

Least-squares adjustment software will output various statistics from the free adjustment to assist in detecting blunders and residual outliers in the free adjustment. Most commercial packages will display the normalized residual for each observation (GPS, EDM, angle, elevation, etc.), which is useful in detecting and rejecting residual outliers. The variance of unit weight (or its square root--the Standard Error of Unit Weight) is important in evaluating the overall adequacy of the observed network. The initial variance of unit weight on the first free adjustment is often input to rescale the weighting for a second free adjustment, providing more representative error statistics with a unity variance of unit weight. Other statistics, such as Tau, Chi-square, histograms, etc., are useful in assessing (or statistically testing) outlier data for potential reject. These statistical tests may or may not be significant for lower-order USACE engineering projects, and become totally insignificant if one is not well versed in statistics and adjustment theory. Use of these statistics to reject data (or in reporting results of an adjustment) without a full understanding of their derivation and source within the network adjustment is ill-advised.

11-13. Minimally Constrained Adjustment Considerations

The "free" adjustment is probably the most important phase of reducing and evaluating survey data--especially when redundant observations are involved. When a series of observation loops are formed relative to a fixed point or off another loop, different redundant conditions are formed. These different loops allow forward baseline vector position computations to be made over different paths. From the different routes (loops) formed, different positional closures at a single fixed point result. These variances in position misclosures from the different routes provide additional data for assessing the internal consistency of the network, in addition to checking for blunders in the individual baselines. The number of different paths, or conditions, is partially related to the number of degrees of freedom in the network. Since a "free" adjustment only holds one arbitrary point fixed (in position and orientation), the resultant adjustment will provide a clean analysis of the internal consistency of the observations in the network. Performing a free adjustment on a complex network containing many redundancies is best performed using least-squares methods. An example of such a network is shown in Figure 11-4. Approximate adjustment methods are difficult to evaluate when complex interweaving networks are involved.

a. Redundant baseline observations. Duplicate baseline observations also provide additional redundancy or strength to a line or network since they are observed at two distinct times of varying satellite geometry and conditions. The amount of redundancy required is a function of the accuracy requirements of a particular survey. Redundant baseline results are especially critical in assessing the accuracy of vertical densification surveys.

b. Fixed constraint. In practice, any station on the network can be held fixed for the free adjustment. The selected point is held fixed in all three coordinates, along with the orientation of the three axes and a network scale parameter. Usually one of the higher-order points on the existing network is used.

11-14. Relative Baseline Accuracy Estimates

The accuracy of an observed GPS baseline in a network is influenced by the accuracy of the GPS observation (i.e. baseline covariance matrix) and the accuracy of all other GPS baselines and other conventional survey observations throughout the network. Most commercial software indicates the resultant accuracy of the baseline vectors. This output statistic is called "relative distance accuracies," "output vector residuals," and other terms depending on the software. These relative distance accuracy estimates between points in a network are determined by error propagation of the relative positional standard errors at each end of the line, as shown in Figure 11-4. Relative accuracy estimates may be derived for resultant distances or azimuths between the points. The relative distance accuracy estimates are those typically employed to assess the free and constrained accuracy classifications, typically expressed as a ratio, such as 1:80,000, a standard error statistic, or graphically in error ellipse dimensions. Since each point in the network will have its particular position variances, the relative distance accuracy propagated between any two points will also vary throughout the network. Relative positional and distance accuracy estimates resulting from a free (minimally constrained) adjustment of a GPS network are usually excellent in comparison to conventional surveying methods. Loop misclosure and relative distance accuracies between points will commonly exceed 1:100,000.

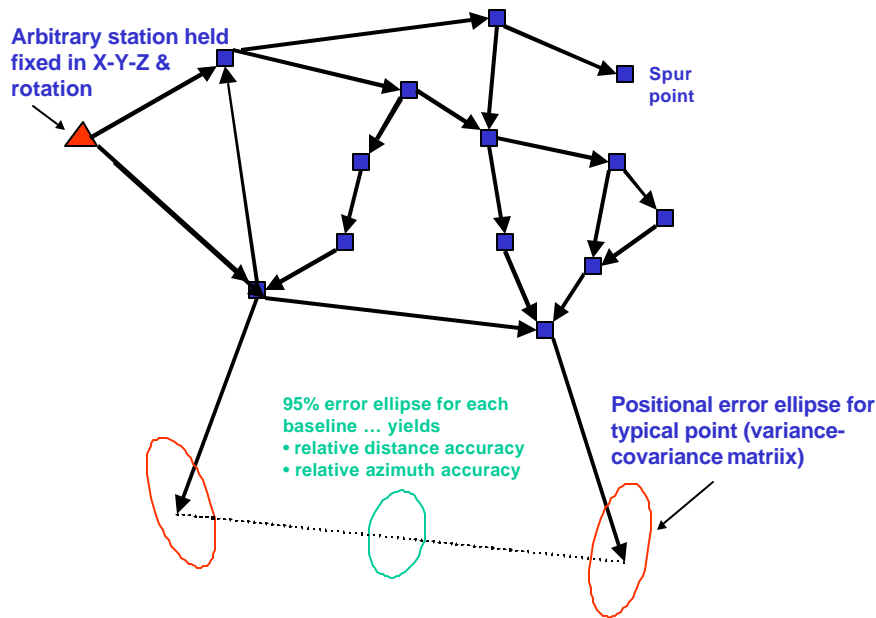

Figure 11-4. Free adjustment of a complex GPS network

a. Residual corrections. Most commercial adjustment software will output the residual corrections to each observed baseline (or actually baseline vector components). These residuals indicate the amount by which each segment was corrected in the adjustment. A least-squares adjustment minimizes the sum of the squares of these baseline residual corrections. When terrestrial survey

observations are included in the network, residual corrections may be in distance or angular units. The following output from GrafNet is typical of most software. For each observed GPS baseline session it lists the residual corrections (RE, RN, RH), a parts per million (PPM) ratio, the baseline distance in km (DIST), and the 1-sigma standard deviation (STD).

```

*****
      OUTPUT VECTOR RESIDUALS (North, East, Height - Local Level)
*****

```

SESSION NAME	-- RE -- (m)	-- RN -- (m)	-- RH -- (m)	- PPM -	DIST - (km)	STD - (m)
2 to 7 (1)	-0.0018	-0.0030	-0.0134	0.547	25.3	0.0150
3 to 7 (1)	0.0000	-0.0027	-0.0040	0.539	8.9	0.0052
6 to 7 (1)	0.0000	0.0022	0.0032	103.562	0.0	0.0047
8 to 3 (1)	0.0000	-0.0040	-0.0060	0.467	15.4	0.0064
8 to 2 (1)	-0.0024	-0.0040	-0.0176	0.572	31.8	0.0172
8 to 6 (1)	-0.0004	0.0012	0.0048	0.727	6.8	0.0061

RMS	0.0012	0.0030	0.0098			

b. Free adjustment assessment criteria. The primary criteria for assessing the adequacy of a particular GPS survey shall be based on the relative distance accuracy results from a minimally constrained free adjustment, not the fully constrained adjustment. This is due to the difficulty in assessing the adequacy of the surrounding network. Should the propagated relative accuracies fall below the specified level, then reobservation would be warranted.

(1) The minimum relative distance accuracy value (i.e. the largest ratio) will govern the relative accuracy of the overall project. This minimum value (from a free adjustment) is then compared with the intended relative accuracy classification of the project to evaluate compliance. However, relative distance accuracy estimates should not be rigidly evaluated over short lines (i.e. less than 500 m).

(2) Depending on the size and complexity of the project, large variances in the propagated relative distance accuracies can result.

c. Constrained adjustment. When a constrained adjustment is subsequently performed, the adequacy of the external fixed stations will have a major impact on the resultant propagated distance accuracies, especially when connections are made to weak control systems. Properly weighted partially constrained adjustments will usually improve the propagated distance accuracies. If the relative distance accuracies significantly degrade on a constrained adjustment (due to the inadequacy of the surrounding network), additional connections to the network may be required to resolve the conflicts. A large variance of unit weight usually results in such cases.

11-15. Normalized or Standardized Residuals

The magnitude of the residual corrections shown in the sample adjustments may be assessed by looking for blunders or outliers; however, this assessment should be performed in conjunction with the related "normalized residual" or "standardized residual" statistic--i.e. $v / \sigma = v \cdot \sqrt{w}$. Most commercial software packages provide this statistic for each observation. This statistic is obtained by multiplying the residual by the square root of the input weight (the inverse of the square of the standard error). If the observations are properly weighted, the "normalized residuals" should be around 1.0. Most adjustment software will flag normalized residuals that exceed selected statistical outlier tests. Such flagged

normalized residuals are candidates for rejection. A rule-of-thumb reject criterion should be set at three times the standard error of unit weight, again provided that the variance of unit weight is within the acceptable range given in Table 11-1 above. All rejected GPS observations must be justified in the adjustment report, which should clearly describe the test used to remove the observation from the file. The following excerpt from a GeoLab output shows the standardized residual (STD RES) in the last column. This value is computed from data in the next to last column--dividing the RESIDUAL by the STD DEV (standard error)-- v / σ .

```

=====
                                gpstrav.iob
Microsearch GeoLab, V2001.9.20.0          WGS 84          UNITS: m,DMS  Page 0006
=====
Residuals (critical value = 1.728):
NOTE: Observation values shown are reduced to mark-to-mark.
                                OBSERVATION RESIDUAL  STD RES
TYPE AT          FROM          TO          STD DEV  STD DEV  PPM
-----
DXCT             Control 1    Point 1    -4996.35800    0.013    1.938

                                0.012    0.006    1.69
=====

```

11-16. Outlier Tests and Reject Criteria

One of the main purposes of the free adjustment is to check for poor observational data. This is accomplished by reviewing the statistics from the adjustment output software. The statistics can be presented in tabular format or graphically, depending on the software. A variety of statistical tests have been developed to evaluate survey data. Most involve some type of outlier test. Most adjustment software will output standardized or normalized residuals for each observation, as defined above. This equalizes all angular and distance observations so relative assessments can be made. Standardized residuals are typically plotted on histograms that provide a graphical assessment of outlying observations--for example, those beyond a "x-sigma" standardized residual distance. The criteria for determining "x-sigma" may be obtained from the Tau Criteria, a statistic derived from a standard Student t-distribution statistic. Thus, for a large data set, "x" will typically be around "3" meaning normalized residuals greater than 3-sigma from the mean are outliers and candidates for reject. Chi-square is another statistical test used to assess the validity of the adjusted/computed variance of unit weight (reference variance), and is especially useful for small data sets, i.e. those with few degrees of freedom. The Marginally Detectable Error (MDE) is a statistic used by NGS in their ADJUST program. The MDE is a measure of how large an error has to be before the standardized residual reaches 3-sigma. The general flow sequence for using these criteria is illustrated in Figure 11-5 below. This figure details the sequential "free" adjustments that may be necessary to isolate observational blunders, using the Chi-square, Tau, and variance statistics. Use of all these statistics requires a full understanding of their underlying concepts--these concepts are well covered in vendor's user manuals and/or "help" files that accompany the software. See also the references in Appendix A.

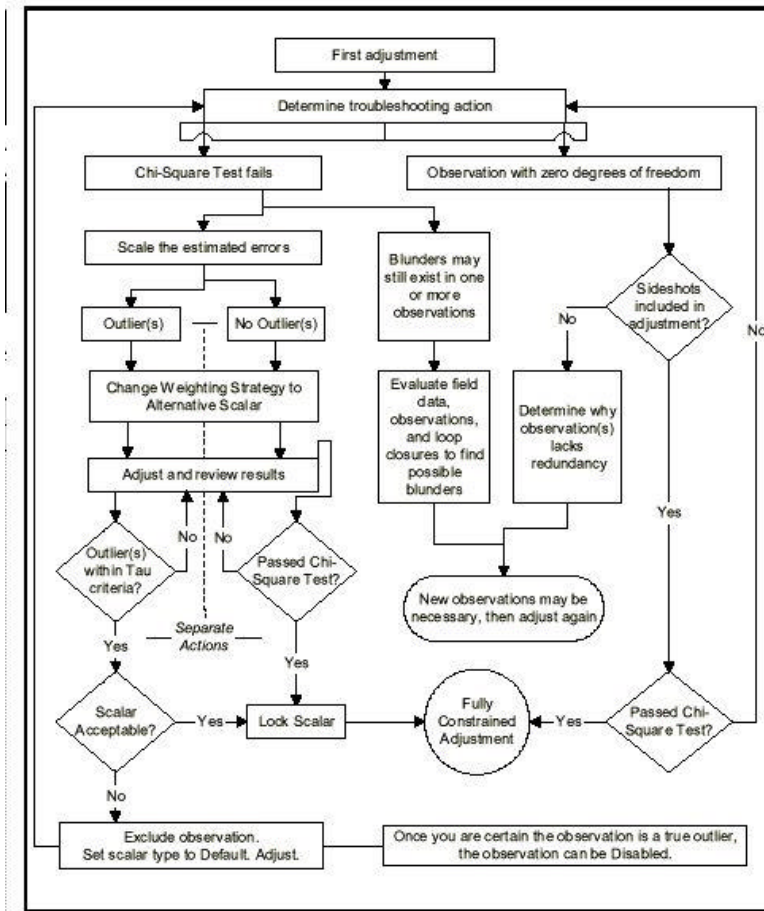

Figure 11-5. Use of outlier test statistics in performing a network adjustment (Trimble Navigation LTD)

The following is a typical statistical summary taken from a GeoLab adjustment. GeoLab uses a "Tau-max" criteria for assessing outlier observations. GeoLab also has options for other statistical outlier tests (e.g., Student t). In this sample, four residuals exceeded the Tau-max 1.7284 limit that was computed for this data set. The Chi-square test on the variance of unit weight allowed for a wide "Pass" range of 0.446 to 20.198. This is due to the relatively small number of observations and degrees of freedom ($r = 3$).

S T A T I S T I C S S U M M A R Y	
Residual Critical Value Type	Tau Max
Residual Critical Value	1.7284
Number of Flagged Residuals	4
Convergence Criterion	0.0010
Final Iteration Counter Value	2
Confidence Level Used	95.0000
Estimated Variance Factor	1.4529
Number of Degrees of Freedom	3

Chi-Square Test on the Variance Factor:

4.6625e-01 < 1.0000 < 2.0198e+01 ?

THE TEST PASSES

NOTE: All confidence regions were computed using the following factors:

Variance factor used	=	1.4529
1-D expansion factor	=	1.9600
2-D expansion factor	=	2.4477

Note that, for relative confidence regions, precisions are computed from the ratio of the major semi-axis and the spatial distance between the two stations.

11-17. Positional Accuracy Statistics and Error Ellipses

2-D error ellipses (or 3-D error ellipsoids) generated from the adjustment variance-covariance matrices for each adjusted point are also useful in depicting the relative positional accuracy--see Figure 11-6. The scale of the ellipse may be varied as a function of the 2-D deviation. In the Corps a 95 % probability ellipse is selected for output since final accuracies are always reported at the 95% confidence level--refer to accuracy reporting standards specified in FGDC 1998a and FGDC 1998b. The size of the error ellipse will give an indication of positional reliability, and the critical relative distance/azimuth accuracy estimate between two adjacent points is a direct function of the size of these positional ellipses.

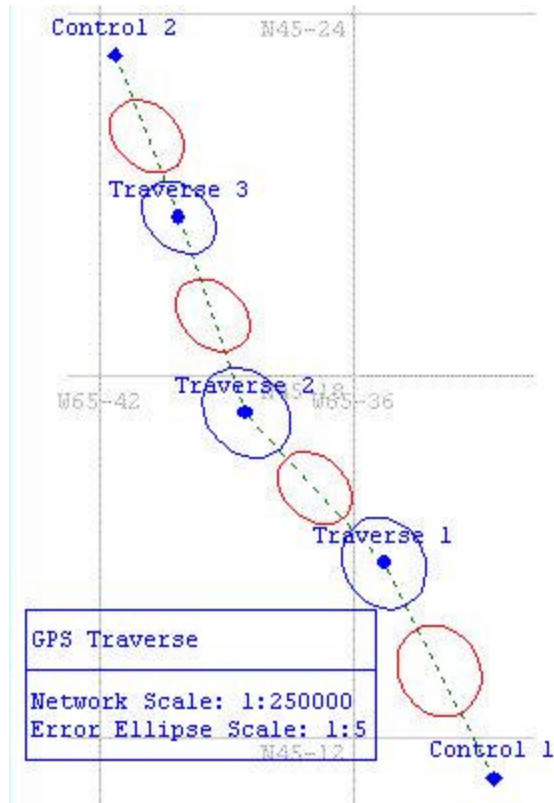

Figure 11-6. Relative accuracy ellipses for points (blue) and baselines (red). Control 1 and Control 2 are fixed points. (Microsearch GeoLab 2001 Adjustment Software)

A typical list of positional accuracies resulting from a least-squares adjustment is shown below. The standard errors are shown for the local coordinate system (E-N-UP) and the 1-sigma covariance matrix is relative to the geocentric (X-Y-Z) coordinate system. From these data the error ellipses shown above are formed.

```

*****
          OUTPUT VARIANCE/COVARIANCE
*****
                                     2
STA_ID   SE/SN/SUP  ----- CX matrix (m )-----
          (95.00 %) (not scaled by confidence level)
          (m)       (ECEF, XYZ cartesian)
2         0.0093   2.7948e-005
          0.0099   3.2261e-005  8.7560e-005
          0.0296  -2.4249e-005 -5.7075e-005  6.1238e-005
  
```

The following adjustment outputs are excerpts taken from Star*Net 6.0. It illustrates error ellipse and line accuracy output data typical of mixed terrestrial and GPS vector observations. Terrestrial observations included EDM, horizontal angles, and vertical angles (zenith distances).

Adjusted Measured Geodetic Angle Observations (DMS) Horizontal Angle Observations

At	From	To	Angle	Residual	StdErr	StdRes
0013	0012	0051	67-58-22.13	-0-00-01.37	0.52	2.6
0051	0013	0052	160-18-02.35	0-00-00.65	0.61	1.1

Adjusted Measured Distance Observations (Meters) EDM Distance Observations

From	To	Distance	Residual	StdErr	StdRes
0013	0051	4013.9490	-0.0010	0.0158	0.1
0051	0052	2208.2595	-0.0105	0.0122	0.9

Adjusted Zenith Observations (DMS) Vertical Angle Observations

From	To	Zenith	Residual	StdErr	StdRes
0013	0051	90-04-41.00	-0-00-03.00	3.00	1.0
0051	0052	90-14-28.41	-0-00-04.59	3.00	1.5

Adjusted GPS Vector Observations Sorted by Names (Meters) GPS Vector Observations

From	Component	Adj Value	Residual	StdErr	StdRes
To					
(V1 Day125(1) 14:14	00120013.SSF)				
0012	Delta-N	-10107.7168	0.0011	0.0035	0.3
0013	Delta-E	1770.6887	0.0019	0.0032	0.6
	Delta-U	-27.1137	-0.0018	0.0049	0.4
	Length	10261.6769			

Adjusted Azimuths (DMS) and Horizontal Distances (Meters) Relative accuracies and error ellipse data--for azimuths between points on network

=====
(Relative Confidence of Azimuth is in Seconds)

From	To	Grid Azimuth	Grid Dist	95% RelConfidence		
				Grnd Dist	Azi	Dist
0012	0013	170-36-18.76	10261.4179	0.12	0.0065	0.6324
			10261.6712			
0012	0016	119-21-46.52	7490.5576	0.13	0.0046	0.6123
			7490.7714			

Station Coordinate Error Ellipses (Meters) Error ellipse data for adjusted points on network
Confidence Region = 95%

Station	Semi-Major Axis	Semi-Minor Axis	Azimuth of Major Axis	Elev
0012	0.000000	0.000000	0-00	0.000000
0013	0.006490	0.006144	170-13	0.000000

Relative Error Ellipses (Meters) Relative line error ellipse data for adjusted points on network
Confidence Region = 95%

Stations	Semi-Major Axis	Semi-Minor Axis	Azimuth of Major Axis	Vertical
From To				
0012 0013	0.006490	0.006144	170-13	0.000000
0012 0016	0.004786	0.004569	13-12	0.006523

11-18. Sample GPSurvey Network Adjustment--San Juan PR Flood Control Project

The following Trimble GPSurvey adjustment example is taken from GPS control surveys performed on a flood control project near San Juan, PR. This Jacksonville District survey was conducted to extend both horizontal and vertical control from NGRS points to the flood control project area.

Sample of Trimble GPSurvey Observation Adjustment Summary

OBSERVATION ADJUSTMENT SUMMARY (Observed and Adjusted Parameters)

NETWORK = 02097base
 TIME = Wed Jul 24 17:53:49 2002
 OBSERVATION ADJUSTMENT (Tau = 3.61)
 GPS Parameter Group 1 GPS Observations
 Azimuth rotation = -0.1347 seconds
 Deflection in latitude = +2.4780 seconds
 Deflection in longitude = +4.3040 seconds
 Network scale = 1.000001515015

Network calibration parameters

1.00σ = 0.0155 seconds
 1.00σ = 1.5593 seconds
 1.00σ = 0.9980 seconds
 1.00σ = 0.00000064660

OBS#	BLK#/ REF#	TYPE	BACKSIGHT/ INSTRUMENT/ FORESIGHT	UDVC/ UDPG/ SBNT	OBSERVED/ ADJUSTED/ RESIDUAL	1.00σ/ 1.00σ/ 1.00σ	TAU Tau Test
1	***- 1	hgoid	***- A 1001 ***-	***- ***- 1	-45.2101m -45.2101m -0.000001m	0.0001m 0.0001m 0.0000m	0.49
2	***- 2	hgoid	***- COMERIO ***-	***- ***- 1	-41.3690m -41.3690m +0.000000m	0.0001m 0.0001m 0.0000m	OPEN
17	2 1	gpsaz	***- PUR 3 A 1001	***- ***- 1	90°12'28.3727" 90°12'28.3885" +0.015842"	0.0356" 0.0132" 0.0330"	0.13
18	2 1	gpsht	***- PUR 3 A 1001	***- ***- 1	-131.9826m -131.9021m +0.080439m	0.1479m 0.0349m 0.1437m	0.16
19	2 1	gpsds	***- PUR 3 A 1001	***- ***- 1	104825.8866m 104825.9576m +0.070964m	0.0594m 0.0070m 0.0590m	0.33

•
•
• **GPS Azimuth-Height-Distance residuals for each baseline (OBSERVATIONS 20 THRU 223 NOT SHOWN)**

224	71 1	gpsaz	***- PUR 3 TATI	***- ***- 1	92°41'28.2839" 92°41'28.2472" -0.036688"	0.0308" 0.0133" 0.0277"	0.37
225	71 1	gpsht	***- PUR 3 TATI	***- ***- 1	-124.3835m -124.3994m -0.015882m	0.1211m 0.0405m 0.1141m	0.04
226	71 1	gpsds	***- PUR 3 TATI	***- ***- 1	104537.6590m 104537.6797m +0.020775m	0.0155m 0.0066m 0.0141m	0.41

Sample of Trimble GPSurvey Observation Adjustment Summary (Continued)

ADJUSTMENT SUMMARY

NETWORK = 02097base TIME = Wed Jul 24 17:53:48 2002

Network Reference Factor = 1.00
Chi-Square Test ($\hat{\alpha}$ = 95%) = PASS
Degrees of Freedom = 163.00

**Degrees
of
Freedom
"r"**

GPS OBSERVATIONS
Reference Factor = 1.00 r = 163.00

GPS Solution	1	Reference Factor =	1.00	r =	0.00
GPS Solution	2	Reference Factor =	0.75	r =	2.77
GPS Solution	3	Reference Factor =	2.13	r =	1.82
GPS Solution	4	Reference Factor =	1.95	r =	2.68
•					
•					
GPS Solution	67	Reference Factor =	0.64	r =	2.46
GPS Solution	68	Reference Factor =	0.51	r =	2.61
GPS Solution	69	Reference Factor =	1.91	r =	2.59
GPS Solution	70	Reference Factor =	1.00	r =	0.00
GPS Solution	71	Reference Factor =	1.16	r =	2.51

**Reference Factors for
Baseline Solutions**

GEOID MODEL

Reference Factor = 1.57 r = 0.00

Geoid Heights:	Reference Factor =	1.57	r =	0.00
Delta Geoid Heights:	Reference Factor =	1.00	r =	0.00

**Reference Factors for
Geoid Model**

WEIGHTING STRATEGIES:

GPS OBSERVATIONS: Scalar Weighting Strategy:
Alternative Scalar Set Applied Globally = 12.88

No summation weighting strategy was used

Station Error Strategy: H.I. error = 0.0051 Tribrach error = 0.0051

**Weight Assignments for
GPS and equipment
centering**

GEOID MODEL: Scalar Weighting Strategy:
Alternative Scalar Set Applied Globally = 0.00

No summation weighting strategy was used

Results of adjusted Geoid model: Noise in vertical GPS observations: 0.01911537

Variance of geoid model: 0.00000001

Further use of correlated Geoid Model not recommended

Sample of Trimble GPSurvey Observation Adjustment Summary (Continued)

NETWORK ADJUSTMENT CONSTRAINTS

NETWORK = 02097base
TIME = Wed Jul 24 17:53:48 2002

Datum = NAD-83
Coordinate System = Geographic
Zone = Global

Network Adjustment Constraints:
3 fixed coordinates in y
3 fixed coordinates in x
3 fixed coordinates in h

**3 Constrained Points
in X-Y-Z**

**1-sigma errors in X, Y,
and height**

POINT	NAME	OLD COORDS	ADJUST	NEW COORDS	1.00σ
1	A 1001				
	LAT=	18° 27' 24.980321"	+0.000000"	18° 27' 24.980321"	0.005905m
	LON=	66° 04' 28.426893"	+0.000000"	66° 04' 28.426893"	0.005750m
	ELL HT=	-42.4781m	+0.0000m	-42.4781m	0.000120m
	ORTHO HT=	2.7320m	+0.0000m	2.7320m	FIXED
	GEOID HT=	-45.2101m	+0.0000m	-45.2101m	0.000120m
2	COMERIO				
	LAT=	18° 14' 08.759650"	+0.000000"	18° 14' 08.759650"	FIXED
	LON=	66° 12' 52.299500"	+0.000000"	66° 12' 52.299500"	FIXED
	ELL HT=	149.1713m	+0.0000m	149.1713m	0.214935m
	ORTHO HT=	190.5403m	+0.0000m	190.5403m	0.214935m
	GEOID HT=	-41.3690m	+0.0000m	-41.3690m	0.000120m
3	DRYDOCK				
	LAT=	18° 26' 47.892303"	+0.000000"	18° 26' 47.892303"	0.006453m
	LON=	66° 05' 28.523900"	+0.000000"	66° 05' 28.523900"	0.006270m
	ELL HT=	-42.8225m	+0.0000m	-42.8224m	0.039711m
	ORTHO HT=	2.1642m	+0.0000m	2.1643m	0.039712m
	GEOID HT=	-44.9867m	+0.0000m	-44.9867m	0.000120m
4	MESAS				
	LAT=	18° 16' 11.084080"	+0.000000"	18° 16' 11.084080"	FIXED
	LON=	66° 03' 12.743070"	+0.000000"	66° 03' 12.743070"	FIXED
	ELL HT=	326.5441m	+0.0001m	326.5442m	0.154736m
	ORTHO HT=	368.7046m	+0.0001m	368.7047m	0.154736m
	GEOID HT=	-42.1605m	+0.0000m	-42.1605m	0.000120m
		•			
		•			
		•			
		•			
13	TATI				
	LAT=	18° 24' 57.790078"	+0.000000"	18° 24' 57.790078"	0.006387m
	LON=	66° 04' 42.999849"	+0.000000"	66° 04' 42.999849"	0.006301m
	ELL HT=	-34.9294m	+0.0000m	-34.9294m	0.040113m
	ORTHO HT=	9.4295m	+0.0000m	9.4296m	0.040113m
	GEOID HT=	-44.3590m	+0.0000m	-44.3590m	0.000120m

Sample of Trimble GPSurvey Observation Adjustment Summary (Continued)

SUMMARY OF BASELINE COVARIANCES

NETWORK = 02097base
TIME = Wed Jul 24 17:53:49 2002

Definition of precision $(E \times S)\hat{y} = C\hat{y} + P\hat{y}$:

Horizontal:

Precision (P) expressed as: ratio
Propagated linear error (E): U.S.
(standard error of adjusted horizontal distance)
Scalar (S) on propagated linear error: 1.0000
Constant error term (C): 0.0000

3-Dimensional:

Precision (P) expressed as: ratio
Propagated linear error (E): U.S.
(standard error of adjusted slope distance)
Scalar (S) on propagated linear error: 1.0000
Constant error term (C): 0.0000
Using orthometric height errors

**Azimuth-Distance-Height
errors for each observed
baseline**

Absolute and ratio

FROM/ TO	AZIMUTH/ DELTA H	1.00σ 1.00σ	DISTANCE/ DELTA h	1.00σ 1.00σ	HOR PREC/ 3-D PREC
A 1001 COMERIO	211°10'02" +191.6495m	0.04" 0.2149m	28603.164m +187.8083m	0.0059m 0.2149m	1: 4837618 1: 4837618
A 1001 DRYDOCK	237°06'49" -0.3443m	0.64" 0.0397m	2099.955m -0.5677m	0.0068m 0.0397m	1: 309088 1: 309088
A 1001 MESAS	173°52'33" +369.0223m	0.06" 0.1547m	20838.212m +365.9727m	0.0059m 0.1547m	1: 3536897 1: 3536897
A 1001 MP 1	203°05'54" +6.2453m	0.51" 0.0254m	2160.316m +5.8614m	0.0056m 0.0254m	1: 382773 1: 382773
	•				
	•				
	•				
	•				
RRS 1 TATI	212°00'38" -8.7112m	0.33" 0.0592m	4586.198m -9.4431m	0.0075m 0.0592m	1: 615545 1: 615545
SJH 44 SJHL 11 RM 1	163°44'08" +1.4034m	0.37" 0.0363m	3556.270m +0.7455m	0.0063m 0.0363m	1: 566242 1: 566242
SJH 44 TATI	139°55'03" +8.9809m	0.18" 0.0401m	6204.046m +8.0800m	0.0051m 0.0401m	1: 1210786 1: 1210786
SJHL 11 RM 1 TATI	113°58'02" +7.5775m	0.49" 0.0387m	3281.605m +7.3344m	0.0074m 0.0387m	1: 444627 1: 444627

Sample of Trimble GPSurvey Observation Adjustment Summary (Continued)

FINAL ADJUSTED COORDINATES AND HEIGHTS

Projection Group: Geographic
 Zone Name: Puerto Rico
 Linear Units: meter
 Angular Units: degrees
 Datum Name: NAD-83

Ortho Hgt = Ellip Hgt + Geoid Undulation (N)

Station	Latitude Northing (Y)	Longitude Easting (X)	Ortho.Hgt(m) Ortho. Hgt(ft)	Ellip. Hgt
A 1001	18°27'24.98033" N 882738.00637	066°04'28.42689" W 780498.87896	2.73200 8.96324	-42.48337
COMERIO	18°14'08.75965" N 802345.96891	066°12'52.29950" W 732089.99908	190.56082 625.22327	149.19186
DRYDOCK	18°26'47.89232" N 878985.77825	066°05'28.52390" W 774720.68565	2.16132 7.08975	-42.82538
MESAS	18°16'11.08408" N 814776.08472	066°03'12.74307" W 787925.49457	368.70346 1209.66679	326.54298
MP 1	18°26'20.34912" N 876213.11755	066°04'57.30844" W 777731.11182	8.59188 28.18954	-36.23434
MP 3	18°26'18.28984" N 876013.28555	066°04'15.21238" W 781784.27695	6.58580 21.60691	-38.22604
PN 007	18°24'00.86849" N 862161.61528	066°03'22.35068" W 786902.04404	13.16149 43.18265	-30.89685
PN 030	18°23'50.41792" N 861089.02683	066°04'58.66515" W 777629.43315	11.87409 38.96153	-32.12466
PUR 3	18°27'46.70249" N 885187.27032	067°04'01.05083" W 436591.08273	133.53638 438.16948	87.35157
RRS 1	18°27'04.27895" N 880663.02269	066°03'20.16586" W 787074.26883	18.86853 61.90391	-26.22228
SJH 44	18°27'32.19208" N 883438.71281	066°06'59.11446" W 765991.82221	1.34960 4.42781	-43.90927
SJHL11RM	18°25'41.15411" N 872243.79347	066°06'25.17479" W 769278.91615	2.09702 6.88033	-42.50505
TATI	18°24'57.79009" N 867887.87460	066°04'42.99983" W 779124.78992	9.42896 30.93844	-34.92999

***** End of Report *****

11-19. Sample Network Adjustment--Virginia Key, FL Disposal Area Site

The following adjustment is an example of a small network adjustment using Waypoint Consulting's GrafNet software. The project is located at Virginia Key, Dade County, Florida. The GPS survey was performed for the Jacksonville District by Sea Systems, Inc. The purpose of the survey was to provide reference horizontal and vertical control for a topographic survey of the Northern Virginia Key Disposal Site, for ultimate use in determining fill capacity for possible use in upcoming construction dredging in Miami Harbor. The reference control will be used to obtain cross-sections at 100-foot intervals across the disposal site. A sketch of the network is shown in Figure 11-7 below.

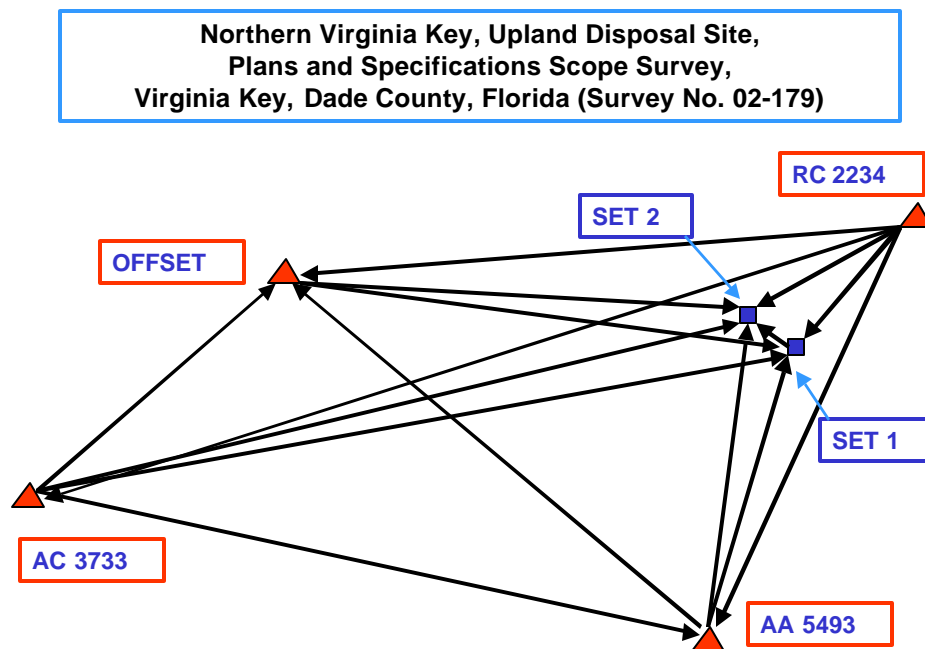

Figure 11-7. Virginia Key Disposal Site Control Network

In the above figure, stations shown in triangles are known points. These known points have either fixed horizontal coordinates or fixed elevations; or both--see INPUT CONTROL block on the following constrained adjustment. Fixed coordinates were given a standard error of ± 5 mm. Point OFFSET is a benchmark with no fixed position. Its elevation was also assigned a standard error of ± 5 mm. The two points to be adjusted are "SET 1" and SET 2." Baseline observations between the points are as indicated. A total of 35 baselines were observed and adjusted, including redundant lines. Baselines were reduced and a free (unconstrained) adjustment was run with no outlier rejects. The following GrafNet constrained adjustment is held to NAVD 88 orthometric elevations at the fixed points. This same network was also adjusted to obtain NGVD 29 elevations but these results are not shown in this example. However, a summary of the NGVD 29 and NAVD 88 adjusted elevations is shown at the end of the adjustment.

Virginia Key, FL Constrained Network Adjustment

```
*****
* NETWORK - WEIGHTED GPS NETWORK ADJUSTMENT *
*
* (c) Copyright Waypoint Consulting Inc., (2000) *
*
* VERSION: 6.03 *
*
* FILE: C:\02179A\02179A.net
*****
```

DATE(m/d/y): Thur. 10/03/02 TIME: 13:27:09

```
DATUM:          'NAD83'
GRID:           Grid: US State Plane, FL East
SCALE_FACTOR:   57.6315
CONFIDENCE LEVEL: 95.00 % (Scale factor is 2.4479)
```

Fixed X-Y-Z Points:
AA5493
AC2234
AC3733
Fixed in Z only: OFFSET

```
*****
INPUT CONTROL/CHECK POINTS
*****
```

STA_ID	TYPE	-- LATITUDE --	-- LONGITUDE --	ELLHGT -	HZ-SD	V-SD
AA5493	GCP-3D	25 43 35.37003	-80 09 15.51953	-24.944	0.00500	0.00500
AC2234	GCP-3D	25 45 56.06211	-80 08 02.49717	-23.521	0.00500	0.00500
AC3733	GCP-3D	25 44 26.83627	-80 13 10.56329	-24.315	0.00500	0.00500
OFFSET	GCP-VT			-20.733		0.00500

5 mm standard errors

```
*****
INPUT VECTORS
*****
```

35 observed baseline input vectors & covariance matrices

SESSION NAME	VECTOR(m)	----- Covariance (m) [unscaled] -----
	DX/DY/DZ	standard deviations in brackets
AA5493 to OFFSET (1)	-4345.9720 911.4010 3410.0230	8.1161e-007 (0.0009) -1.5108e-007 1.5096e-006 (0.0012) 7.4691e-007 -1.1100e-006 3.1877e-006 (0.0018)
AA5493 to OFFSET (2)	-4345.9790 911.3820 3410.0200	9.4716e-007 (0.0010) -1.3388e-006 6.5898e-006 (0.0026) 6.3886e-007 -2.1769e-006 1.6410e-006 (0.0013)
AA5493 to OFFSET (3)	-4345.9750 911.3960 3410.0190	8.8808e-007 (0.0009) -7.9258e-007 3.2975e-006 (0.0018) 4.7680e-008 -3.0244e-007 8.9945e-007 (0.0009)
AA5493 to SET1 (1)	527.3470 1463.4770 2804.1390	2.5454e-007 (0.0005) -1.3575e-007 1.5997e-006 (0.0013) 1.5573e-008 -6.5468e-007 6.0109e-007 (0.0008)
AA5493 to SET1 (2)	527.3460 1463.4670 2804.1500	9.6956e-007 (0.0010) -1.0256e-006 4.0156e-006 (0.0020) 5.8803e-007 -1.8213e-006 1.1555e-006 (0.0011)
AA5493 to SET1 (3)	527.3410 1463.4740 2804.1560	6.7566e-007 (0.0008) -8.9273e-007 2.8178e-006 (0.0017) 3.4075e-007 -9.6947e-007 8.4725e-007 (0.0009)

Virginia Key, FL Constrained Network Adjustment (Continued)

AA5493 to SET2 (1)	183.4260	2.7612e-007	(0.0005)				
	1518.1400	-1.2588e-007	1.6500e-006	(0.0013)			
	3037.5440	2.3001e-009	-6.8352e-007	6.7586e-007	(0.0008)		
AA5493 to SET2 (2)	183.4290	6.8405e-007	(0.0008)				
	1518.1260	-5.4212e-007	4.3782e-006	(0.0021)			
	3037.5590	1.6255e-007	-6.6215e-007	7.2271e-007	(0.0009)		
AA5493 to SET2 (3)	183.4240	6.8019e-007	(0.0008)				
	1518.1320	-4.8324e-007	3.7894e-006	(0.0019)			
	3037.5660	1.7634e-007	-4.6283e-007	7.3229e-007	(0.0009)		
AC2234 to AA5493 (1)	-1683.4200	8.7470e-007	(0.0009)				
	-2200.0290	-1.4696e-007	1.9535e-006	(0.0014)			
	-3900.3850	-3.9538e-007	-4.1776e-007	2.1921e-006	(0.0015)		
AC2234 to AA5493 (2)	-1683.4430	1.2038e-006	(0.0011)				
	-2200.0120	-9.9266e-007	4.5283e-006	(0.0021)			
	-3900.4030	7.4956e-007	-1.9036e-006	1.3560e-006	(0.0012)		
AC2234 to OFFSET (1)	-6029.4190	1.5439e-004	(0.0124)				
	-1288.7690	1.7075e-005	3.0166e-004	(0.0174)			
	-490.3520	2.6812e-005	-4.7363e-005	3.3521e-005	(0.0058)		
AC2234 to OFFSET (2)	-6029.4140	9.4516e-007	(0.0010)				
	-1288.5960	-8.3686e-007	1.2101e-005	(0.0035)			
	-490.3920	4.5221e-007	-4.1408e-006	2.4716e-006	(0.0016)		
AC2234 to SET1 (1)	-1156.0830	7.1801e-007	(0.0008)				
	-736.5510	-1.2067e-007	1.6032e-006	(0.0013)			
	-1096.2420	-3.2557e-007	-3.3912e-007	1.7975e-006	(0.0013)		
AC2234 to SET1 (2)	-1156.0990	6.3275e-007	(0.0008)				
	-736.5380	-5.6626e-007	5.9402e-006	(0.0024)			
	-1096.2560	1.4765e-007	-7.1220e-007	6.5753e-007	(0.0008)		
AC2234 to SET2 (1)	-1500.0060	7.2331e-007	(0.0009)				
	-681.8870	-1.2156e-007	1.6151e-006	(0.0013)			
	-862.8380	-3.2796e-007	-3.4163e-007	1.8107e-006	(0.0013)		
AC2234 to SET2 (2)	-1500.0190	6.3474e-007	(0.0008)				
	-681.8700	-5.6714e-007	5.9473e-006	(0.0024)			
	-862.8530	1.4802e-007	-7.1328e-007	6.5867e-007	(0.0008)		
AC3733 to AA5493 (1)	6572.5550	1.2659e-006	(0.0011)				
	439.5040	-1.3419e-006	5.2399e-006	(0.0023)			
	-1426.9770	7.8483e-007	-2.4146e-006	1.5525e-006	(0.0012)		
AC3733 to AA5493 (2)	6572.5490	7.1515e-007	(0.0008)				
	439.5320	-5.4746e-007	4.5827e-006	(0.0021)			
	-1427.0080	1.6796e-007	-5.0904e-007	6.6952e-007	(0.0008)		
AC3733 to AC2234 (1)	8255.9920	1.0793e-006	(0.0010)				
	2639.5390	-1.2860e-006	1.3182e-005	(0.0036)			
	2473.3960	6.4343e-007	-5.0607e-006	3.2850e-006	(0.0018)		

Virginia Key, FL Constrained Network Adjustment (Continued)

AC3733 to OFFSET (1)	2226.5690	6.3259e-007 (0.0008)
	1350.9290	-8.5721e-007 2.8679e-006 (0.0017)
	1983.0120	3.1585e-007 -9.3196e-007 7.7437e-007 (0.0009)
AC3733 to OFFSET (2)	2226.5840	8.1728e-007 (0.0009)
	1350.9190	-1.1227e-006 4.4849e-006 (0.0021)
	1983.0190	5.1104e-007 -1.1740e-006 9.7556e-007 (0.0010)
AC3733 to SET1 (1)	7099.8930	7.8833e-007 (0.0009)
	1902.9860	-5.8486e-007 4.7634e-006 (0.0022)
	1377.1540	1.9193e-007 -5.4995e-007 7.7778e-007 (0.0009)
AC3733 to SET1 (2)	7099.8960	8.5710e-007 (0.0009)
	1903.0120	-1.2296e-006 5.1840e-006 (0.0023)
	1377.1400	4.6990e-007 -1.1777e-006 9.5439e-007 (0.0010)
AC3733 to SET2 (1)	6755.9730	8.3658e-007 (0.0009)
	1957.6580	-5.8188e-007 4.3591e-006 (0.0021)
	1610.5530	2.2816e-007 -5.9007e-007 9.0215e-007 (0.0009)
AC3733 to SET2 (2)	6755.9730	1.2266e-006 (0.0011)
	1957.6830	-1.7619e-006 6.4245e-006 (0.0025)
	1610.5420	7.7503e-007 -1.6224e-006 1.2553e-006 (0.0011)
OFFSET to SET1 (1)	4873.3100	3.3145e-007 (0.0006)
	552.0730	-1.1994e-007 1.8526e-006 (0.0014)
	-605.8730	-2.0091e-008 -7.7142e-007 8.5374e-007 (0.0009)
OFFSET to SET1 (2)	4873.3150	6.4153e-007 (0.0008)
	552.0630	-5.0275e-007 1.6390e-006 (0.0013)
	-605.8550	1.9615e-007 -3.2252e-007 6.3350e-007 (0.0008)
OFFSET to SET1 (3)	4873.3180	8.7943e-007 (0.0009)
	552.0600	-1.2151e-006 4.7929e-006 (0.0022)
	-605.8460	5.5000e-007 -1.2606e-006 1.0262e-006 (0.0010)
OFFSET to SET2 (1)	4529.3890	3.2547e-007 (0.0006)
	606.7360	-1.1703e-007 1.8219e-006 (0.0013)
	-372.4680	-2.0457e-008 -7.5827e-007 8.3920e-007 (0.0009)
OFFSET to SET2 (2)	4529.3950	6.9596e-007 (0.0008)
	606.7290	-5.1822e-007 1.6025e-006 (0.0013)
	-372.4520	2.2261e-007 -3.7470e-007 7.4870e-007 (0.0009)
OFFSET to SET2 (3)	4529.3970	1.0660e-006 (0.0010)
	606.7290	-1.5254e-006 5.6727e-006 (0.0024)
	-372.4420	6.6847e-007 -1.4856e-006 1.1226e-006 (0.0011)
SET1 to SET2 (1)	-343.9200	5.5512e-007 (0.0007)
	54.6670	-4.3883e-007 3.5448e-006 (0.0019)
	233.4040	1.3188e-007 -5.3718e-007 5.8763e-007 (0.0008)
SET1 to SET2 (2)	-343.9210	5.2863e-007 (0.0007)
	54.6660	-3.9745e-007 1.2402e-006 (0.0011)
	233.4040	1.6649e-007 -2.7847e-007 5.6816e-007 (0.0008)
SET1 to SET2 (3)	-343.9210	2.3912e-007 (0.0005)
	54.6600	-1.1279e-007 1.4035e-006 (0.0012)
	233.4060	3.3420e-009 -5.8588e-007 5.8424e-007 (0.0008)

Virginia Key, FL Constrained Network Adjustment (Continued)

OUTPUT VECTOR RESIDUALS (East, North, Height - Local Level)

35 baseline residuals

SESSION NAME	-- RE -- (m)	-- RN -- (m)	-- RH -- (m)	- PPM -	DIST - (km)	STD - (m)
AA5493 to OFFSET (1)	-0.0013	-0.0110	-0.0074	2.380	5.6	0.0178
AA5493 to OFFSET (2)	0.0089	-0.0007	-0.0219	4.218	5.6	0.0230
AA5493 to OFFSET (3)	0.0025	-0.0055	-0.0096	2.031	5.6	0.0171
AA5493 to SET1 (1)	-0.0066	0.0055	0.0079	3.645	3.2	0.0119
AA5493 to SET1 (2)	-0.0039	-0.0002	-0.0056	2.137	3.2	0.0188
AA5493 to SET1 (3)	-0.0002	-0.0090	-0.0012	2.830	3.2	0.0158
AA5493 to SET2 (1)	-0.0060	0.0052	0.0071	3.136	3.4	0.0122
AA5493 to SET2 (2)	-0.0065	-0.0021	-0.0123	4.134	3.4	0.0183
AA5493 to SET2 (3)	-0.0026	-0.0113	-0.0092	4.365	3.4	0.0173
AC2234 to AA5493 (1)	-0.0074	-0.0026	-0.0119	2.981	4.8	0.0170
AC2234 to AA5493 (2)	0.0123	0.0046	0.0145	4.103	4.8	0.0202
<u>AC2234 to OFFSET (1)</u>	<u>0.0420</u>	<u>0.0358</u>	<u>-0.1446</u>	<u>25.023</u>	<u>6.2</u>	<u>0.1680</u>
AC2234 to OFFSET (2)	0.0075	-0.0019	0.0255	4.315	6.2	0.0299
AC2234 to SET1 (1)	-0.0044	-0.0019	-0.0033	3.307	1.8	0.0154
AC2234 to SET1 (2)	0.0092	0.0040	0.0168	11.121	1.8	0.0204
AC2234 to SET2 (1)	-0.0019	-0.0019	-0.0024	1.945	1.9	0.0155
AC2234 to SET2 (2)	0.0080	0.0034	0.0212	12.298	1.9	0.0204
AC3733 to AA5493 (1)	0.0020	-0.0087	-0.0281	4.382	6.7	0.0216
AC3733 to AA5493 (2)	0.0031	0.0068	0.0111	1.981	6.7	0.0185
AC3733 to AC2234 (1)	-0.0084	0.0034	-0.0083	1.364	9.0	0.0318
AC3733 to OFFSET (1)	0.0104	-0.0004	0.0027	3.283	3.3	0.0157
AC3733 to OFFSET (2)	-0.0027	-0.0014	-0.0115	3.639	3.3	0.0190
AC3733 to SET1 (1)	0.0033	0.0011	-0.0109	1.537	7.5	0.0191
AC3733 to SET1 (2)	-0.0041	0.0028	0.0178	2.465	7.5	0.0201
AC3733 to SET2 (1)	0.0015	0.0025	-0.0013	0.437	7.2	0.0187
AC3733 to SET2 (2)	-0.0028	0.0017	0.0257	3.590	7.2	0.0227
OFFSET to SET1 (1)	0.0040	0.0072	0.0092	2.505	4.9	0.0132
OFFSET to SET1 (2)	0.0008	-0.0044	-0.0082	1.891	4.9	0.0130
OFFSET to SET1 (3)	-0.0017	-0.0109	-0.0153	3.816	4.9	0.0196
OFFSET to SET2 (1)	0.0047	0.0069	0.0085	2.594	4.6	0.0131
OFFSET to SET2 (2)	-0.0001	-0.0040	-0.0056	1.510	4.6	0.0133
OFFSET to SET2 (3)	-0.0020	-0.0129	-0.0103	3.624	4.6	0.0213
SET1 to SET2 (1)	-0.0010	-0.0010	0.0031	8.072	0.4	0.0164
SET1 to SET2 (2)	0.0002	-0.0007	0.0023	5.797	0.4	0.0116
SET1 to SET2 (3)	0.0012	0.0001	-0.0039	9.631	0.4	0.0113

RMS	0.0088	0.0082	0.0275			

\$ - This session is flagged as a 3-sigma outlier

Underlined session AC2234-OFFSET (1) has abnormally large adjustment and deviation ... marginal/suspect

Virginia Key, FL Constrained Network Adjustment (Continued)

CONTROL POINT RESIDUALS (ADJUSTMENT MADE)

STA. NAME	-- RE -- (m)	-- RN -- (m)	-- RH -- (m)
AA5493	-0.0194	-0.0126	-0.0071
AC2234	0.0161	0.0085	0.0048
AC3733	0.0032	0.0041	0.0025
OFFSET			-0.0002

RMS	0.0147	0.0091	0.0044

Note that fixed control points were assigned 5 mm standard error. OFFSET was only held fixed in vertical.

OUTPUT STATION COORDINATES (LAT/LONG/HT)

STA_ID	-- LATITUDE --	-- LONGITUDE --	- ELLHGT -	ORTHOHGT
AA5493	25 43 35.36962	-80 09 15.52023	-24.9511	0.7156
AC2234	25 45 56.06239	-80 08 02.49659	-23.5162	2.1831
AC3733	25 44 26.83640	-80 13 10.56317	-24.3125	1.0849
OFFSET	25 45 38.32461	-80 11 43.58762	-20.7332	4.7284
SET1	25 45 16.52663	-80 08 47.89629	-24.6836	0.9756
SET2	25 45 24.94919	-80 08 59.71990	-24.7666	0.8763

NAVD 88 ortho heights

OUTPUT STATION COORDINATES (ECEF)

STA_ID	---- X ---- (m)	---- Y ---- (m)	---- Z ---- (m)
AA5493	983140.1505	-5664838.2823	2751785.2653
AC2234	984823.5795	-5662638.2615	2755685.6579
AC3733	976567.5973	-5665277.8079	2753212.2624
OFFSET	978794.1770	-5663926.8797	2755195.2752
SET1	983667.4918	-5663374.8111	2754589.4127
SET2	983323.5714	-5663320.1475	2754822.8171

ECEF geocentric coordinates

Virginia Key, FL Constrained Network Adjustment (Continued)

OUTPUT VARIANCE/COVARIANCE

STA_ID	SE/SN/SUP (95.00 %)	CX matrix (m ²) (not scaled by confidence level) (m) (ECEF, XYZ cartesian)			
AA5493	0.0077	9.9663e-006			
	0.0077	-4.0723e-007	1.2020e-005		
	0.0086	2.4550e-007	-6.6579e-007	1.0018e-005	
AC2234	0.0080	1.0688e-005			
	0.0081	-4.6222e-007	1.4580e-005		
	0.0094	2.5833e-007	-1.1509e-006	1.1165e-005	
AC3733	0.0079	1.0634e-005			
	0.0079	-1.0831e-006	1.5026e-005		
	0.0096	5.6622e-007	-1.2673e-006	1.0700e-005	
OFFSET	0.0082	1.1484e-005			
	0.0085	-5.7821e-007	1.3011e-005		
	0.0087	3.3286e-007	2.4449e-007	1.1682e-005	
SET1	0.0080	1.1088e-005			
	0.0082	-1.5090e-006	1.7694e-005		
	0.0105	5.1383e-007	-1.9026e-006	1.1568e-005	
SET2	0.0081	1.1180e-005			
	0.0084	-1.4287e-006	1.8188e-005		
	0.0105	4.4044e-007	-1.6083e-006	1.1714e-005	

95% adjusted position standard errors & covariance matrices for 4 fixed points and 2 new points

Used to develop relative line accuracies and error ellipses

VARIANCE FACTOR = 1.0609

Note: Values < 1.0 indicate statistics are pessimistic, while values > 1.0 indicate optimistic statistics. Entering this value as the network adjustment scale factor will bring variance factor to one.

Variance Factor close to 1.0 ... good

Project: 02179A Virginia Key Survey 2002-179
Program: GrafNet Version 6.03b
Source: Network Adjustment
CoordType: U.S. State Plane for FL East (901)
Units(h,v): U.S. Survey Feet, U.S. Survey Feet
Geoid: Geoid99-ContUS.wpg
Datum: NAD83(90)/NAVD88/NGVD29

Summary of Adjustment Results NAD 83 (90) & NAVD 88 and NGVD 29 adjustments

NAME	EASTING(X)	NORTHING(Y)	HEIGHT(88)	HEIGHT(29)
AA5493(BRUCE 2)	934579.734	507176.193	2.348	3.880
AC2234(BASE USE)	941164.684	521424.341	7.162	8.709
AC3733(LIZ)	913053.811	512239.973	3.559	5.106
OFFSET(from AC2164)	920962.902	519505.389	15.513	17.058
SET1(MH 61)	937039.950	517405.598	3.201	4.743
SET2(MH 62)	935953.420	518248.986	2.875	4.417

NOTES: AC2164 OFFSET is a temporary bench mark and is reported here for informational purposes only.

11-20. Sample Network Adjustment--Everglades National Park Modified Water Deliveries

The following project example is typical of a small network where accurate vertical control is densified using GPS methods. Given the small and critical elevation gradients in an area such as the Everglades, redundant GPS observations and good geoid model adjustments are essential. The adjustment technique is similar to that performed in the above paragraph. However, in this example, a variety of existing control is constrained in the adjustment. In the network sketch in Figure 11-8 below, only AC4421 is held fixed in X-Y-Z. AC4743 and C546 are held fixed only in elevation, and AC4450 is held in X-Y coordinates only. AC0511 is set as a "check point" in the adjustment. Since the final adjusted values did not agree with published values, its check point setting proved correct. The only point without existing coordinate values is OSC 1. A ± 5 mm standard deviation was set for all constrained coordinates. 30 baselines were observed over all possible 15 lines. Resultant elevation accuracy from this adjustment scheme was about ± 1 centimeter (95%)--excellent results.

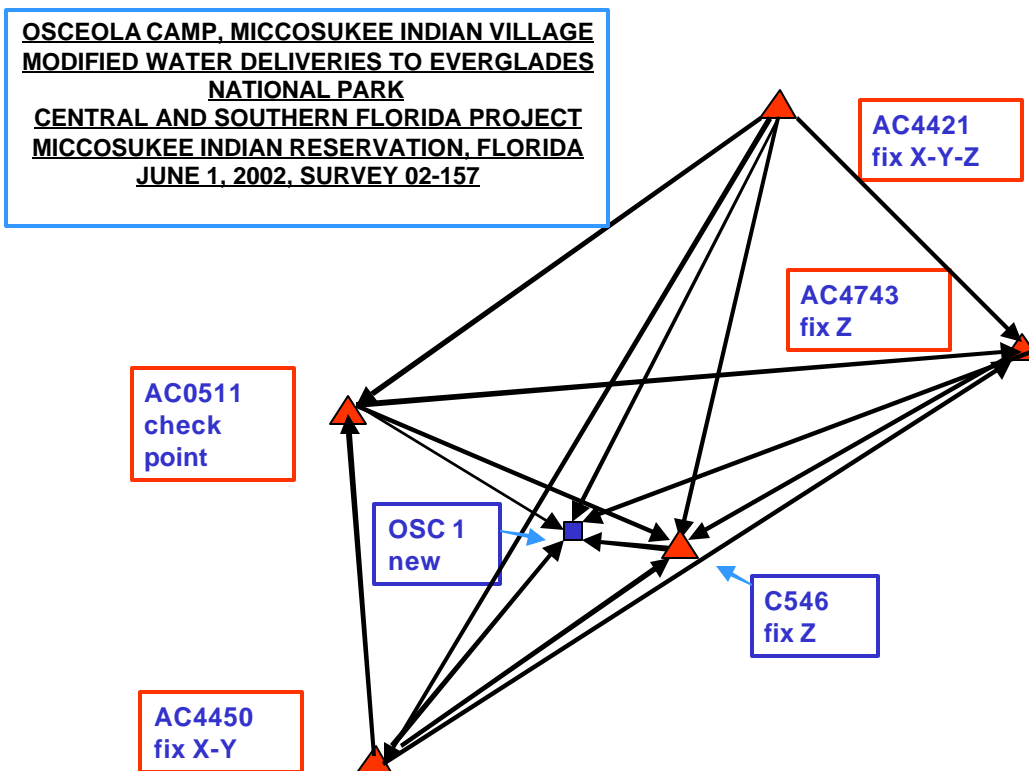

Figure 11-8. Osceola Camp GPS network control scheme

Horizontal coordinates were adjusted relative to NAD 83 (1990). The constrained elevation adjustment used the GEOID 99 model and elevations were adjusted relative to the NAVD 88 datum. A separate adjustment (not shown) was made to determine elevations relative to NGVD 29. Adjusted elevations in both NAVD 88 and NGVD 29 are listed at the end of the following adjustment output. The field survey was performed by Sea Systems, Inc. and adjusted by the Jacksonville District.

Everglades National Park--Osceola Camp GPS Adjustment

```
*****
* NETWORK - WEIGHTED GPS NETWORK ADJUSTMENT *
* *
* (c) Copyright Waypoint Consulting Inc., (2000) *
* *
* VERSION: 6.03 *
* *
* FILE: C:\02157A\01257A.net *
*****
```

DATE(m/d/y): Wed. 8/07/02 TIME: 14:56:44

```
*****
DATUM: 'NAD83'
GRID: Grid: US State Plane, FL East (901)
SCALE_FACTOR: 32.5131
CONFIDENCE LEVEL: 95.00 % (Scale factor is 2.4479)
*****
```

Fixed X-Y-Z Points:
AC4421
Fixed X-Y Points:
AC4450
Fixed Z Points:
AC4743
C546
Check Point: AC0511
New Point: OSC 1

INPUT CONTROL/CHECK POINTS

STA_ID	TYPE	-- LATITUDE --	-- LONGITUDE --	ELLHGT -	HZ-SD	V-SD
AC0511	CHK-3D	25 45 43.46685	-80 41 35.17195	-20.816		
AC4421	GCP-3D	25 51 44.92959	-80 37 19.81874	-19.325	0.00500	0.00500
AC4450	GCP-HZ	25 42 11.38117	-80 40 18.10062		0.00500	
AC4743	GCP-VT			-22.007		0.00500
C546	GCP-VT			-21.843		0.00500

INPUT VECTORS

30 observed baseline input vectors & covariance matrices

SESSION NAME	VECTOR(m) DX/DY/DZ	Covariance (m) [unscaled] standard deviations in brackets
AC0511 to AC4450 (1)	2578.6070 -2448.8320 -5879.2220	2.0675e-007 (0.0005) -9.9567e-008 1.1169e-006 (0.0011) 5.8886e-008 -3.8150e-007 4.5670e-007 (0.0007)
AC0511 to AC4450 (2)	2578.5950 -2448.8200 -5879.2160	5.7093e-007 (0.0008) -2.3657e-007 2.1838e-006 (0.0015) -3.1864e-009 -8.7442e-007 1.1279e-006 (0.0011)
AC0511 to AC4743 (1)	11409.6470 1856.3890 -54.2970	3.1346e-007 (0.0006) -1.6648e-007 1.6595e-006 (0.0013) 9.6551e-008 -5.5090e-007 6.5289e-007 (0.0008)
AC0511 to AC4743 (2)	11409.6400 1856.4020 -54.2970	6.5983e-007 (0.0008) -2.7220e-007 2.5029e-006 (0.0016) -4.5299e-009 -1.0087e-006 1.3303e-006 (0.0012)
AC0511 to C546 (1)	6402.6260 1029.4410 -50.5110	3.1519e-007 (0.0006) -1.8154e-007 1.6328e-006 (0.0013) 1.0456e-007 -5.2772e-007 6.3081e-007 (0.0008)

Everglades National Park--Osceola Camp GPS Adjustment (Continued)

AC0511 to C546 (2)	6402.6260	5.3039e-007	(0.0007)
	1029.4530	-2.1387e-007	2.0364e-006 (0.0014)
	-50.5120	-7.1812e-009	-8.1844e-007 1.0774e-006 (0.0010)
AC0511 to OSCI (1)	2826.3730	3.7274e-007	(0.0006)
	404.6930	-2.6391e-007	2.0154e-006 (0.0014)
	-124.1030	1.3580e-007	-6.6592e-007 6.5855e-007 (0.0008)
AC0511 to OSCI (2)	2826.3650	8.4775e-007	(0.0009)
	404.6950	-2.8715e-007	1.4421e-006 (0.0012)
	-124.1140	4.2744e-007	-9.1936e-007 3.2470e-006 (0.0018)
AC4421 to AC0511 (1)	-6232.2220	9.2131e-007	(0.0010)
	-5932.4830	5.4026e-007	1.2058e-005 (0.0035)
	-10014.2210	-2.7845e-007	-3.4691e-006 1.9579e-006 (0.0014)
AC4421 to AC0511 (2)	-6232.2330	7.5210e-007	(0.0009)
	-5932.4600	-3.8308e-007	2.9070e-006 (0.0017)
	-10014.2290	2.0782e-007	-1.6442e-006 3.1353e-006 (0.0018)
AC4421 to AC4450 (1)	-3653.6150	1.1259e-006	(0.0011)
	-8381.3130	-5.9188e-007	9.2928e-006 (0.0030)
	-15893.4400	2.7188e-007	-3.3162e-006 2.2906e-006 (0.0015)
AC4421 to AC4450 (2)	-3653.6400	1.0867e-006	(0.0010)
	-8381.2780	-5.7658e-007	3.6854e-006 (0.0019)
	-15893.4530	4.6676e-007	-1.9728e-006 3.1363e-006 (0.0018)
AC4421 to AC4743 (1)	5177.4260	8.6219e-007	(0.0009)
	-4076.0780	-7.9451e-007	5.2706e-006 (0.0023)
	-10068.5230	3.3408e-007	-1.8431e-006 1.4359e-006 (0.0012)
AC4421 to AC4743 (2)	5177.4070	7.8702e-007	(0.0009)
	-4076.0560	-4.5627e-007	2.7180e-006 (0.0016)
	-10068.5270	6.1596e-008	-1.0694e-006 1.2751e-006 (0.0011)
AC4421 to C546 (1)	170.4060	9.4167e-007	(0.0010)
	-4903.0240	-6.7498e-008	9.8157e-006 (0.0031)
	-10064.7380	1.1574e-007	-3.1915e-006 1.8121e-006 (0.0013)
AC4421 to C546 (2)	170.3920	5.5963e-007	(0.0007)
	-4903.0050	-2.5663e-007	2.3604e-006 (0.0015)
	-10064.7420	2.1925e-008	-9.4061e-007 1.0812e-006 (0.0010)
AC4421 to OSCI (1)	-3405.8410	8.5957e-007	(0.0009)
	-5527.7820	4.5942e-007	1.1213e-005 (0.0033)
	-10138.3240	-2.5094e-007	-3.2530e-006 1.8422e-006 (0.0014)
AC4421 to OSCI (2)	-3405.8610	8.3149e-007	(0.0009)
	-5527.7630	-4.1256e-007	4.0949e-006 (0.0020)
	-10138.3360	8.6963e-008	-1.5747e-006 1.4468e-006 (0.0012)
AC4450 to AC4743 (1)	8831.0450	6.3641e-007	(0.0008)
	4305.2230	-2.6640e-007	2.5327e-006 (0.0016)
	5824.9200	4.1565e-009	-1.0129e-006 1.2527e-006 (0.0011)

Everglades National Park--Osceola Camp GPS Adjustment (Continued)

AC4450 to AC4743 (2)	8831.0390	3.1074e-007	(0.0006)
	4305.2200	-1.6068e-007	1.6600e-006 (0.0013)
	5824.9260	9.2403e-008	-5.4809e-007 6.4638e-007 (0.0008)
AC4450 to C546 (1)	3824.0170	3.3440e-007	(0.0006)
	3478.2730	-1.8974e-007	1.7443e-006 (0.0013)
	5828.7110	1.0963e-007	-5.6357e-007 6.6786e-007 (0.0008)
AC4450 to C546 (2)	3824.0240	6.3212e-007	(0.0008)
	3478.2790	-4.0326e-007	2.3609e-006 (0.0015)
	5828.7040	7.6899e-008	-9.2258e-007 9.8419e-007 (0.0010)
AC4450 to OSCI (1)	247.7780	6.6765e-007	(0.0008)
	2853.5060	-3.3646e-007	3.2715e-006 (0.0018)
	5755.1150	7.2410e-008	-1.2595e-006 1.1570e-006 (0.0011)
AC4450 to OSCI (2)	247.7700	4.3775e-007	(0.0007)
	2853.5220	-3.0438e-007	2.3932e-006 (0.0015)
	5755.1210	1.5746e-007	-7.8969e-007 7.7406e-007 (0.0009)
AC4743 to C546 (1)	-5007.0180	5.6984e-007	(0.0008)
	-826.9480	-3.2246e-007	2.0020e-006 (0.0014)
	3.7850	4.1288e-008	-7.8730e-007 9.4577e-007 (0.0010)
AC4743 to C546 (2)	-5007.0200	2.9664e-007	(0.0005)
	-826.9520	-1.7240e-007	1.5355e-006 (0.0012)
	3.7880	9.8675e-008	-4.9653e-007 5.9224e-007 (0.0008)
AC4743 to OSCI (1)	-8583.2680	2.2110e-006	(0.0015)
	-1451.7250	-1.3886e-006	2.9021e-006 (0.0017)
	-69.8050	2.2770e-007	-6.6224e-007 1.1514e-006 (0.0011)
AC4743 to OSCI (2)	-8583.2680	4.8045e-007	(0.0007)
	-1451.7040	-3.4129e-007	2.6017e-006 (0.0016)
	-69.8030	1.7535e-007	-8.5930e-007 8.4823e-007 (0.0009)
C546 to OSCI (1)	-3576.2450	3.8622e-007	(0.0006)
	-624.7600	-2.7415e-007	2.0848e-006 (0.0014)
	-73.5840	1.4094e-007	-6.8895e-007 6.8216e-007 (0.0008)
C546 to OSCI (2)	-3576.2530	1.3190e-006	(0.0011)
	-624.7670	-8.8551e-007	1.9994e-006 (0.0014)
	-73.5870	1.8526e-007	-4.8323e-007 7.1551e-007 (0.0008)

Everglades National Park--Osceola Camp GPS Adjustment (Continued)

```

*****
      OUTPUT VECTOR RESIDUALS (East, North, Height - Local Level)
*****
SESSION NAME      -- RE --    -- RN --    -- RH --    - PPM -    DIST - STD -
                   (m)         (m)         (m)         (m)         (km)  (m)
AC0511 to AC4450 (1)  -0.0027    0.0033    -0.0053     0.994     6.9  0.0076
AC0511 to AC4450 (2)   0.0072   -0.0081     0.0045     1.707     6.9  0.0112
AC0511 to AC4743 (1)  -0.0015    0.0024    -0.0093     0.841    11.6  0.0092
AC0511 to AC4743 (2)   0.0033   -0.0036     0.0033     0.512    11.6  0.0121
AC0511 to C546 (1)   -0.0004    0.0016   -0.0078     1.229     6.5  0.0092
AC0511 to C546 (2)   -0.0023   -0.0026     0.0033     0.744     6.5  0.0109
AC0511 to OSCI (1)    0.0011   -0.0010     0.0061     2.202     2.9  0.0100
AC0511 to OSCI (2)    0.0087    0.0075     0.0138     6.288     2.9  0.0134
AC4421 to AC0511 (1)  -0.0025    0.0036   -0.0199     1.541    13.2  0.0220
AC4421 to AC0511 (2)   0.0046    0.0001     0.0056     0.553    13.2  0.0149
AC4421 to AC4450 (1)  -0.0055    0.0033   -0.0248     1.395    18.3  0.0203
AC4421 to AC4450 (2)   0.0135   -0.0018     0.0157     1.131    18.3  0.0160
AC4421 to AC4743 (1)  -0.0075    0.0037   -0.0129     1.280    12.0  0.0157
AC4421 to AC4743 (2)   0.0076   -0.0035     0.0111     1.160    12.0  0.0125
AC4421 to C546 (1)   -0.0078    0.0030   -0.0094     1.118    11.2  0.0202
AC4421 to C546 (2)    0.0030   -0.0026     0.0113     1.068    11.2  0.0114
AC4421 to OSCI (1)   -0.0105   -0.0003   -0.0078     1.091    12.0  0.0213
AC4421 to OSCI (2)    0.0061    0.0009     0.0172     1.517    12.0  0.0144
AC4450 to AC4743 (1)  -0.0040    0.0031   -0.0007     0.452    11.4  0.0120
AC4450 to AC4743 (2)   0.0024   -0.0014   -0.0051     0.509    11.4  0.0092
AC4450 to C546 (1)    0.0043   -0.0018   -0.0022     0.658     7.8  0.0094
AC4450 to C546 (2)   -0.0036    0.0024     0.0052     0.868     7.8  0.0114
AC4450 to OSCI (1)   -0.0049    0.0083   -0.0055     1.723     6.4  0.0129
AC4450 to OSCI (2)    0.0004   -0.0045     0.0073     1.343     6.4  0.0108
AC4743 to C546 (1)   -0.0019    0.0003     0.0015     0.476     5.1  0.0107
AC4743 to C546 (2)    0.0007   -0.0008   -0.0031     0.645     5.1  0.0089
AC4743 to OSCI (1)    0.0014    0.0085   -0.0117     1.668     8.7  0.0143
AC4743 to OSCI (2)   -0.0020   -0.0023     0.0061     0.785     8.7  0.0113
C546 to OSCI (1)     -0.0044   -0.0041   -0.0014     1.709     3.6  0.0101
C546 to OSCI (2)     0.0046    0.0010   -0.0052     1.925     3.6  0.0115

```

30 baseline residuals

RMS 0.0053 0.0038 0.0099
\$ - This session is flagged as a 3-sigma outlier

```

*****
      CHECK POINT RESIDUALS (East, North, Height - Local Level)
*****

```

```

STA. NAME      -- RE --    -- RN --    -- RH --
                (m)         (m)         (m)
AC0511          0.1149    0.0706    0.0205
-----
RMS             0.1149    0.0706    0.0205

```

AC0511 Check Point ... note large residuals relative to published X-Y coordinates

```

*****
      CONTROL POINT RESIDUALS (ADJUSTMENT MADE)
*****

```

```

STA. NAME      -- RE --    -- RN --    -- RH --
                (m)         (m)         (m)
AC4421         -0.0022   -0.0003    0.0023
AC4450          0.0022    0.0003
AC4743                          0.0013
C546                          -0.0037
-----
RMS             0.0022    0.0003    0.0026

```

Note that only AC4421 was fixed in X-Y-Z. AC4450 in X-Y. AC4743 & C546 in Z only.

Everglades National Park--Osceola Camp GPS Adjustment (Continued)

OUTPUT STATION COORDINATES (LAT/LONG/HT)

STA_ID	--	LATITUDE	--	LONGITUDE	--	ELLHGT	-	ORTHOHGT
AC0511	25	45	43.46914	-80	41	35.16782	-20.7955	3.4857
AC4421	25	51	44.92958	-80	37	19.81882	-19.3227	5.1525
AC4450	25	42	11.38118	-80	40	18.10054	-20.4271	3.8297
AC4743	25	45	41.52892	-80	34	40.34114	-22.0057	2.4627
C546	25	45	41.66302	-80	37	42.45544	-21.8467	2.5379
OSCI	25	45	39.01186	-80	39	52.72863	-22.1036	2.2219

OUTPUT STATION COORDINATES (GRID)

STA_ID	-	EASTING	-	NORTHING	-	ELLHGT	-	ORTHOHGT
		(m)		(m)		(m)		(m)
AC0511	230785.8193	158293.4066	-20.7955	3.4857				
AC4421	237869.1636	169434.8382	-19.3227	5.1525				
AC4450	232949.5269	151772.2488	-20.4271	3.8297				
AC4743	242345.1457	158265.6645	-22.0057	2.4627				
C546	237270.4892	158254.5151	-21.8467	2.5379				
OSCI	233640.6253	158163.2008	-22.1036	2.2219				

OUTPUT STATION COORDINATES (ECEF)

STA_ID	----	X	----	Y	----	Z	----
		(m)		(m)		(m)	
AC0511	929550.8543	-5672146.7997	2755337.8280				
AC4421	935783.0819	-5666214.3355	2765352.0545				
AC4450	932129.4576	-5674595.6260	2749458.6067				
AC4743	940960.4983	-5670290.4017	2755283.5292				
C546	935953.4786	-5671117.3512	2755287.3151				
OSCI	932377.2294	-5671742.1124	2755213.7268				

OUTPUT VARIANCE/COVARIANCE

STA_ID	SE/SN/SUP	----- CX matrix (m)-----			
	(95.00 %)	(not scaled by confidence level)			
	(m)	(ECEF, XYZ cartesian)			
AC0511	0.0093	1.4361e-005			
	0.0094	-1.9537e-007	1.7159e-005		
	0.0103	-2.3383e-010	-1.1162e-006	1.5425e-005	
AC4421	0.0089	1.3301e-005			
	0.0090	6.4995e-008	1.3740e-005		
	0.0091	-8.5067e-008	-9.1607e-008	1.3432e-005	

Everglades National Park--Osceola Camp GPS Adjustment (Continued)

```

AC4450      0.0089  1.3402e-005
            0.0090  -5.5987e-007  1.7644e-005
            0.0106  2.2196e-007  -2.0083e-006  1.4373e-005

AC4743      0.0093  1.4464e-005
            0.0094  2.7930e-007  1.2905e-005
            0.0086  -2.7758e-007  1.0199e-006  1.4280e-005

C546        0.0093  1.4373e-005
            0.0094  3.2785e-007  1.2859e-005
            0.0086  -2.8629e-007  9.9338e-007  1.4100e-005

OSCI        0.0094  1.4906e-005
            0.0095  -6.0164e-007  1.8449e-005
            0.0107  1.3502e-007  -1.3032e-006  1.5374e-005
    
```

 VARIANCE FACTOR = 1.0042

Note: Values < 1.0 indicate statistics are pessimistic, while values > 1.0 indicate optimistic statistics. Entering this value as the network adjustment scale factor will bring variance factor to one.

 Project: 02157A: Survey 02-157 MODIFIED WATER DELIVERIES-OSCEOLA
 CAMP-C&SF
 Program: GrafNet Version 6.03b
 Source: Network Adjustment
 CoordType: U.S. State Plane for FL East (901)
 Units(h,v): U.S. Survey Feet
 Geoid: Geoid99-ContUS.wpg
 Datum: NAD83(90)/NAVD88/NGVD29

**Summary of
 Adjustment
 Results
 NAD 83 (90)
 &
 NAVD 88 and
 NGVD 29
 adjustments**

NAME	PID	EASTING	NORTHING	88 HGT	29 HGT
N 237	AC0511	-----	-----	11.436	12.969
BUZZARD	AC4421	780409.081	555887.465	16.905	18.433
TROOPER	AC4450	764268.573	497939.453	12.565	14.096
G 237 RESET	AC4743	795094.032	519243.268	8.080	9.615
C 546	AJ7754	778444.930	519206.688	8.326	9.855
OSC1	-----	766535.951	518907.101	7.290	8.821

NOTES:

1. Published vertical value for AJ7754 is a preliminary CERP line adjusted value.
2. Horizontal values observed for AC0511 did not match published values, nor did they fit with observations made for Survey 01-198. Data will be incorporated into the L-67 Network Surveys and re-evaluated.
3. See "02157A88.net" and "02157A29.net" for more network adjustment information.

11-21. Approximate Adjustments of GPS Networks

Simply constructed GPS networks used for establishing lower-order USACE control can be effectively adjusted using approximate adjustment techniques, or adjustments that approximate the more rigorous least-squares solution. Although least-squares solutions may be theoretically superior to approximate methods, the resultant differences between the adjustments are generally not significant from a practical engineering standpoint.

a. Given the high cost of commercial geodetic adjustment software, coupled with the adjustment complexity of these packages, approximate adjustment methods are allowed for in-house and contracted surveys.

b. In practice, any complex GPS survey network may be adjusted by approximate methods. If the main loop/line closures are good, redundant ties to other fixed network points may be used as checks rather than being rigidly adjusted.

c. In some cases it is not cost-effective to perform detailed and time-consuming least-squares adjustments on GPS project control surveys requiring only 1:5,000 or 1:10,000 engineering /construction /boundary location accuracy. If internal loop closures are averaging over 1:200,000, then selecting any simple series of connecting baselines for an approximate adjustment will yield adequate resultant positional and relative distance accuracies for the given project requirements. If a given loop/baseline series of say five points miscloses by 0.01 ft over 1,000 m (1:100,000), a case can be made for not even making any adjustment if a relative accuracy of only 1:5,000 is required between points.

d. Any recognized approximate adjustment method may be used to distribute baseline vector misclosures. The method used will depend on the magnitude of the misclosure to be adjusted and the desired accuracy of the survey. These include the following:

(1) Simple proportionate distribution of loop/line position misclosures among the new station coordinates.

(2) Compass Rule.

(3) Transit Rule.

(4) Crandall Method.

(5) No adjustment. Use raw observations if misclosures are negligible.

e. Approximate adjustments are performed using the 3-D earth-centered X-Y-Z coordinates. The X-Y-Z coordinates for the fixed points are computed using the transform algorithms shown in the following paragraph or obtained from the baseline reduction software. Coordinates of intermediate stations are determined by using the baseline vector component differences (ΔX , ΔY , ΔZ), which are obtained directly from the baseline reductions. These differences are then accumulated (summed) forward around a loop or traverse connection, resulting in 3-D position coordinate misclosures at the loop nodes and/or tie points. These misclosures are then adjusted by any of the above methods. GPS vector weighting is accomplished within the particular adjustment method used; there is no need to incorporate the standard errors from the baseline reductions into the adjustment. Internal survey adequacy and acceptance are based on the relative closure ratios (e.g., 1:10,000), as in conventional traversing criteria (see FGCC 1984). Final local datum coordinates are then transformed back from the X-Y-Z coordinates.

f. Given a loop of baseline vectors between two fixed points (or one point looped back on itself), the following algorithms may be used to adjust the observed baseline vector components and compute the adjusted station geocentric coordinates.

(1) Given: Observed baseline vector components $\Delta X_i, \Delta Y_i, \Delta Z_i$ for each baseline " i " (total of n baselines in the loop/traverse). The three-dimensional length of each baseline is " l_i " and the total length of the loop/traverse is "L."

(2) The misclosures (dx, dy, and dz) in all three coordinates are computed from:

$$dx = X_F + \sum \Delta X_i - X_E$$

$$dy = Y_F + \sum \Delta Y_i - Y_E$$

$$dz = Z_F + \sum \Delta Z_i - Z_E \quad (\text{Eq 11-1})$$

Where $X_F, Y_F,$ and Z_F are the fixed coordinates of the starting point, $X_E, Y_E,$ and Z_E are the coordinates of the end point of the loop/traverse, and $\Delta X_i, \Delta Y_i,$ and ΔZ_i are summed from $i = 1$ to n . (These misclosures would also be used to assess the internal accuracy of the work.)

(3) Adjustments ($\delta x_i, \delta y_i, \delta z_i$) to each baseline vector component may be computed using either the Compass Rule:

$$\delta x_i = -dx [l_i / L] \quad (\text{Eq 11-2})$$

$$\delta y_i = -dy [l_i / L]$$

$$\delta z_i = -dz [l_i / L]$$

or the Transit Rule:

$$\delta x_i = -dx [\Delta x_i / \sum \Delta x_i] \quad (\text{Eq 11-3})$$

$$\delta y_i = -dy [\Delta y_i / \sum \Delta y_i]$$

$$\delta z_i = -dz [\Delta z_i / \sum \Delta z_i]$$

(4) The adjusted vector components are computed from:

$$\Delta X_i^a = \Delta X_i + \delta x_i \quad (\text{Eq 11-4})$$

$$\Delta Y_i^a = \Delta Y_i + \delta y_i$$

$$\Delta Z_i^a = \Delta Z_i + \delta z_i$$

(5) The final geocentric coordinates are then computed by summing the adjusted vector components from Equation 11-4 above:

$$X_i^a = X_F + x_i \Sigma \Delta x_i^a \quad (\text{Eq 11-5})$$

$$Y_i^a = Y_F + y_i \Sigma \Delta y_i^a$$

$$Z_i^a = Z_F + z_i \Sigma \Delta z_i^a$$

g. Example of an approximate GPS survey adjustment:

(1) Fixed control points from the US Army Yuma Proving Ground GPS Survey (May 1990) (see Figure 11-9):

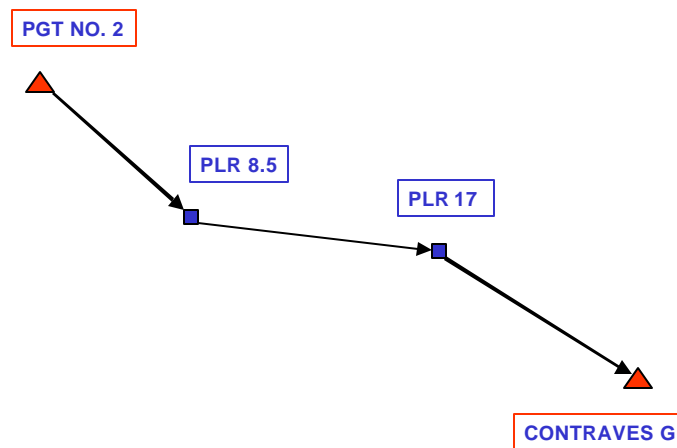

Figure 11-9. US Army Yuma Proving Ground GPS Traverse Sketch

<u>PGT NO 2</u>	<u>CONTRAVES G</u>
$X_F = (-) 2205\ 949.0762$	$X_E = (-) 2188\ 424.3707$
$Y_F = (-) 4884\ 126.7921$	$Y_E = (-) 4897\ 740.6844$
$Z_F = + 3447\ 135.1550$	$Z_E = + 3438\ 952.8159$

(XYZ geocentric coordinates were computed from GP-XYZ transform using Equations 11-6 and 11-7 below).

l_a, l_b, l_c = observed GPS baseline vectors (from baseline reductions) and PLR 8.5 and PLR 17 are the points to be adjusted.

(2) Misclosures in X, Y, and Z (computed from Equation 11-1):

(-)2205 949.0762	X _F	(-) 4884 126.7921	Y _F	3447 135.1550	Z _F
+3 777.9104	ΔX _a	(-) 6 006.8201	ΔY _a	(-)6 231.5468	ΔZ _a
+7 859.4707	ΔX _b	(-) 3 319.1092	ΔY _b	+ 400.1902	ΔZ _b
+5 886.8716	ΔX _c	(-) 4 288.9638	ΔY _c	(-)2 350.2230	ΔZ _c
(-)2188 424.3707	X _E	(-) 4897 740.6844	Y _E	- 3438952.8159	Z _E
<hr/>		<hr/>		<hr/>	
dx = <u>(-) 0.4528</u>		dy = <u>(-) 1.0008</u>		dz = <u>+ 0.7595</u>	

(3) Linear 3-D Misclosure:

$$= (0.45282 + 1.00082 + 0.75952)^{1/2} = \underline{1.335 \text{ m}} \text{ or 1 part in } 25,638.2/1.335 = \underline{1:19,200}$$

(Note: This is a constrained misclosure check, not free)

(4) Compass rule adjustment:

(a) Compass Rule misclosure distribution:

l _a	= 9 443.869	l _a /L = 0.368
l _b	= 8 540.955	l _b /L = 0.333
l _c	= 7 653.366	l _c /L = 0.299
L	=25,638.190	Σ = 1.000

(b) Compass Rule adjustment to GPS vector components using Equation 11-2:

Vector	δx	δy	δz
A	0.1666	0.3683	(-) 0.2795
B	0.1508	0.3333	(-) 0.2529
C	<u>0.1354</u>	<u>0.2992</u>	<u>(-) 0.2271</u>
	(+0.4528)	(+1.0008)	((-) 0.7595) Check

(c) Adjusted baseline vectors (from Equation 11-4):

Vector	ΔX ^a	ΔY ^a	ΔZ ^a
A	3778.0770	(-)6006.4518	(-)6231.8263
B	7859.6215	(-)3318.7759	399.9373
C	5887.0070	(-)4288.6646	(-)2350.4501

(d) Final adjusted coordinates (Equation 11-5):

Point	X ^a	Y ^a	Z ^a
PGT No. 2	(-) 2205 949.0762	(-) 4884 126.7921	+ 3447 135.1550
PLR 8.5	(-) 2202 170.9992	(-) 4890 133.2439	+ 3440 903.3287
PLR 17	(-) 2194 311.3777	(-) 4893 452.0198	+ 3441 303.2660
Contraves G	(-) 2188 424.3707	(-) 4897 740.6844	+ 3438 952.8159 (Check)

(e) Adjusted geocentric coordinates are transformed to Φ, λ, h , using Equations 11-9 through 11-13 in the following section. Geographic coordinates may then be converted to local SPCS (either NAD 83 or NAD 27) project control using USACE program CORPSCON.

(5) Transit rule adjustment.

(a) Distribution of GPS vector misclosures using Equation 11-3:

$$\Sigma \Delta x_i = 3777.9104 + 7859.4707 + 5886.8716 = 17,524.2527$$

Similarly,

$$\Sigma \Delta y_i = 13,614.8931 \quad \text{and} \quad \Sigma \Delta z_i = 8,981.9600$$

$$\delta x_i = -dx \left[\Delta x_i / \Sigma \Delta x_i \right] = -(-) [0.4538/17,524.2527] \Delta x_i = +2.584 \times 10^{-5} \Delta x_i$$

Similarly,

$$\delta y_i = +7.351 \times 10^{-5} \Delta y_i \quad \text{and} \quad \delta z_i = (-) 8.456 \times 10^{-5} \Delta z_i$$

(b) Adjustments to baseline vector components using Transit Rule (Equation 11-3):

Vector	δx	δy	δz
A	0.0976	0.4415	(-) 0.5269
B	0.2031	0.2440	(-) 0.0338
C	0.1521	0.3153	(-) 0.1987
(check)	(0.4528)	(1.0008)	(- 0.7595)

(c) Adjusted baseline vectors (from Equation 11-4):

Vector	ΔX^a	ΔY^a	ΔZ^a
A	3 778.0080	(-)6 006.3786	(-)6 232.0737
B	7 859.6738	(-)3 318.8652	+ 400.1564
C	5 887.0237	(-)4 288.6485	(-)2 350.4217

(d) Final adjusted coordinates (computed from Equation 11-5):

Point	X^a	Y^a	Z^a
PGT No. 2	(-) 2 205 949.0762	(-) 4884 126.7921	+3447 135.1550
PLR 8.5	(-) 2 202 171.0682	(-) 4890 133.1707	+3440 903.0813
PLR 17	(-) 2 194 311.3944	(-) 4893 452.0359	+3441 303.2377
Contraves G	(-) 2 188 424.3707	(-) 4897 740.6844	+3438 952.8160

(6) Proportionate distribution adjustment method:

EM 1110-1-1003
1 Jul 03

(a) Vector misclosures are simply distributed proportionately over each of the three GPS baselines in the traverse:

$$\delta x = - (-) 0.4528 / 3 = + 0.1509$$

$$\delta y = - (-) 1.0008 / 3 = + 0.3336$$

$$\delta z = - (-) 0.7595 / 3 = (-) 0.2532$$

Vector	ΔX^a	ΔY^a	ΔZ^a
A	3778.0613	(-) 6006.4865	(-) 6231.8000
B	7859.6216	(-) 3318.7756	+ 399.9370
C	5887.0225	(-) 4288.6302	(-) 2350.4762

(b) Final adjusted coordinates:

Point	X^a	Y^a	Z^a
PLR 8.5	(-) 2202 171.0149	(-) 4890 133.2786	+3440 903.3550
PLR 17	(-) 2194 311.3933	(-) 4893 452.0542	+3441 303.2920

Note: Relatively large horizontal (2-D) misclosure (1:23,340) may be due to existing control inadequacies, not poor GPS baseline observations.

(c) Variances between adjusted coordinates yield relative accuracies well in excess of 1:20,000; thus, if project control requirements are only 1:10,000, then any of the three adjustment methods may be used. The recommended method is the Compass Rule. Fixed coordinates of PGT No. 2 and CONTRAVES G can be on any reference ellipsoid--NAD 27 or NAD 83.

11-22. Geocentric Coordinate Conversions

The following algorithms for transforming between geocentric and geographic coordinates can be performed in the field on a hand-held calculator.

a. Geodetic to Cartesian coordinate conversion. Given geodetic coordinates on NAD 83 (in Φ , λ , H) or NAD 27, the geocentric Cartesian coordinates (X, Y, and Z) on the WGS 84, GRS 80, or Clarke 1866 ellipsoid are converted directly by the following formulas.

$$\begin{aligned} X &= (R_N + h) \cos \Phi \cos \lambda \\ Y &= (R_N + h) \cos \Phi \sin \lambda \\ Z &= ((b^2/a^2) R_N + h) \sin \Phi \end{aligned} \quad (\text{Eq 11-6})$$

where

Φ = latitude in degrees

λ = 360 degrees - λ_w (for CONUS west longitudes)

h = the ellipsoidal elevation. If only the orthometric elevation H is known, then that value may be used.

R_N = the normal radius of curvature

R_N can be computed from either of the following formulas:

$$R_N = (a^2) / [a^2 \cos^2 \Phi + b^2 \sin^2 \Phi]^{1/2} \quad (\text{Eq 11-7})$$

$$\text{or } R_N = (a) / [1 - e^2 \sin^2 \Phi]^{1/2} \quad (\text{Eq 11-8})$$

and

a (GRS 80) = 6,378,137.0 m (semimajor axis)
a (WGS 84) = 6,378,137.0 m
a (NAD 27) = 6,378,206.4 m

b (GRS 80) = 6,356,752.314 1403 m (semiminor axis)
b (WGS 84) = 6,356,752.314 m
b (NAD 27) = 6,356,583.8 m

f (GRS 80) = 1/298.257 222 100 88 (flattening)
f (WGS 84) = 1/298.257 223 563
f (NAD 27) = 1/294.978 698

e^2 (GRS 80) = 0.006 694 380 222 90 (eccentricity squared)
 e^2 (WGS 84) = 0.006 694 379 9910
 e^2 (NAD 27) = 0.006 768 658

NAD 27 = Clarke Spheroid of 1866
GRS 80 \approx NAD 83 reference ellipsoid

also

$$b = a (1 - f)$$

$$e^2 = f(2 - f) = (a^2 - b^2) / a^2$$

$$e^2 = (a^2 - b^2) / b^2$$

b. Cartesian to geodetic coordinate conversion. In the reverse case, given GRS 80 X, Y, Z coordinates, the conversion to NAD 83 geodetic coordinates (Φ , λ , H) is performed using the following noniterative method:

$$\lambda = \arctan (Y/X) \quad (\text{Eq 11-9})$$

The latitude " Φ " and height "h" are computed using the following sequence. The initial reduced latitude β_0 is first computed:

$$\beta_0 = [Z/p] [(1 - f) + (e^2 a / r)] \quad (\text{Eq 11-10})$$

where

$$p = [X^2 + Y^2]^{1/2}$$

$$e^2 = 2f - f^2$$

$$r = [p^2 + Z^2]^{1/2}$$

Directly solving for Φ and h:

$$\tan \Phi = [Z(1 - f) + e^2 a \sin^3 \beta_0] / [(1 - f)(p - a e^2 \cos^3 \beta_0)] \quad (\text{Eq 11-11})$$

$$h^2 = (p - a \cos \beta)^2 + (Z - b \sin \beta)^2 \quad (\text{Eq 11-12})$$

where the final reduced latitude " β " is computed from:

$$\tan \beta = (1 - f) \tan \Phi \quad (\text{Eq 11-13})$$

c. Transforms between other OCONUS datums may be performed by changing the ellipsoidal parameters "a," "b," and "f" to that datum's reference ellipsoid.

d. Example geocentric-geographic coordinate transform

Geographic to geocentric (Φ, λ, h to X, Y, Z) transform:

(1) Given any point:

$$\Phi_N = 35 \text{ deg } 27' 15.217''$$

$$\lambda_W = 94 \text{ deg } 49' 38.107'' \quad \text{then } \lambda = 360 \text{ deg} - \lambda_W = 265.1727481 \text{ deg}$$

$$h = 100 \text{ m} \quad (N = 0 \text{ assumed})$$

(2) Given constants (WGS 84):

$$\begin{aligned} a &= 6,378,137 \text{ m} & b &= a(1 - f) = 6,356,752.314 \\ f &= 1/298.257223563 & e^2 &= f(2 - f) = 6.694380 \times 10^{-3} \end{aligned}$$

e. Geocentric (X, Y, Z) to geographic (Φ, λ, H) transform.

Inversing the above X, Y, Z geocentric coordinates:

$$p = (X^2 + Y^2)^{1/2} = 5,201,440.106 \quad \text{and} \quad r = (p^2 + Z^2)^{1/2} = 6,371,081.918$$

$$\beta_0 = \tan^{-1} [Z / p] [(1 - f) + (e^2 a / r)] = 35.36295229 \text{ deg}$$

$$\tan \Phi = [Z (1 - f) + e^2 a \sin^3 \beta_0] / [(1 - f) (p - a e^2 \cos^3 \beta_0)] = 0.712088398$$

$$\text{then} \quad \Phi = 35.45422693 \text{ deg} = 35 \text{ deg } 27' 15.217''$$

$$\lambda = \tan^{-1} (Y/X) = 85.17274810 \text{ deg} \text{ or } 265.17274810 \text{ deg}$$

$$\text{then} \quad \lambda_w = 360 \text{ deg} - \lambda = 94 \text{ deg } 49' 38.107''$$

$$\beta = \tan^{-1} [(1 - f) \tan \Phi] = 35.36335663 \text{ deg}$$

$$h^2 = (p - a \cos \beta)^2 + (Z - b \sin \beta)^2 = (81.458)^2 + (58.004)^2$$

$$\text{then} \quad h = 99.999 = 100 \text{ m}$$

f. North American Datum of 1927 (Clarke Spheroid of 1866). Given a point with SPCS/Project coordinates on NAD 27, the point may be converted to X, Y, Z coordinates for use in subsequent adjustments.

$$\Phi_N = 35 \text{ deg } 27' 15.217'' \quad \lambda_w = 94 \text{ deg } 49' 38.107'' \quad h \text{ or } H = 100 \text{ m}$$

(NAD 27 from SPCS X-Y to Φ - λ conversion using USACE program CORPSCON)

$$\begin{aligned} a &= 6,378,206.4 & b &= 6,356,583.8 & f &= 1/294.978698 & e^2 &= 0.006768658 \\ & & & & & & & \text{(NAD 27/Clarke 1866 Spheroid)} \end{aligned}$$

$$\text{then} \quad R_N = (a) / [1 - e^2 \sin^2 \Phi]^{1/2} = 6392 \text{ } 765.205 \text{ m}$$

$$X = (R_N + h) \cos \Phi \cos \lambda = (-) 438 \text{ } 220.073 \text{ m}$$

$$Y = (R_N + h) \cos \Phi \sin \lambda = (-) 5189 \text{ } 023.612 \text{ m}$$

$$Z = ((b^2/a^2) R_N + h) \sin \Phi = + 3733 \text{ } 466.852 \text{ m}$$

These geocentric coordinates (on NAD 27 reference) may be used to adjust subsequent GPS baseline vectors observed on WGS 84.

11-23. Evaluation of Adjustment Results

A survey shall be classified based on its horizontal point closure ratio, as indicated in Table 11-2 or the vertical elevation difference closure standard given in Table 11-3. Other criteria pertaining to the results in free and constrained adjustments were given in Table 11-1.

a. Horizontal control standards. The horizontal point closure is determined by dividing the linear distance misclosure of the survey into the overall circuit length of a traverse, loop, or network line/circuit. When independent directions or angles are observed, as on a conventional survey (i.e. traverse, trilateration, or triangulation), these angular misclosures may optionally be distributed before assessing positional misclosure. In cases where GPS vectors are measured in geocentric coordinates, then the three-dimensional positional misclosure is assessed.

Table 11-2. USACE Point Closure Standards for Horizontal Control Surveys

USACE Classification	Point Closure Standard (Ratio)
Second Order Class I	1:50,000
Second Order Class II	1:20,000
Third Order Class I	1:10,000
Third Order Class II	1: 5,000
4th Order - Construction Layout	1: 2,500 - 1:20:000

Table 11-3. USACE Point Closure Standards for Vertical Control Surveys

USACE Classification	Point Closure Standard (Millimeters)
Second Order Class I	6 mm $K^{1/2}$
Second Order Class II	8 mm $K^{1/2}$
Third Order	12 mm $K^{1/2}$
4th Order - Construction Layout	24 mm $K^{1/2}$

(K is distance in kilometers)

(1) Approximate surveying. Approximate surveying work should be classified based on the survey's estimated or observed positional errors. This would include absolute GPS and some differential GPS techniques with positional accuracies ranging from 10 to 150 feet (95 %). There is no order classification for such approximate work.

(2) Higher-order surveys. Requirements for relative line accuracies exceeding 1:50,000 are rare for most USACE applications. Surveys requiring accuracies of First-Order (1:100,000) or better should be performed using FGCS standards and specifications, and must be adjusted by the National Geodetic Survey (NGS).

(3) Construction layout or grade control (Fourth-Order). This classification is intended to cover temporary control used for alignment, grading, and measurement of various types of construction, and some local site plan topographic mapping or photo mapping control work. Accuracy standards will vary with the type of construction. Lower accuracies (1:2,500 - 1:5,000) are acceptable for earthwork, dredging, embankment, beach fill, levee alignment stakeout and grading, and some site plan, curb and gutter, utility building foundation, sidewalk, and small roadway stakeout. Moderate accuracies (1:5,000) are used in most pipeline, sewer, culvert, catch basin, and manhole stakeout, and for general residential building foundation and footing construction, major highway pavement, and concrete runway stakeout work. Somewhat higher accuracies (1:10,000 - 1:20,000) are used for aligning longer bridge spans, tunnels, and large commercial structures. For extensive bridge or tunnel projects, 1:50,000 or even 1:100,000 relative accuracy alignment work may be required. Vertical grade is usually observed to the nearest 0.005 meter for most construction work, although 0.04-meter accuracy is sufficient for rip rap placement, grading, and small diameter pipe placement. Construction control points are typically marked by semi-permanent or temporary monuments (e.g., plastic hubs, P-K nails, wooden grade stakes). Control may be established by short, nonredundant spur shots, using total stations or GPS, or by single traverse runs between two existing permanent control points. Positional accuracy will be commensurate with, and relative to, that of the existing point(s) from which the new point is established.

b. Vertical control standards. The vertical accuracy of a survey is determined by the elevation misclosure within a level section or level loop. For conventional differential or trigonometric leveling, section or loop misclosures (in millimeters) shall not exceed the limits shown in Table 11-3, where the line or circuit length (K) is measured in kilometers. Fourth-Order accuracies are intended for construction layout grading work. Procedural specifications or restrictions pertaining to vertical control surveying methods or equipment should not be over-restrictive.

11-24. Final Adjustment Reports, Submittals, and Metadata

a. A variety of free and/or constrained adjustment combinations may be specified for a contracted GPS survey. Specific stations to be held fixed may be indicated or a contractor may be instructed to determine the optimum adjustment, including appropriate weighting for constrained points. When fixed stations are to be partially constrained, then appropriate statistical information must be provided--either variance-covariance matrices or relative positional accuracy estimates which may be converted into approximate variance-covariance matrices in the constrained adjustment. All rejected observations will be clearly indicated, along with the criteria/reason used in the rejection.

b. When different combinations of constrained adjustments are performed due to indications of one or more fixed stations causing undue biasing of the data, an analysis shall be made as to a recommended solution that provides the best fit for the network. Any fixed control points that should be readjusted due to anomalies from the adjustment(s) should be clearly indicated in a final analysis recommendation.

c. The final adjusted horizontal and/or vertical coordinate values shall be assigned an accuracy classification based on the adjustment statistical results. This classification shall include both the resultant geodetic/Cartesian coordinates and the baseline differential results. The final adjusted coordinates shall state the 95 percent confidence region of each point and the accuracy in parts per million between all points in the network. The datum and/or SPCS will be clearly identified for all coordinate listings.

d. Final report coordinate listings may be required on hard copy as well as on a specified digital media. It is recommended that a scaled plot be submitted with the adjustment report showing the proper locations and designations of all stations established.

e. Final report format. The following outline is recommended for GPS project submittals involving extensive networks, geoid modeling, and adjustments. Formal reports are usually not required for local topographic site plan or construction stake out surveys where simple GPS "total station" RTK techniques are employed. Typical project reports submitted by A-E contractors are shown in Appendix E and Appendix J. These sample reports include applicable portions of the outline guidance below.

Recommended Outline for Survey Report Submittals

Section 1: General Project Description

-Overview of the project including location, purpose, and parties involved.

Section 2: Background

-Reason for project (more detailed description) and more specific location description including a map. Accuracy and deliverables should be discussed in this section.

Section 3: Project Planning

-How the project was planned including but not limited to: reconnaissance results; PDOP and satellite availability tools used; DGPS method(s) selected; feature and attribute standards selected.

Section 4: Data Collection

-Overview of how data was collected including but not limited to: Equipment used (make and model); data collection method(s) and/or techniques used; control points used (brief history of control, datums, recovery notes); amount of data collected; number of crews and personnel per crew; how long the data collection took; data processing/error checking performed in field.

Section 5: Data Processing

-How was the data processing was performed including but not limited to process followed.

Subsection 5.1: Baseline Processing:

-Software used; baseline processing results (summary); reprocessed baselines and reason for; parameters for baseline processing (elevation mask, type of ephemeris used); summary results or loop closures (if applicable).

Subsection 5.2: Network Adjustments:

-Software used; results of unconstrained adjustment, minimal constrained adjustment (show unconstrained known control compared against published coordinates), and fully constrained adjustment; summary of weights used, general statistics.

Section 6: Project Summary and Conclusion

-This section shall include a narrative of overall results of the processing, products produced, listing of deliverables being submitted, overall accuracy of the data collection (based on results from data processing section), problems encountered during data collection and data processing, recommendations for future data collection efforts of this type or in this area (lessons learned).

Section 7: Output and Reports from Software

-This section shall include the detailed reports and output from software packages used during the data processing. This section might have multiple subsections--e.g., one for each step in the processing that has output that is critical in evaluating results.

f. Metadata submittals. Metadata records should be created for observations and adjustments of project control established by GPS. Corps metadata policy and procedural references are contained in ER 1110-1-8156 (Policies, Guidance, and Requirements for Geospatial Data and Systems) and EM 1110-1-2909 (Geospatial Data and Systems). The following is a sample metadata file developed for a GPS PROSPECT training survey at the Corps Beville Center in Huntsville, AL

Sample Metadata File for a GPS Survey Observations

SurveyIV.met

Identification_Information:

Citation:

Citation_Information:

Originator: Survey IV(comp.)

Publication_Date: Unknown

Publication_Time: Unknown

Title: Field survey to densify geodetic control for civil works plans and specifications
for the Tom Bevill Center and adjacent facilities

Edition: FY02

Description:

Abstract:

This data set is the result of a GPS field survey performed
to develop geodetic control at specified locations within
the vicinity of the Tom Bevill Center, Huntsville, Alabama.

Purpose:

To set control to verify existing map data and to facilitate
future civil works projects adjacent to the Tom Bevill
Center

Time_Period_of_Content:

Time_Period_Information:

Range_of_Dates/Times:

Beginning_Date: 20020603

Ending_Date: 20020607

Currentness_Reference: Publication Date

Status:

Progress: Complete

Maintenance_and_Update_Frequency: Annually

Spatial_Domain:

Bounding_Coordinates:

West_Bounding_Coordinate: -086.645900

East_Bounding_Coordinate: -086.639310

North_Bounding_Coordinate: +34.732910

South_Bounding_Coordinate: +34.717664

Keywords:

Theme:

Theme_Keyword_Thesaurus: Tri - Service Spatial Data Standard

Theme_Keyword: Geodetic/Cadastral

Place:

Place_Keyword_Thesaurus: Geographic Names Information System

Place_Keyword: Tom Bevill Center

Access_Constraints: None

Use_Constraints:

These data were compiled for government use and
represents the results of data collection/processing for a
specific U.S. Army Corps of Engineers (USACE) activity.
The USACE makes no representation as to the suitability or
accuracy of these data for any other purpose and disclaims
any liability for errors that the data may contain. As such, it
is only valid for its intended use, content, time, and
accuracy specifications. While there are not explicit
constraints on the use of the data, please exercise
appropriate and professional judgment in the use and
interpretation of these data.

Sample Metadata File for a GPS Survey Observations (Continued)

Point_of_Contact:

Contact_Information:

Contact_Person_Primary:

Contact_Person: Diane M. Hollingshead

Contact_Organization: U.S. Army Corps of Engineers

Contact_Position: Survey IV Coordinator

Contact_Address:

Address_Type: mailing address

Address:

CEHR-P

P.O. Box 1600

City: Huntsville

State_or_Province: Alabama

Postal_Code: 35807-4301

Contact_Voice_Telephone: 256-895-7449

Native_Data_Set_Environment: ASCII Data

Data Quality Information:

Attribute_Accuracy:

Attribute_Accuracy_Report: Point attributes were supplied by USACE, Survey IV.

Logical_Consistency_Report: None

Completeness_Report: None

Positional_Accuracy:

Horizontal_Positional_Accuracy:

Horizontal_Positional_Accuracy_Report:

Points meet Third Order Class 1 horizontal accuracy as specified in EM1110-1-2909, Change 2, 1 Jul 98; Table 11-5, Design, Construction, Operation & Maintenance of Feature & Topographic Detail Plans.

Vertical_Positional_Accuracy:

Vertical_Positional_Accuracy_Report:

Points meet third order vertical accuracy as specified in EM1110-1-2909, Change 2, 1 Jul 98; Table 11-5, Design, Construction, Operation & Maintenance of Military Feature & Topographic Detail Plans.

Lineage:

Source_Information:

Source_Citation:

Citation_Information:

Originator: Survey IV(comp.)

Publication_Date: Unknown

Publication_Time: Unknown

Title: Field survey to densify geodetic control for civil works plans and specifications for the Tom Beville Center and adjacent facilities

Type_of_Source_Media: paper

Source_Time_Period_of_Content:

Time_Period_Information:

Single_Date/Time:

Calendar_Date: 20010604

Source_Currentness_Reference: Publication Date

Source_Citation_Abbreviation: None

Source_Contribution: Geodetic Control Points

Sample Metadata File for a GPS Survey Observations (Continued)

Process_Step:

Process_Description:

The data for these points was collected with GPS and processed/adjusted with Trimble Geomatics Office software.

Process_Date: 20020606

Spatial Reference Information:

Horizontal_Coordinate_System_Definition:

Planar:

Grid_Coordinate_System:

Grid_Coordinate_System_Name: State Plane Coordinate System 1983

State_Plane_Coordinate_System:

SPCS_Zone_Identifier: 0101

Transverse_Mercator:

Scale_Factor_at_Central_Meridian: 0.9999600000

Longitude_of_Central_Meridian: -085.833333

Latitude_of_Projection_Origin: +30.500000

False_Easting: 656166.667

False_Northing: 0.000

Planar_Coordinate_Information:

Planar_Coordinate_Encoding_Method: coordinate pair

Coordinate_Representation:

Abscissa_Resolution: .001

Ordinate_Resolution: .001

Planar_Distance_Units: Survey Feet

Geodetic_Model:

Horizontal_Datum_Name: North American Datum of 1983

Ellipsoid_Name: Geodetic Reference System 80

Semi-major_Axis: 6378137.000

Denominator_of_Flattening_Ratio: 298.257223563

Vertical_Coordinate_System_Definition:

Altitude_System_Definition:

Altitude_Datum_Name: North American Vertical Datum of 1988

Altitude_Resolution: .01

Altitude_Distance_Units: Meters

Altitude_Encoding_Method: Explicit elevation coordinate included with horizontal coordinates

Distribution Information:

Distributor:

Contact_Information:

Contact_Person_Primary:

Contact_Person: Jim Garster

Contact_Organization: U.S. Army Corps of Engineers

Contact_Position: Survey Engineer

Contact_Address:

Address_Type: mailing and physical address

Address:

ERDC

U.S. Army Topographic Engineering

Center

ERDC-TEC-VA

City: Alexandria

State_or_Province: Virginia

Postal_Code: 22315

Contact_Voice_Telephone: 703-428-6766

Sample Metadata File for a GPS Survey Observations (Continued)

Distribution_Liability:

These data were compiled for government use and represents the results of data collection/processing for a specific U.S. Army Corps of Engineers (USACE) activity. The USACE makes no representation as to the suitability or accuracy of these data for any other purpose and disclaims any liability for errors that the data may contain. As such, it is only valid for its intended use, content, time, and accuracy specifications. While there are not explicit constraints on the use of the data, please exercise appropriate and professional judgment in the use and interpretation of these data.

Standard_Order_Process:

Non-digital_Form:

For digital or non-digital data, contact Prospect Course Proponent

Fees: No charge

Metadata Reference Information:

Metadata_Date: 20020607

Metadata_Contact:

Contact_Information:

Contact_Person_Primary:

Contact_Person: Fran Woodward

Contact_Organization: U.S. Army Corps of Engineers

Contact_Position: Civil Engineering Technician

Contact_Address:

Address_Type: mailing address

Address:

CESAJ-CO-OM

P. O. Box 4970

City: Jacksonville

State_or_Province: Florida

Postal_Code: 32232-0019

Contact_Voice_Telephone: 904-232-1132

Metadata_Standard_Name: FGDC Content Standards for Digital Geospatial Metadata

Metadata_Standard_Version: FGDC-STD-001-1998

Metadata_Time_Convention: Local time

Metadata_Access_Constraints: None

Metadata_Use_Constraints:

These data were compiled for government use and represents the results of data collection/processing for a specific U.S. Army Corps of Engineers (USACE) activity. The USACE makes no representation as to the suitability or accuracy of these data for any other purpose and disclaims any liability for errors that the data may contain. As such, it is only valid for its intended use, content, time, and accuracy specifications. While there are not explicit constraints on the use of the data, please exercise appropriate and professional judgment in the use and interpretation of these data.

Not all metadata fields must be completed for a particular project. Figure 11-10 below shows the required and optional metadata sections. For example, the above sample metadata file used only sections 1, 2, 4, 6, and 7.

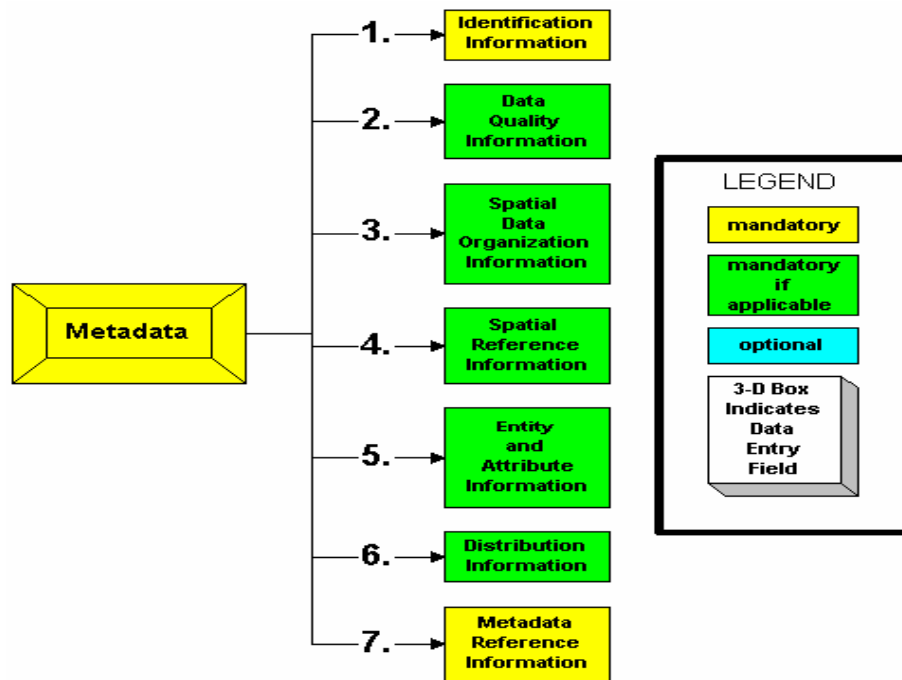

Figure 11-10. General Metadata format indicating sections 2 through 6 are optional

11-25. Mandatory Requirements

The criteria standards in Tables 11-1, 11-2, and 11-3 are considered mandatory.

Chapter 12 Contracting GPS Surveying Services

12-1. General

This chapter describes the process for contracting GPS survey services. It covers development of survey scopes of work, performance specifications, and cost estimates for Architect-Engineer (A-E) contracts. Procedures for developing GPS survey contract specifications and cost estimates are performed similarly to those for A-E design services. Similar technical discipline scheduling and production factors are used to determine the ultimate cost of a task. Although this chapter is intended to provide guidance for estimating costs for GPS surveying services, the explanations herein regarding procurement policies and practices describe only the framework within which cost estimates are used. For detailed guidance on procurement policies and practices, refer to the appropriate procurement regulations: FAR, DFARS, EFARS, EP 715-1-7 (Architect-Engineer Contracting), and the PROSPECT course on A-E contracting.

12-2. Brooks Architect-Engineer Act

In the Federal government, professional architectural, engineering, planning, and related surveying services must be procured under the Brooks Architect-Engineer Act, Public Law 92-582 (10 US Code 541-544). The Brooks A-E Act requires the public announcement of requirements for surveying services, and selection of the most highly qualified firms based on demonstrated competence and professional qualifications. Cost or pricing is not considered during the selection process. After selection, negotiation of a fair and reasonable price for the work is conducted with the highest qualified firm. GPS surveying supporting the Corps' research, planning, development, design, construction, or alteration of real property is considered to be a related or supporting architectural or engineering service, and must therefore be procured using Brooks A-E Act qualifications-based selection, not by bid price competition.

12-3. Contracting Processes and Procedures

Corps procedures for obtaining A-E services are based on a variety of Federal and DoD acquisition regulations. The following paragraphs synopses the overall A-E process used in the Corps.

a. Types of contracts. Two types of A-E contracts are principally used for surveying services: Firm-Fixed-Price (FFP) contracts and Indefinite Delivery contracts (IDC). FFP contracts are used for moderate to large mapping projects (e.g., > \$1 million) where the scope of work is known prior to advertisement and can be accurately defined during negotiations--typically for a large new project site. Due to variable and changing engineering and construction schedules (and funding), most mapping work involving GPS services cannot be accurately defined in advance; thus, these fixed-scope FFP contracts are rarely used, and well over 95% of surveying services are procured using IDC.

b. Announcements for surveying services. Requirements for surveying services are publicly announced and firms are given at least 30 days to respond to the announcement. The public announcement contains a brief description of the project, the scope of the required services, the selection criteria in order of importance, submission instructions, and a point-of-contact. This public announcement is not a request for price proposal, and firms are directed not to submit any price-related information.

c. Selection criteria. Federal and DoD regulations set the criteria for evaluating prospective surveying contractors as listed below. These criteria are listed in the public announcement in their order

of importance and the selection process assigns descending weights to each item in that order. (The order listed below may be modified based on specific project requirements.)

- (1) Professional qualifications necessary for satisfactory performance.
- (2) Specialized experience and technical competence in the type of work required.
- (3) Past performance on contracts with Government agencies and private industry in terms of cost control, quality of work, and compliance with performance schedules.
- (4) Capacity to perform the work in the required time.
- (5) Knowledge of the locality of the project.
- (6) Utilization of small or disadvantaged businesses.
- (7) Geographic location.
- (8) Volume of work awarded by the Department of Defense.

[Note: (6), (7), and (8) are secondary selection criteria--see EP 715-1-7 (Architect-Engineer Contracting) for latest policy on A-E selection procedures and evaluation criteria]

d. Selection process. The evaluation of firms is conducted by a formally constituted Selection Board in the Corps district seeking the services. This board is made up of highly qualified professional employees having experience in architecture, engineering, surveying, etc. A majority of the board members for surveying services must have specific technical expertise in that area. At least one member must be a licensed surveyor if real property surveys are involved. The board evaluates each of the firm's qualifications based on the advertised selection criteria and develops a list of at least three most highly qualified firms. As part of the evaluation process, the board conducts interviews with these top firms prior to ranking them. The firms are asked questions about their experience, capabilities, organization, equipment, quality management procedures, and approach to the project. These interviews are normally conducted by telephone. The top three (or more) firms are ranked and the selection is approved by the designated selection authority--typically the District Commander. The top ranked firms are notified they are under consideration for the contract. Unsuccessful firms are also notified, and are afforded a debriefing as to why they were not selected, if they so request.

e. Negotiations and award. The highest qualified firm ranked by the selection board is provided with a detailed scope of work for the project, project information, and other related technical criteria, and is requested to submit a detailed price proposal for performing the work. In the case of IDC, price proposals consist simply of unit rates for various disciplines, services, and equipment. This list becomes the contract "Schedule B" of prices, and typically each line item of services contains all overheads, profits, and incidental supplies. Once a fair and reasonable price (to the government) is negotiated, the contract is awarded. The Government Contracting Officer is obligated to strive to obtain a negotiated price that is "fair and reasonable" to both the Government and the contractor.

12-4. Indefinite Delivery Contracts and Task Orders

The vast majority of the Corps surveying services are procured using Indefinite Delivery Contracts (IDC). These IDCs are procured using the selection and negotiation process described above. IDC (once termed "Open-End" or "Delivery Order" contracts) have only a general scope of work--e.g., "GPS surveying services in Southeastern United States." When work arises during the term of the contract, task orders are written for performing that specific work. In the Corps, IDCs are currently (2002) issued for \$1 million

with two additional \$1 million option term (not year) extensions -- for a total award of \$3 million. Task orders may be issued up to \$1 million each. Larger IDC awards are often made, both in overall award size and task order limit. Task orders are negotiated using the unit rate "Schedule" developed for the main contract. Thus, negotiations are focused on the level of effort and performance period. Task orders typically have short scopes of work--a few pages. The scope is sent to a contractor who responds with a time and cost estimate, from which negotiations are initiated. Under emergency conditions (e.g., flood fights, hurricanes) contractors can be issued task orders verbally by the Contracting Officer, with the scope of work simply defined as a limiting number of days for survey crew at the contract schedule rate. The entire process--from survey need to task order award--should routinely take only 2 to 4 weeks. From the IDC Schedule, a GPS survey crew and equipment is pieced together using the various line items--adding or deducting personnel or equipment as needed for a particular project. A number of methods are used for scheduling GPS services in a fixed-price or IDC contract. The most common method is a Daily Rate. A daily rate basis is the cost for a GPS field crew (including all instrumentation, transport, travel, and overhead) over a nominal 8-hour day. A daily crew rate is the preferred unit price basis for estimating contracted GPS services for IDC contracts and their task orders. It provides the most flexibility for IDC contracts, especially when individual project scopes are expected to vary widely. The crew personnel size, number of GPS receivers deployed, vehicles, etc., must be explicitly indicated in the contract specifications, with differences resolved during negotiations. Options to add additional GPS receiver units (along with personnel and/or transport) must be accounted for in the estimate and unit price schedule. As an example, the daily rate for a GPS surveying crew could be estimated using the following detailed analysis method.

Table 12-1. Factors for Estimating A-E Costs

Item	Description
I	Direct labor or salary costs of GPS survey technicians: includes applicable overtime or other differentials necessitated by the observing schedule
II	Overhead on Direct Labor *
III	G&A Overhead Costs (on Direct Labor) *
IV	Material Costs
V	Travel and Transportation Costs: crew travel, per diem, etc. Includes all associated costs of vehicles used to transport GPS receivers
VI	Other Costs: includes survey equipment and instrumentation, such as GPS receivers. GPS receiver costs should be amortized down to a daily rate, based on average utilization rates, expected life, etc. Exclude all instrumentation and plant costs covered under G&A, such as interest
VII	Profit (Computed/ negotiated on individual task order or developed for all task orders in contract)

* these may be combined into a single overhead rate

12-5. Contract Price Schedule

The various personnel, plant and equipment cost items like those shown in Table 12-1 above are used as a basis for negotiating fees for individual line items in the basic IDC contract. During negotiations with the A-E contractor, individual components of the Independent Government Estimate (IGE) and the contractor's price proposal may be compared and discussed. Differences would be resolved in order to

EM 1110-1-1003
1 Jul 03

arrive at a fair and reasonable price for each line item. The contract may also schedule unit prices based on variable crew sizes and/or equipment. A typical negotiated IDC price schedule (i.e. Section B - Supplies or Services and Prices/Costs) is shown below in Table 12-2. The contract specifications would contain the personnel and equipment requirements for each line item. Each Corps district has its unique requirements and therefore line items used in schedules will vary considerably. For instance, some districts may elect to apply overhead as a separate line item. Others may compute profit separately for each task order and others may not include travel costs with crew rates.

Table 12-2. Sample Contract Schedule of Services for an Indefinite Delivery Contract used for GPS Surveying Services

Item	Description	Quantity	U/M	Unit Price
0001	Registered/Licensed Land Surveyor--Office	[1]	Day	\$ 497.31
0002	Registered/Licensed Land Surveyor--Field	[1]	Day	\$ 459.22
0005	Professional Geodesist Computer--Office	[1]	Day	\$ 415.76
0007	Engineering Technician (CADD Draftsman)--Office	[1]	Day	\$ 296.00
1003	Civil Engineering Technician--Field Supervisor	[1]	Day	\$ 245.00
1005	Supervisory GPS Survey Technician (Field)	[1]	Day	\$ 452.73
1006	Surveying Technician--GPS Instrumentman/Recorder	[1]	Day	\$ 374.19
1007	Surveying Aid--Rodman/Chainman	[1]	Day	\$ 246.94
1008	One-Person GPS RTK Survey Crew [two receivers--one vehicle--travel]	[1]	Day	\$1,323.76
1008a	Two-Person GPS Static or RTK Survey Crew [two receivers--one vehicle--travel]	[1]	Day	\$1,868.05
1008b	Three-Person GPS Static or RTK Survey Crew [three receivers--two vehicles--travel]	[1]	Day	\$2,234.72
1008c	Four-Person GPS Static or RTK Survey Crew [four receivers--three vehicles--travel]	[1]	Day	\$2,546.98
1101	Additional GPS receiver	[1]	Day	\$ 100.00
1102	Additional survey vehicle	[1]	Day	\$ 40.00
1013	Air Boat (Florida w/operator)	[1]	Day	\$ 330.00
1014	Marsh Buggy (Florida w/operator)	[1]	Day	\$ 360.00
1210	Station Monuments [standard concrete monument]	[1]	EA	\$ 25.00
1211	Station Monuments [deep rod vertical monument]	[1]	EA	\$ 950.00
1215	Bluebooking	[1]	BL	\$ 500.00
1300	Nominal Per diem [to be adjusted on each task order]	[1]	Day	[per JTR rate]

Abbreviations EA = Each BL=Baseline

Scheduled prices include overhead and profit [these could be listed separately if desired]

GPS survey crew includes all field equipment, auxiliary data loggers, tripods, and computers needed to observe, reduce, and adjust baselines in the field. Per diem is included. [The contract scope of work will specify items that are included with a crew, including GPS receiver quality standards]

12-6. Sample Cost Estimate for Contracted GPS Survey Services

The following cost computation is representative of the procedure used in preparing the IGE for an A-E contract and ultimately the contract price schedule above. The example shows the computation for a two-man GPS survey crew. Larger crew/receiver size estimates would be performed similarly. Costs and overhead percentages are shown for illustration only--they are subject to considerable geographic-, project-, and contractor-dependent variation (e.g., audited G&A rates could range from 50 to 200 percent). GPS instrumentation rates are approximate (2002) costs. Associated costs for GPS receivers, such as insurance, maintenance contracts, interest, etc., are presumed to be indirectly factored into a firm's G&A overhead account. If not, then such costs must be directly added to the basic equipment depreciation rates shown. Other equally acceptable accounting methods for developing daily costs of equipment may be used. Equipment utilization estimates in an IGE may be subsequently revised (during negotiations) based on actual rates as determined from a detailed cost analysis and field price support audits.

SAMPLE COMPUTATION FOR FULLY EQUIPPED 3-MAN GPS SURVEY CREW
[3 geodetic quality receivers, auxiliary equipment, 2-vehicles, laptops, and adjustment software]

LABOR

Supervisory Survey Tech (Party Chief)	\$42,776.00/yr (based on GS 11/5)	
Overhead on Direct Labor (36%)	\$15,399.36/yr	
G&A Overhead (115%)	<u>\$49,192.40/yr</u>	
Total:	\$107,367.76/yr	\$411.57/day *
Survey Technician--GPS observer	\$35,355/yr (based on GS 9/5)	
@ 151% O/H (36%+115%)	\$88,741.05	\$340.17/day
Survey Aid		\$23,332/yr (based on GS 5/5)
@ 151 % O/H	\$58,563.32	\$224.49/day

Total Labor Cost for 3-Man GPS Crew/day: **\$976.23**

*[adding 10% profit = \$452.73 --Schedule B]

TRAVEL (NOMINAL RATE)

Per Diem (Nominal): 3 persons @ \$ 88/day
(subject to JTR adjustment on task orders)

Total Travel Cost/day: **\$264.00**

SURVEY INSTRUMENTATION & EQUIPMENT

DGPS Carrier Phase Positioning System --3 geodetic quality receivers (static or kinematic positioning), batteries, tripods, data collectors, etc.	\$40,000 ea or \$120,000 @ 4 yrs @ 100 d/yr	\$300/day
Total Station: data collector, prisms, etc.	\$32,000 @ 5 yrs @ 120 d/yr (rental rate: \$60/d)	\$ 53/day
Survey Vehicle	\$40,000 ea @ 6 yrs @ 225 d/yr plus O&M @ 2 reqd	\$ 80/day
Misc Materials (field books, survey supplies, etc)		\$ 25/day

Total Instrumentation & Equipment Cost/day: **\$ 458.00**

Subtotal : \$ 1,698.23
Profit @ 10.0% \$ 169.82

Total Estimated Cost per Day -- 3 man GPS Survey Crew \$ 1,868.05

Similar computations are made for other line items in the price schedule.

12-7. Cost Per Work Unit (GPS Station) Schedule

If a cost-per-work-unit fee structure is desired on an IDC, the computed daily/hourly crew rates and other applicable cost items can be divided by the estimated daily/hourly productivity in order to schedule work units. Typical work unit measures on a GPS contract might be cost per static point or cost per kinematic point. Both the estimated crew daily rate and the estimated productivity rates are subject to negotiation. An infinite number of work unit measures could be formed, given the variety in units of measure, survey classifications, expected local conditions, etc. Use of work unit rates is obviously restricted to individual project areas where work is fairly repetitious. Costs per GPS stations were commonly used during the early days of GPS (mid-1980s) when GPS receivers cost \$150,000 and only 3-4 hours of satellite constellation was available each day. Today there is little justification for using work unit costs for pricing GPS surveys.

12-8. Contract Specifications and Accuracy Standards

a. Contract specifications and standards for Corps surveying work should make maximum reference to existing standards, publications, and other references. The primary reference standard is this manual. Drafting and CADD/GIS standards are contained in various (Tri-Service) CADD/GIS Technology Center publications. Corps headquarters does not specify standard hardware or software for its districts--each district may establish their own standards based on their unique requirements. US Government policy prescribes maximum use of industry standards and consensus standards established by private voluntary standards bodies, in lieu of government-developed standards. This policy is further outlined in EM 1110-1-2909, as follows:

"Voluntary industry standards shall be given preference over non-mandatory Government standards. When industry standards are non-existent, inappropriate, or do not meet a project's functional requirement, ...[other] standards may be specified as criteria sources. Specifications for surveying and mapping shall use industry consensus standards established by national professional organizations, such as the American Society for Photogrammetry and Remote Sensing (ASPRS), the American Society of Civil Engineers (ASCE), the American Congress on Surveying and Mapping (ACSM), or the American Land Title Association (ALTA). Technical standards established by state boards of registration, especially on projects requiring licensed surveyors or mappers, shall be followed when legally applicable. Commands shall not develop or specify local surveying and mapping standards where industry consensus standards or Army standards exist."

b. According to Corps policy, technical specifications for obtaining GPS survey data shall be "performance-based" and not overly prescriptive or process oriented. Performance-based specifications shall be derived from the functional project requirements and use recognized industry standards where available. Performance-oriented (i.e. outcome based) specifications set forth the end results to be achieved (i.e. final drawing/chart format or accuracy standard) and not the means, or technical procedures, used to achieve those results. A performance-oriented specification provides the most flexibility and allows the most economical and efficient methods to achieve the desired end product. Performance specifications should succinctly define the basic mapping limits, feature location and attribute requirements, scale, contour interval, map format, sheet layout, and final data transmittal, archiving or storage requirements, the required accuracy criteria standards for topographic and planimetric features that are to be depicted, and describe quality assurance procedures that will be used to verify conformance with the specified criteria. Performance-oriented specifications should be free from unnecessary equipment, personnel, instrumentation, procedural, or material limitations; except as needed

to establish comparative cost estimates for negotiated services. This would include any in-progress reviews or approvals during various phases of the project.

c. EM 1110-1-2909 also states that use of prescriptive (i.e. procedural) specifications shall be kept to a minimum, and called for only on highly specialized or critical projects where only one prescribed technical method, in the opinion of the Government, is appropriate or practical to perform the work. Overly prescriptive specifications typically require specific field instrumentation (e.g., brand name GPS receiver), personnel, office adjustment procedures (e.g., product-specific software or output format), or rigid project phasing with on-going design or construction. Prescriptive specifications reduce flexibility, efficiency, and risk, and can adversely impact project costs if antiquated survey methods or instrumentation are required.

12-9. Contract Statements of Work

Technical specifications for GPS surveying that are specific to the project (including items such as the scope of work, procedural requirements, and accuracy requirements) are inserted in the appropriate section of the contract (e.g., Statement of Work--Section C). This GPS engineer manual should be attached to and made part of any A-E service or construction contract requiring GPS surveying. References to USACE survey classifications (and related criteria tables) may also be made if required. References to this manual will normally suffice for most USACE survey specifications; however, areas where deviations from (or additions to) this manual must be considered in developing the Statement of Work. A guide specification for GPS surveying services is found in Appendix C of this manual. This guide specification is readily adaptable to all types of GPS surveying services.

12-10. Contract Quality Control and Quality Assurance

Under the Corps professional contracting system, contractors are responsible for performing all quality control (QC) activities associated with their work. The Corps is responsible for quality assurance (QA) oversight of the contractor's QC actions. Therefore, Corps QA or testing functions should be focused on whether the contractor meets the required performance specification (e.g., survey accuracy) and not the intermediate surveying or compilation steps performed by the contractor. As a result, for surveys procured using the Brooks A-E Act qualifications-based selection method, Corps representatives do not regularly observe work in progress (i.e. perform QC activities)--the contractor was selected as being technically qualified to perform the work; including all QC associated with it. Corps-performed field testing of a contractor's work is an optional QA requirement, and should be performed only when technically and economically justified.

12-11. Task Order Time and Cost Estimates

Once unit prices have been negotiated and established in the basic IDC schedule as illustrated in the above sections, each IDC task order is negotiated primarily for effort, i.e. time. The process for estimating the time to perform any particular survey function in a given project is highly dependent on the knowledge and personal field experience of the government and contractor estimators. The negotiated fee on a task order is then a straight mathematical procedure of multiplying the agreed-upon effort against the established unit prices in Schedule B, plus an allowance for profit if not included in the unit rates. An IGE is required for task orders over \$100,000, along with a detailed profit computation, documented records of negotiations, etc. The scope is attached to a DD 1155 order placed against the basic contract. If a preliminary site investigation is scheduled for this project, any such adjustments should be investigated and resolved prior to negotiating subsequent task orders for the various phases of the work, to the maximum extent possible. As such, the negotiated costs for the subsequent work phases would be considered fixed price agreements. Any later adjustments to these agreed to prices would be issued in the

form of modifications to task orders (i.e. change orders), and would have to be rigorously defended as significant, unforeseen changes in the scope. The contractor would be expected to immediately notify the contracting officer (KO) or Contracting Officer's Technical Representative (COTR) of the need for cost adjustments.

12-12. Sample Task Order for GPS Services

Following is an example of a task order for GPS surveying services that are performed within a task order for monitoring a beach renourishment project. Included in this example is the letter request for proposal to the IDC contractor. Attached to this letter request is the detailed statement of work that identifies the scope, standards, and specifications that are to be performed. The final record of negotiations compares the Independent Government Estimate with the contractor's proposal, and records the final negotiated cost to perform the task order.

SAMPLE LETTER REQUEST FOR PROPOSAL

Engineering Division
Design Branch

Sea Systems, Inc.
3456 Northwest 27th Avenue
Pompano Beach, Florida 33069-1087

SUBJECT: Contract No. DACW17-98-D-0004

Gentlemen:

Enclosed are marked drawings depicting the scope of work required for the following project:

Brevard County, Sand Bypass System Post Construction
One-Year Monitoring Beach Erosion Survey
Canaveral Harbor, Florida (Survey 99-267)

General Scope. Furnish all personnel, plant, equipment, transportation, and materials necessary to perform and deliver the survey data below in accordance with the conditions set forth in Contract No. DACW17-98-D-0004. Services not specifically described herein are nonetheless a firm requirement, if they can be identified as an item or items commonly a part of the professional grade work of a comparative nature required by your contract. All work shall be accomplished in accordance with the Manuals and TM's specified in your contract.

Your attention is directed to the Site Investigation and Conditions Affecting the Work clause of your contract. After we have reached agreement on a price and time for performance of this work, neither the negotiated price nor the time for performance will be exchanged as a consequence of conditions at the site except in accordance with the clause. Costs associated with the site investigation are considered overhead costs which are reimbursed in the overhead rates included in your contract. Additional reimbursement will not be made.

a. Scope of Work. Hydrographic and topographic monitoring data shall be collected for CCAFS-29, CCAFS-30, CCAFS-33 through CCAFS-42, BC-5 through BC-14, and DEP R-0 through DEP R-18 including DEP R-1-AA and DEP R-1A. The area is shown on Enclosure 1, USGS quads. Enclosure 2 is the control monument descriptions and profile line azimuth. Enclosure 3 is the technical requirements for the surveys.

b. Data Processing. The Contractor shall make the necessary computations to verify the accuracy of all measurements and apply the proper theory of location in accordance with the law or precedent and publish the results of the survey.

c. CADD. The survey data shall be translated or digitally captured into Intergraph IGDS 3D design files according to the specifications furnished. The survey data shall be provided in Intergraph MicroStation Version 5.0 or higher.

d. Digital Geospatial Metadata. Metadata are "data about data". They describe the content, identification, data quality, spatial data organization, spatial reference, entity and attribute information, distribution, metadata reference, and other characteristics of data. Each survey project shall have metadata submitted with the final data submittal.

e. Compliance. Surveying and Mapping shall be in strict compliance with EM-1110-1-1000 Photogrammetric Mapping, EM-1110-1-1002 Survey Markers and Monumentation, EM-1110-1-1003 NAVSTAR Global Positioning System Surveying, EM-1110-1-1004 Deformation Monitoring and Control Surveying, EM-1110-1-1005 Topographic Surveying, EM-1110-2-1003 Hydrographic Surveying, EM-1110-1-2909 Geospatial Data and System, Tri-Services A/E/C CADD Standards, Tri-Services Spatial Data Standards, Related Spatial Data Products and Chapter 177, Chapter 472, and Chapter 61G17 of the Minimum Technical Standards set by the Florida Board of Professional Surveyors and Mappers.

The completion date for this assignment is 60 days after the Notice to Proceed is signed by the Contracting Officer.

Contact Design Branch at 904-232-1613 for assistance, questions, and requirements.

You are required to review these instructions and make an estimate in writing of the cost and number of days to complete the work. Please mark your estimate to the attention of Chief, Design Branch.

This is not an order to proceed with the work. Upon successful negotiation of this delivery order the Contracting Officer will issue the Notice to Proceed.

Sincerely,

Enclosures

Walter Clay Sanders, P.E.
Assistant Chief, Engineering Division

Sample Task Order Scope of Work--Sand Bypass Project

TECHNICAL QUALITY CONTROL REQUIREMENTS
BREVARD COUNTY, SAND BYPASS SYSTEM POST CONSTRUCTION
ONE-YEAR MONITORING BEACH EROSION SURVEY
CANAVERAL HARBOR, FLORIDA
(SURVEY 99-267)

1. LOCATION OF WORK. The project is located in Brevard County at Canaveral Harbor, Florida.

2. SCOPE OF WORK.

2a. The services to be rendered by the Contractor include obtaining topographic and hydrographic survey data (x, y, z,) and CADD data for 47 beach profile lines.

2b. The services to be rendered by the Contractor include all the work described in these technical requirements. Details not specifically described in these instructions are nevertheless a firm requirement if they can be identified as an item, or items, commonly a part of professional grade work of a comparative nature.

2c. The Contractor shall furnish all necessary materials, labor, supervision, equipment, and transportation necessary to execute and complete all work required by these specifications.

2d. The Corps of Engineers, Survey Section shall be contacted the same day that the Contractor plans to commence the work.

2e. Rights-of-Entry must be obtained verbally and recorded in the field book before entering on the private property. Enter in the field book the name and address of the property owner contacted for rights-of-entry.

EM 1110-1-1003

1 Jul 03

2f. COMPLIANCE. Surveying and Mapping shall be in strict compliance with EM-1110-1-1000 Photogrammetric Mapping, EM-1110-1-1002 Survey Markers and Monumentation, EM-1110-1-1003 NAVSTAR Global Positioning System Surveying, EM-1110-1-1004 Deformation Monitoring and Control Surveying, EM-1110-1-1005 Topographic Surveying, EM-1110-2-1003 Hydrographic Surveying, EM-1110-1-2909 Geospatial Data and System, Tri-Services A/E/C CADD Standards, Tri-Services Spatial Data Standards, Related Spatial Data Products and Chapter 177, Chapter 472, and Chapter 61G17 of the Minimum Technical Standards set by the Florida Board of Professional Surveyors and Mappers.

2f1. Digital Geospatial Metadata. Metadata are "data about data". They describe the content, identification, data quality, spatial data organization, spatial reference, entity and attribute information, distribution, metadata reference, and other characteristics of data. Each survey project shall have metadata submitted with the final data submittal.

2f2. Furnish a digital file using CORPSMET 95 (Metadata Software) with the appropriate data included. Point of contact in survey section Mr. Bill Mihalik at 904-232-1462.

2g. All digital data shall be submitted on CD ROM's.

2h. EXISTING DATA. The Contractor shall be furnished DTM files and existing sheet layout of previous monitoring survey. The Contractor shall utilize this information to perform survey comparisons. These comparisons are quality assurance measures for the Contractor to the correctness of his data.

3. FIELD SURVEY EFFORT. Hydrographic and topographic monitoring data shall be collected for CCAFS-29, CCAFS-30, CCAFS-33 through CCAFS-42, BC-5 through BC-14, and DEP R-0 through DEP R-18 including DEP R-1-AA and DEP R-1-A. The area is shown on Enclosure 1, USGS quads. Enclosure 2 is the control monument descriptions and profile line azimuth. Enclosure 3 is the technical requirements for the surveys.

3a. CONTROL. The Horizontal datum shall be NAD 1927 and the vertical datum shall be NGVD 29 MLW. All control surveys shall be Third-Order, Class II accuracy and shall comply with the Engineering Manuals listed above.

3a1. The basic control network shall be accomplished using precise differential carrier-phase Global Positioning System (GPS) and Differential GPS baseline vector observations.

3a2. Network design, station and baseline occupation requirements, for static and kinematic surveys, satellite observation time per baseline, baseline redundancies, and connection requirements to existing networks, shall follow the criteria given in the above said engineering manual. A field observation log shall be completed at each setup in the field.

3a3. GPS derived elevation data shall be supplied in reference to the above said datum. Existing benchmark data and stations shall be used in tandem in a minimally constrained adjustment program to model the geoid. All supporting data used in vertical adjustment shall be submitted to Survey Section. The GPS plan shall be submitted and approved by Mr. Lonnie Zurfluh prior to commencing work.

3a4. Establish or recover 1 horizontal and vertical control monument for each profile line. The established position for each monument recover shall be utilized and new positions shall be established for any new monuments established. The GPS network (if required) shall commence from the control shown on Enclosure 2. All established or recovered control shall be fully described and entered in a FIELD BOOK, in accordance with the Technical Requirements of this contract. All control surveys shall be Third-Order, Class II accuracy. The Contractor shall submit the field data and abstracts for the control networks to Survey Section for computation before commencing the mapping. The monument designations shall be furnished as requested.

3a5. All horizontal and vertical control (double run forward and back) established shall be a closed traverse or level loop no spur lines, with Third-Order accuracy. All horizontal and vertical control along with baseline layouts, sketches, and pertinent data shall be entered in field books.

3a6. All monuments, survey markers, etc., recovered shall be noted on the copies of control descriptions. Control points established or recovered with no description or out-of-date (5 Years old) description shall be described with sketches for future recovery use.

3a7. All original field notes shall be kept in standard pocket size field books and shall become the property of the Government. The first four pages of the field books shall be reserved for indexing and the binding outside edge shall be free of all marking. All control surveys shall be Third-Order, Class II accuracy.

3b. BEACH PROFILES. Recover or establish one (1) horizontal and vertical control monument for Sand Bypass System CCAFS-29, CCAFS-30, CCAFS-33, CCAFS-34, CCAFS-35, CCAFS-36, CCAFS-37, CCAFS-38, CCAFS-38A, CCAFS-39, CCAFS-39A, CCAFS-40, CCAFS-40A, CCAFS-41, CCAFS-41A, CCAFS-42, BC-5, BC-6, BC-7, BC-8, BC-9, BC-10, BC-11, BC-12, BC-13, BC-14, DEP R-0, R-1T RESET, R-1-AA, R-1A, R-2, R-3, T-4 RESET, R-5, R-6-T RESET, R-7-T RESET, R-8 RESET, R-9, T-10, R-11, R-12, R-13, R-14, R-15-T, R-16, R-17 and R-18. Utilize the coordinates, elevations, and azimuths shown on Enclosure 2.

3b1. Certification of original and all reset DEP monuments shall be conducted prior to any survey data being collected. In the event several benchmarks are discovered for one specific monument, the enclosed excel worksheet highlights the benchmark to be conserved (all others should be destroyed). This work shall be accomplished and completed prior to collecting any survey data in Jun/Jul 99.

3b2. All profile lines shall extend 150 feet landward (or to the limits of the beach), from the established DNR monument or until a building, road, wall, protected vegetation, water, etc. is encountered (note features along profiles and write descriptor in field book for all land features located west of and including the monuments at point collected on land side). The profile lines shall extend seaward from the monument a distance of no less than 3,000 feet.

3b3. Obtain data points (X, Y, Z) on 10-foot ranges (land), all breaks in grade greater than 1 foot vertically, vegetation line, tops and toes of dunes, seawalls, or other manmade features along the profile line. Soundings shall be identified at 12.5' ranges along the profile.

3c. TIDE STAFF. Establish an on-site tide staff referenced to mean low water, which is 1.90' below NGVD of 1929. Maintain a 0.1' frequency reading log during the water portion of the survey. Monument "SOUTHPORT" shall be utilized for the tide staff.

3d. BREAKLINE. Breaklines shall be located for all natural or man-made features as needed. The breaklines shall be located with X, Y, and Z and identified.

3e. SOUNDING POLE / 6" DISK: A sounding pole or sounding rod with a 6 inch diameter disk attached to the bottom shall be used.

3f. DATA COLLECTION (RTK or TOTAL STATION). Data collection will be allowed for data points only, showing all instrument positions, calibration, backsights, and closing readings in the field book.

4. DATA PROCESSING. The Contractor shall make the necessary computations to verify the correctness of all measurements and apply the proper theory of location in accordance with the law or precedent and publish the results of the survey. The Contractor shall submit advance copies of the horizontal control so that USACE can compute the final positions before commencing mapping. Compute and tabulate the horizontal and vertical positions on all work performed. Review and edit all field data for discrepancies before plotting the final drawings.

4a. Furnish X, Y, Z and descriptor ASCII file for each profile line and one X, Y, Z, and descriptor ASCII file with all data included for each area.

4b. Furnish a DEP format ASCII file for each profile line.

5. CADD. The survey data shall be translated or digital capture into Intergraph IGDS 3D design files according to the specifications furnished. The survey data shall be provided in Intergraph MicroStation Version 5.0 or higher as shown in the letter dated 30 September 1992. The neat mapping area on all sheets (cover and plan) shall be 30-inches by 25-inches.

5a. GLOBAL ORIGIN. The IGDS 3-D design file shall be prepared with a global origin of 0, 0, 2147483.65, Design file master units: FT., Sub units: 1,000, and positional units: 1. The file name shall be the survey number prefixed to an "A" i.e., a267S1.DGN. All reference file names shall commence with the a267 also.

5b. DIGITAL TERRAIN MODEL (DTM) DATA. The Contractor shall develop and deliver a surface model of the area using Intergraph compatible Digital Terrain Modeling software and the model file shall have the .dtm extension. The digital terrain model shall be developed from the collected data. Breaklines should include ridges, drainage, road edges, surface water boundaries, and other linear features implying a change in slope. The surface model shall be of adequate density and quality to produce a one-foot contour interval derived from the original DTM (Digital Terrain Model) file. The contour data shall be incorporated as a reference file into the final data set. All data used to develop the DTM's shall be delivered in Intergraph 3-D design files.

EM 1110-1-1003
1 Jul 03

5b1. CONTOURS. The contours shall be developed in the digital terrain model (DTM). The contours shall be provided in one or more master DGN files, attached as a reference file to all sheet files utilizing the clip bounds methods. Each contour shall be drawn sharp and clear as a continuous solid line, dashed contours are not acceptable. Every index contour shall be accentuated as a heavier line than the intermediate and shall be annotated according to its actual elevation above MLW. Whenever index contours are closer than one-quarter (1/4) inch, and the ground slope is uniform, the intermediate shall be omitted. Labeling or numbering of contours shall be placed on top of the contour line, so that the elevation is readily discernible, do not break contours. Labeling of intermediate contours may be required in areas of low relief.

5c. MODEL DGN FILES (SCALE 1:1).

5c1. The beach profile upland (land) data shall be provided in one or more master DGN file attached as a reference file to all sheet files utilizing the clip bounds methods.

5c2. The beach profile offshore (water) data shall be provided in one or more master DGN file attached as a reference file to all sheet files utilizing the clip bounds methods.

5c3. The control data shall be provided in one or more master DGN file attached as a reference file to all sheet files utilizing the clip bounds methods.

5c4. The contours shall be provided in one or more master DGN file attached as a reference file to all sheet files utilizing the clip bounds methods.

5c5. The breaklines shall be provided in one or more master DGN file attached as a reference file to all sheet files utilizing the clip bounds methods.

5d. COVER AND CONTROL SHEET. The first sheet shall be a cover sheet showing the control sketch, survey control tabulation, sheet layout or index, legend, project location map, survey notes, north arrow, graphic scale, grid ticks, and large signature block. Tabulate, plot, and list the horizontal control used for the survey on the final drawings.

5e. PLAN SHEETS. The plan sheets shall be prepared to a scale of 1"=100', in the Corps of Engineers format (reference letter and instruction dated September 30, 1992) showing notes, title block, grid, north arrow, graphic scale, legend, sheet index, and D. O. File Number. Sheets shall be oriented with north to the top. The extreme right 7 inches of the sheet shall be left blank for notes, legends, etc. The second sheet and all sheets following shall be a continuation sheet and shall have a minimum of two notes, note 1: See Drawing number 1 for notes, note 2: Refer to Survey No. 99-267. The existing sheet layout shall be furnished.

5d. SECTION VIEWS. The sections shall be extracted and displayed from the digital terrain model (DTM OR TTN) utilizing INROADS OR INXPRESS. The sections shall be generated or extracted along the same azimuth as the section was collected in the field. The sections shall be displayed at a 10 to 1 vertical exaggeration. The planimetric lines (alignment of extraction), alignment, stations, and cross sections shall be displayed in one DGN file (NO PLOTS).

6. MAP CONTENT.

6a. COORDINATE GRID (NAD 27). Grid ticks (English) of the applicable State Plane Coordinate System shall be properly annotated at the top, bottom and both sides of each sheet. Spacing of the grid ticks shall be five (5) inches apart.

6b. CONTROL. All horizontal and vertical ground control monuments shall be shown on the maps in plan and tabulated.

6c. TOPOGRAPHY. The map shall contain all representable and specified topographic features that are visible or identifiable.

6d. SPOT ELEVATIONS. Spot elevations shall be shown on the maps in proper position.

6e. MAP EDIT. All names, labels, notes, and map information shall be checked for accuracy and completeness.

6f. SHEET INDEX AND LEGEND. On plan drawings a small-scale sheet index shall be shown on each sheet of the series; highlighting the sheets in the standard manner. Planimetric and topographic feature legends shall be shown on each sheet. Contractor logo shall be shown on each drawing.

6g. MAP ACCURACY. All mapping shall conform to the national map accuracy standards except that no dashed contour line will be accepted.

7. OFFICE REVIEW AND COMPUTATIONS. The Contractor shall make the necessary computations to verify the correctness of all measurements and apply the proper theory of location in accordance with the law or precedent and publish the results of the survey. The contractor shall submit the original field notes and horizontal and vertical abstract (computation abstract) to Survey Section for final computation before mapping commences.

8. DELIVERIES. On completion, all data required shall be delivered or mailed to Design Branch, Survey Section at the address shown in contract, and shall be accompanied by a properly numbered, dated and signed letter or shipping form, in duplicate, listing the materials being transmitted. All costs of deliveries shall be borne by the Contractor. Items to be delivered include, but are not limited to the following:

- 8a. GPS network plan, (before GPS work commences).
- 8b. GPS raw data along with field observation log sheets filled out in field with all information and sketches.
- 8c. Computation files with Horizontal and Vertical abstracts along.
- 8d. Horizontal and Vertical Field Books.
- 8e. Furnish X, Y, Z, and descriptor ASCII file for each beach profile and one merged with all beach profile data.
- 8f. Furnish DEP format file for each profile line.
- 8g. DTM File.
- 8h. Master DGN files.
- 8i. DGN sheet files at 1"=100.
- 8j. Furnish a digital file using CORPSMET 95 (Metadata Software) with the appropriate data included.
- 8k. Excel file with Monument ID, X, Y, Z, and Azimuth of profile line.

AUTHOR EN-DT JERRY T. BURCHFIELD

APPROVED BY _____
ED HODGENS (EN-HC)

SAMPLE RECORD OF NEGOTIATIONS

CESAJ-EN-DT (1110-2-1150a) 24 Jun 99

MEMORANDUM FOR: CONTRACT FILES

SUBJECT: Negotiations Memorandum: Contract No. DACW17-98-D-0004, Brevard County, Sand Bypass System Post Construction One-Year Monitoring Beach Erosion Survey, Canaveral Harbor, Florida (Survey 99-267)

1. References.

- a. Letter RFP CESAJ-EN-DT, 9 Jun 99, subject: Contract No. DACW17-98-D-0004.
 - b. Government Survey Estimate, 3 Jun 99, prepared by Mr. Burchfield (CESAJ-EN-DT), in the amount of \$60,831.00 and approved by Mr. Walter Clay Sanders, Assistant Chief, Engineering Division, 9 Jun 99.
 - c. Contractor's (Sea System, Inc - SEA) initial letter of proposal, 23 Jun 99, in the amount of \$76,135.00.
 - d. Contractor's (Sea System, Inc - SEA) revised letter of proposal, 24 Jun 99, in the amount of \$59,775.00.
2. The Contractor's initial proposal of \$76,135.00 is above the Government Estimate of \$60, 831.00 by \$15,304.00. The Contractor's revised proposal of \$59,775.00 is below the Government Estimate of \$60,831.00 by \$1,056.00.
3. On 24 Jun 99, a line-by-line comparison of the estimate and proposal was performed (per References 1b and 1c) as follows:

<u>CONTRACTOR'S PROPOSAL (23 JUN 99)</u>			
	<u>Item</u>	<u>Quantity</u>	<u>Amount</u>
2002	5-Man Hydro Crew	38.0 CD @ \$1,404.00	\$ 53,352.00
2003	Survey Helper (Deduct)	38.0 MD @ 144.00	- 5,472.00
2004a	Per Diem	152.0 MD @ 65.00	9,880.00
2005	Project Manager	5.0 MD @ 436.00	2,180.00
2006a	Per Diem (PM)	5.0 MD @ 92.00	460.00
2007	CADD Operator	15.0 MD @ 333.00	4,995.00
2008	Survey Computer	20.0 MD @ 318.00	6,360.00
2011	Establish Monuments	4.0 EA @ 25.00	100.00
2015a	GPS First Unit	26.0 DY @ 130.00	3,380.00
2015b	Second Unit	10.0 DY @ 90.00	900.00
	Total-----		\$ 76,135.00

<u>GOVERNMENT ESTIMATE (3 JUN 99)</u>			
	<u>Item</u>	<u>Quantity</u>	<u>Amount</u>
2002	5-Man Hydro Crew	30.0 CD @ \$1,404.00	\$ 42,120.00
2003	Survey Helper (Deduct)	30.0 MD @ 144.00	- 4,320.00
2004a	Per Diem	120.0 MD @ 65.00	7,800.00
2005	Project Manager	7.0 MD @ 436.00	3,052.00
2006a	Per Diem (PM)	7.0 MD @ 92.00	644.00
2007	CADD Operator	27.0 MD @ 333.00	8,991.00
2008	Survey Computer	8.0 MD @ 318.00	2,544.00
	Total-----		\$ 60,831.00

4. Line-by-line discussions with the Contractor took place on 24 Jun 99 between Jerry T. Burchfield (CESAJ-EN-DT) and Stan Copeland (SEA). The Request for Proposal (RFP), the technical requirements (TR), work effort, line items, and time period were reviewed with the Contractor.

4a. Line item's 2005, 2006a, and 2007 were the same or below the Government Estimate. Line item's 2002, 2003, 2004a, 2008, 2011, 2015a, and 2015b of the Contractor's proposal is above the Government Estimate. We agreed to use the existing positions of the control monuments therefore line item's 2011, 2015a, and 2015b of the

Contractor's proposal are not required and line item's 2002, and 2003 were reduced. Line item 2008 was reduced and line item 2007 was increased base on the computation and CADD requirements.

4b. During discussion with the Contractor, it was discovered that line item's 2002 requires 30 days, 2003 requires 30 days (Deduct), 2004a requires 120 days, 2005 requires 5 days, 2006a requires 5 days, 2007 requires 27 days, and 2008 requires 8 days.

5. The Contractor and the Government agreed to a completion date of 60 days after the Notice To Proceed is signed by the Contracting Officer and that these negotiations are subject to approval of the Contracting Officer and do not authorize the Contractor to commence work. The Contracting Officer will issue the Notice to Proceed.

6. The Contractor's Proposed cost of \$59,775.00 is considered fair and reasonable based on time and effort reasonably expected of a prudent contractor or Government forces performing the same services, and is recommended for acceptance by the Contracting Officer.

7. Sea System, Inc was selected for this Task Order based on an equitable distribution of work among our AE Contractors.

PREPARED BY _____ DATE
JERRY T. BURCHFIELD/CESAJ-EN-DT

REVIEWED BY _____ DATE
D. TONEY LANIER
CHIEF, SPECIFICATIONS SECTION

APPROVAL RECOMMENDED _____ DATE
WALTER CLAY SANDERS, P.E.
ASSISTANT CHIEF, ENGINEERING DIVISION

APPROVED BY _____ DATE

Appendix A References

A-1. Required References

ER 1110-1-8156

Policies, Guidance, and Requirements for Geospatial Data and Systems

ER 1110-2-1150

Engineering and Design for Civil Works Projects

EP 715-1-7

Architect-Engineer Contracting

EM 1110-1-1002

Survey Markers and Monumentation

EM 1110-1-1000

Photogrammetric Mapping

EM 1110-1-1004

Geodetic and Control Surveying

EM 1110-1-2909

Geospatial Data and Systems

EM 1110-2-1003

Hydrographic Surveying

EM 1110-2-1009

Structural Deformation Surveying

NOTE: The above Corps of Engineers publications may be downloaded at
<http://www.usace.army.mil/inet/usace-docs/>.

A-2. Related References

DoD 1996

"NAVSTAR GPS User Equipment Introduction," DoD Joint Program Office, September 1996

DoD 2001

"Global Positioning System Standard Positioning Service Performance Standard," October 2001, Asst Secretary for Command, Control, Communications, and Intelligence

Executive Order 12906

Coordinating Geographic Data Acquisition and Access: The National Spatial Data Infrastructure (NSDI)

FGCC 1988

"Geometric Geodetic Accuracy Standards and Specifications for Using GPS Relative Positioning Techniques," Version 5.0 11 May 1988, (Reprinted with Corrections: 1 Aug 1989), Federal Geodetic Control Committee, 1988. Note: the FGCC is now the Federal Geodetic Control Subcommittee (FGCS) under the Federal Geographic Data Committee (FGDC)

FGDC 1998a

"Geospatial Positioning Accuracy Standards, PART 1: Reporting Methodology," Federal Geographic Data Committee, FGDC-STD-007.1-1998

FGDC 1998b

"Geospatial Positioning Accuracy Standards, PART 2: Standards for Geodetic Networks," Federal Geographic Data Committee, FGDC-STD-007.2-1998

FGDC 1998c

"Geospatial Positioning Accuracy Standards, PART 3: National Standard for Spatial Data Accuracy," Federal Geographic Data Committee, FGDC-STD-007.3-1998

FGDC 1998d

"Content Standard for Digital Geospatial Metadata (Version 2.0)," Federal Geographic Data Committee, FGDC-STD-001-1998

FGDC 2002

"Geospatial Positioning Accuracy Standards, PART 4: Standards for Architecture, Engineering, Construction (A/E/C) and Facility Management," Federal Geographic Data Committee, FGDC-STD-007.4-2002

FRP 2001

"2001 Federal Radionavigation Plan," and "2001 Federal Radionavigation Systems," Department of Defense and Department of Transportation, 2001.

Kaplin 1996

Kaplin, E. D., "Understanding GPS Principles and Applications," 1996, Artech House, Inc.

Leick 1995

Leick, A., 1995, "GPS Satellite Surveying," (Second Edition) John Wiley & Sons.

Mikhail 1976

Mikhail, Edward M., and Ackermann, Friedrich E. 1976. *Observations and Least-Squares*, IEP Series in Civil Engineering, New York.

NGS 2000

"PAGE-NT User's Manual," Version 2000.09.07, National Geodetic Survey, September 2000.

NOAA 1994

"Input Formats and Specifications of the National Geodetic Survey Data Base," NOAA, National Geodetic Survey, September 1994.

NOAA 1997

NOAA Technical Memorandum NOS NGS-58, Zilkoski, D.B., D'Onofrio, J. D., and Frankes, S. J. (Nov 1997) "Guidelines for Establishing GPS-Derived Ellipsoid Heights (Standards: 2 cm and 5 cm)," Version 4.1.3. Silver Spring, Maryland.

Public Law 92-582

Public Law 92-582, (86 STAT. 1278), "Public Buildings--Selection of Architects and Engineers"

Remondi 1985

Remondi, B. W. 1985. "Global Positioning System Carrier Phase: Description and Use."

Snay & Soler 1999

Snay, R.A. & Soler, T., "Modern Terrestrial Reference Systems, " Professional Surveyor Magazine, 1999-2000

Trimble 2000a

Postprocessed Surveying Workbook, Revision A, Number 33143-30, Trimble Navigation LTD, May 2000

Trimble 2000b

Real-Time Surveying Workbook, Revision A, Number 33142-30, Trimble Navigation LTD, January 2000

Trimble 2000c

TRIMMARK 3 Radio Modem User Guide, Revision A, Trimble Navigation LTD, December 2000

Trimble 2001a

Trimble Survey Controller Reference Manual/Field Guide, Version 7.7 Revision A, Trimble Navigation LTD, January 2001

Trimble 2001b

5700 GPS Receiver User Guide, Version 1.0, Revision A, Trimble Navigation LTD, January 2001

Trimble 2001c

Trimble Geomatics Office--Network Adjustment Software User Guide, Version 1.5, Revision A, Number 39933-10-ENG, Trimble Navigation LTD, January 2001.

Trimble 2001d

Trimble Geomatics Office--WAVE Baseline Processing Software User Guide, Version 1.5, Revision A, Number 39685-10-ENG, Trimble Navigation LTD, January 2001.

Trimble 2001e

GPS Pathfinder Systems Receiver Manual, Version 1.00, Revision B, Trimble Navigation LTD, April 2001.

Trimble 2001f

GeoExplorer 3 Operation Guide, Revision A, Trimble Navigation LTD, March 2001

Trimble 2002

Trimble Geomatics Office User Guide, Revision A, Number 46741-20-ENG, Trimble Navigation LTD, April 2002

EM 1110-1-1003
1 Jul 03

Trimble 2002a

GPS Pathfinder Office, Version 2.90, Trimble Navigation LTD, January 2002

USFS/BLM 2001

"Standards and Guidelines for Cadastral Surveys using Global Positioning System Methods," Version 1.0, 9 May 2001, USDA (Forest Service) and USDI (Bureau of Land Management)

Van Sickle 2001

Jan Van Sickle, 2001. "GPS for Land Surveyors," Second Edition, Ann Arbor Press.

Waypoint 2001

"GrafNav/GrafNet, GrafNav Lite, GrafMov Operating Manual," Version 6.03, Waypoint Consulting, Inc, August 2001.

A-3. Related Publications (Not Referenced)

Ackroyd and Lorimer 1990

Ackroyd, N. and Lorimer, R., 1990, "Global Navigation--A GPS User's Guide," Lloyd's of London Press Ltd.

American Society for Photogrammetry and Remote Sensing 1989

American Society for Photogrammetry and Remote Sensing. 1989. "ASPRS Accuracy Standards for Large-Scale Maps," *Photogrammetric Engineering and Remote Sensing*, pp 1068 and 1070.

Bossler and Challstrom 1985

Bossler, J. D., and Challstrom, C. W. 1985. "GPS Instrumentation and Federal Policy."

Bureau of the Budget 1947

Bureau of the Budget. 1947 (17 June). "United States National Map Accuracy Standards," US Bureau of the Budget.

Burkhard, Richard K., et al. 1983

Geodesy for the Layman," Defense Mapping Agency (DMA).

Canadian GPS Associates 1987

Guide to GPS Positioning, Fredericton, New Brunswick, Canada.

Department of Defense 1987

"Department of Defense World Geodetic System 1984 - Its Definition and Relationships with Local Geodetic Systems." 1987. DMA Technical Report 8350.2.

FGCS 1980

Federal Geodetic Control Subcommittee 1980

"Input Formats and Specifications of the National Geodetic Data Base" (also termed the "Bluebook")

Federal Geodetic Control Committee 1984

Federal Geodetic Control Committee. 1984. "Standards and Specifications for Geodetic Control Networks," Rockville, MD.

Global Positioning System Subcommittee 1989

Global Positioning System Subcommittee. 1989 (January-February). *GPS Bulletin*, Commission VIII, International Association of Geodesy/International Union of Geodesy and Geophysics. Vol 2, No. 1.

Goad 1985

Goad, C. C. 1985. "Precise Relative Position Determination Using Global Positioning System Carrier Phase Measurements in a Nondifference Mode."

Hein 1985

Hein, G. W. 1985. "Orthometric Height Determination Using GPS Observations and the Integrated Adjustment Model," NOAA Technical Report NOS 110 NGS-32, National Oceanic and Atmospheric Administration.

EM 1110-1-1003
1 Jul 03

Hothem and Fronczek 1983

Hothem, L. D. and Fronczek, C. J. 1983. "Report on Test and Demonstration of Macrometer Model V-1000 Interferometric Surveyor," Federal Geodetic Control Committee.

Hothem and Williams 1985

Hothem, L. D., and Williams, G. E. 1985. "Factors to be Considered in Development of Specifications for Geodetic Surveys Using Relative Positioning GPS Techniques."

Hothem, Goad, and Remondi 1984

Hothem, L. D., Goad, C. C., and Remondi, B. W. 1984. "GPS Satellite Surveying - Practical Aspects."

Kass and Dulaney 1986

Kass, W. G., and Dulaney, R. 1986. "Procedures for Processing GPS Phase Observations at the National Geodetic Survey."

Lucas and Mader 1988

Lucas, J. R., and Mader, G. L. 1988. "Recent Advances in Kinematic GPS Photogrammetry."

Mader 1986

Mader, G. L. 1986. "Decimeter Precision Aircraft Positioning using GPS Carrier Phase."

Mader and Abell 1985

Mader, G. L., and Abell, M. D. 1985. "A Comparison between Global Positioning System and Very Long Baseline Interferometry Surveys in Alaska and Canada."

Milbert 1985a

Milbert, D. G. 1985a. "Application of the Variance Factor Test to a Global Positioning System Survey."

Milbert 1985b

Milbert, D. G. 1985b. "Preliminary Analysis of an Operational Global Position System Control Survey."

Milbert 1988

Milbert, D. G. 1988. "Network Adjustment of Correlated Coordinate Difference Observations."

Milbert 1996

Milbert, D.G. and Smith D.A. (1996). Converting GPS Height into NAVD 88 Elevation with the Geoid 96 Geoid Height Model. National Geodetic Survey, Silver Spring, Maryland.

Minke 1988

Minke, D. H. 1988. "Kinematic GPS Land Survey--Description of Operational Test and Results."

National Geodetic Information Center 1989

National Geodetic Information Center. 1989 (revised). "Documents Available on GPS," Information Flyer 86-1, National Oceanic and Atmospheric Administration.

National Geodetic Survey 1986

National Geodetic Survey. 1986. "Geodetic Glossary," 242 pp.

National Geodetic Survey 1988

National Geodetic Survey. 1988. "Guidelines for Submitting GPS Relative Positioning Data to the National Geodetic Survey," Rockville, MD.

National Oceanic and Atmospheric Administration 1988

National Oceanic and Atmospheric Administration. 1988. "National Geodetic Survey State Plane Coordinate Manual NAD 1983."

Remondi 1984

Remondi, B. W. 1984. "Using the Global Positioning System (GPS) Phase Observable for Relative Geodesy: Modeling, Processing, and Results," Ph.D dissertation, University of Texas.

Remondi 1985b

Remondi, B. W. 1985b. "Modeling the GPS Carrier Phase for Geodetic Applications."

Remondi 1985c

Remondi, B. W. 1985c. "Performing Centimeter-Level Surveys in Seconds with GPS Carrier Phase: Initial Results," NOAA Technical Memorandum NOS NGS-43, National Oceanic and Atmospheric Administration.

Remondi 1986

Remondi, B. W. 1986. "Distribution of Global Positioning System Ephemerides by the National Geodetic Survey," ACSM spring meeting, March 1986.

Remondi 1991

Remondi, B. W. 1991. "Kinematic GPS Results Without Static Initialization, NOAA Technical Memorandum NOS NGS-55", May 1991.

Remondi, 1992a

Remondi, B. W. 1992a. "Real-Time Centimeter-Accuracy Without Static Initialization", Sixth Internal Geodetic Symposium on Satellite Positioning, Columbus, Ohio.

Remondi, 1992b

Remondi, B. W. 1992b. "Real-Time Centimeter-Accuracy While in Motion (Warm Start Versus Cold Start), 5th International Technical Meeting ION GPS-92, Albuquerque, New Mexico.

Remondi and Hofmann-Wellenhof 1989

Remondi, B. W., and Hofmann-Wellenhof, B. 1989. "Accuracy of Global Positioning System Broadcast Orbits from Relative Surveys."

Snay 1986

Snay R. A. 1986. "Network Design Strategies Applicable to GPS Surveys using Three or Four Receivers."

Soler and Hothem 1988

Soler, T., and Hothem, L. 1988. "Coordinate Systems used in Geodesy - Basic Definitions and Concepts," *Journal on Surveying and Engineering, American Society of Civil Engineers.*

Soler, Hothem, and Fury 1986

Soler, T., Hothem, L. D., and Fury, R. J. 1986. "Precise Geodetic Surveying with Code and Carrier Phase Tracking GPS Receivers."

Stenn 1989

Stenn, James E. 1989. "The State Plane Coordinate System of 1983," NOAA Manual NOS NGS 5, National Oceanic and Atmospheric Administration.

Strange 1985

Strange, W. E. 1985. "High-Precision Three-Dimensional Differential Positioning Using GPS."

Zilkoski 1990a

Zilkoski, David B. 1990a. "Establishing Vertical Control Using GPS Satellite Surveys," *Proceedings of the 19th International Federation of Surveying Congress*, National Geodetic Survey.

Zilkoski 1990b

Zilkoski, David B. 1990b. "Minimum Steps Required when Estimating GPS-Derived Orthometric Heights," *Proceedings of the Fall GIS/LIS 1990 Convention*.

Zilkoski and Hothem 1989

Zilkoski, David B., and Hothem, Larry D. 1989. "GPS Satellite Surveys and Vertical Control," *Journal of Surveying Engineering*.

Zilkoski 1992

Zilkoski, D.B., Richards, J.H., and Young, G.M. (1992). Special Report: Results of the General Adjustment of the North American Vertical Datum of 1988, Silver Spring, Maryland.

Appendix B Abbreviations and Acronyms

1-D.....	One dimensional
2-D.....	Two-dimensional
3-D.....	Three-dimensional
2DRMS	Two (standard) deviations root mean square
A-E	Architect-Engineer
A/S.....	Anti-Spoofing
ABGPS.....	Airborne GPS
ACSM	American Congress on Surveying and Mapping
AFARS.....	Army Federal Acquisition Regulation Supplement
ALTA.....	American Land Title Association
APC.....	Antenna phase center
ARP	Antenna reference point
ASCE	American Society of Civil Engineers
ASPRS	American Society of Photogrammetry and Remote Sensing
BIH.....	Bureau International Heure
C/A-code	Coarse Acquisition Code
CADD.....	Computer Aided Design and Drafting
CDC.....	Consecutive Doppler Counts
CDMS	Continuous Deformation Monitoring System
CEP.....	Circular error probable
CID	Continuously Integrated Doppler
cm.....	centimeter
CONUS.....	Continental United States
CORS.....	Continuously Operating Reference Station
CTP.....	Conventional Terrestrial Pole
CW.....	Civil Works
DFARS.....	Defense Federal Acquisition Regulation Supplement
DGPS	Differential GPS
DMA	Defense Mapping Agency (now NIMA)
DOP	Dilution of Position
DoD	Department of Defense
DoT.....	Department of Transportation
E&D.....	Engineering and design
ECC	estimated construction cost
ECDIS.....	Electronic Charting and Information System
ECEF.....	Earth centered earth fixed
EDM.....	electronic distance measurement
EFARS.....	Engineer Federal Acquisition Regulation Supplement
EM.....	Engineer Manual
EP	Engineer Pamphlet
ER.....	Engineer Regulation
ERDC.....	Engineer Research and Development Center
FAA.....	Federal Aviation Administration
FAR	Federal Acquisition Regulation
FFP	Firm fixed-price
FGCC.....	Federal Geodetic Control Committee
FGCS.....	Federal Geodetic Control Subcommittee
FGDC.....	Federal Geographic Data Committee

FOC	Full Operational Capability
FRP	Federal Radionavigation Plan
FRS	Federal Radionavigation Systems
ft	foot or feet
FY	Fiscal Year
G&A	General & Administrative (overhead)
GDOP	Geometric dilution of precision
GIS.....	Geographic Information System
GLONASS.....	Global Orbiting Satellite Navigation System
GNSS	Global Satellite Navigation System
GPS.....	Global Positioning System
GRS 80.....	Geodetic Reference System of 1980
HARNs.....	High Accuracy Reference Networks
HDOP	Horizontal dilution of precision
HI.....	Height of Instrument
HPGN	High Precision Geodetic Network
HQSACE.....	Headquarters, US Army Corps of Engineers
IDC	Indefinite Delivery Contract
IERS.....	International Earth Rotation Service
IGE.....	Internal Government Estimate
IGLD 55	International Great Lakes Datum of 1955
IGLD 85	International Great Lakes Datum of 1985
IGS.....	International GPS Services
IID	Intermittently Integrated Doppler
IMU	Inertial Measurement Unit
IOC	Initial Operating Capability
IRON	Inter Range Operation Number
ITRF.....	International Terrestrial Reference Frame
JPO	Joint Program Office
KO.....	Contracting Officer
LAAS.....	Local Area Augmentation System
LIDAR	Light Detection and Ranging
LMN	Local Notice to Mariners
m.....	meter
M-code	Military code
MHz.....	Megahertz
MSC.....	Major Subordinate Command
MSE.....	Mean square error
NAD 27	North American Datum of 1927
NAD 83	North American Datum of 1983
NANU.....	Notice: Advisory to Navigation Users
NASA	National Aeronautics and Space Administration
NATO	North Atlantic Treaty Organization
NAVCEN	Navigation Center (US Coast Guard)
NAVD 88	North American Vertical Datum of 1988
NGRS.....	National Geodetic Reference System
NGS	National Geodetic Survey
NGVD 29	National Geodetic Vertical Datum of 1929
NIMA.....	National Imagery and Mapping Agency
NIS.....	Navigation Information Service
NMEA.....	National Maritime Electronics Association

NOAA.....National Oceanic and Atmospheric Administration
NOS.....National Ocean Service
NOTAM.....Notice to Airmen
OCONUS.....Outside the Continental United States
OPUS.....On-Line Positioning User Service
OTF.....On-The-Fly
P-code.....Precise Code or Precision Code
PDOP.....Positional Dilution of Precision
PPS.....Precise Positioning Service
PRC.....Pseudorange correction
PRN.....Pseudo-Random Noise
PROSPECT.....Proponent Sponsored Engineer Corps Training
PVT.....Position-Velocity-Time
RINEX.....Receiver INdependent EXchange
RMS.....Root mean square
RTCM.....Radio Technical Commission for Maritime Services
RTK.....Real-Time Kinematic
S/A.....Selective availability
SCOUT.....Scripps Coordinate Update Tool
SIS.....Signal in space
SPCS.....State Plane Coordinate System
SPCS 27.....State Plane Coordinate System of 1927
SPCS 83.....State Plane Coordinate System of 1983
SPS.....Standard Positioning Service
TEC.....Topographic Engineering Center
U/M.....Unit of Measure
U/P.....Unit Price
UERE.....user equivalent range error
UHF.....Ultra high frequency
URE.....User range error
USACE.....US Army Corps of Engineers
USFS.....US Forest Service
USGS.....US Geological Survey
UT.....Universal Time
UTC.....Universal Time Coordinated
UTM.....Universal Transverse Mercator
VAC.....Volts alternating current
VDC.....Volts direct current
VDOP.....Vertical dilution of precision
VHF.....Very high frequency
VLBI.....Very long baseline interferometry
WAAS.....Wide Area Augmentation System (FAA)
WGS 84.....World Geodetic System of 1984

Appendix C

Contract Schedules for GPS Surveying Services

C-1. General

This Appendix contains a guide specification for use in preparing Architect-Engineer (A-E) contracts for professional surveying and mapping services where use of GPS methods is an integral part of the effort. These specifications are applicable to all A-E contracts used to support US Army Corps of Engineers (USACE) civil works and military construction design, construction, operations, maintenance, regulatory, and real estate activities. Since GPS is only a tool for supporting topographic, photogrammetric, or hydrographic surveys, an exclusive GPS survey contract would not normally be developed--i.e. these specifications would normally be incorporated into a traditional site plan mapping, photogrammetric mapping, or hydrographic surveying contract. This guide specification is intended for contracts, which are obtained using PL 92-582 (Brooks Act) qualification-based selection procedures.

C-2. Coverage

This guide specification contains the technical standards and/or references necessary to specify the more common static and kinematic differential (carrier phase tracking) GPS surveying methods that are currently (2002) in use. It is intended to support precise GPS control surveys performed for engineering and construction purposes. This guide supports the following types of differential GPS carrier phase surveying:

- Static Differential GPS Positioning
- Rapid Static Differential GPS Positioning
- Stop-and-Go Differential GPS Positioning
- Pseudo-kinematic Differential GPS Positioning
- Real-time On-the-Fly Differential GPS Positioning

Continuing developments of the above applications, along with the evolution of newer GPS survey techniques, mandates that these guide specifications be continuously evaluated by USACE Commands to insure they are technologically current.

C-3. Applicability

The following types of negotiated A-E contract actions are supported by these instructions:

- a.* Fixed-price surveying service contracts requiring GPS control.
- b.* Indefinite delivery contracts (IDC) for surveying services.
- c.* A multi-discipline surveying and mapping IDC contract in which GPS surveying services is a line item supporting other surveying, mapping, hydrography, and/or photogrammetry services.
- d.* A task order placed against an IDC contract.
- e.* Design and design-construct contracts that include incidental surveying and mapping services (including Title II services). Both fixed-price and IDC contracts are supported by these instructions.

C-4. Insertion of Technical Specifications

This Engineer Manual (EM 1110-1-1003, NAVSTAR GPS Surveying) shall be attached to and made part of any service contract for GPS surveying. References to this EM are made throughout this guide. These references will normally suffice for most USACE GPS survey specifications; however the guide also identifies areas where deviations from this manual must be considered.

a. Technical specifications for GPS surveying that are specific to the project, (including items such as the scope of work, procedural requirements, and accuracy requirements), will be placed under Section C of the SF 252 (Block 10). The prescribed format for developing the technical specifications is contained in this guide specification. Project-specific technical specifications shall not contain contract administrative functions -- these should be placed in more appropriate sections of the contract.

b. Standards and other specifications referenced in this guide specification should be checked for obsolescence and for dates and applicability of amendments and revisions issued subsequent to the publication of this specification. Maximum use should be made of existing EM's, Technical Manuals, and other recognized industry standards and specifications.

c. Throughout Section C of this guide, the specification writer must elect a contract performance method: (1) the government designs the GPS occupation/observing schedule, or (2) the contractor designs his performance method based on the criteria given in EM 1110-1-1003. Selection of the first method depends on the GPS survey expertise of the specification writer. This method also transfers much of the contract risk to the government. The second method is the preferred contract procedure.

C-5. Alternate Clauses/Provisions or Options

In order to distinguish between required clauses and optional clauses, required clauses are generally shown in capitol letters. Optional or selective clauses, such as would be used in a work order, are generally in lower case. In other instances, alternate clauses/provisions may be indicated by brackets "[]" and/or clauses preceded by a single asterisk "*". A single asterisk signifies that a clause or provision that is inapplicable to the particular section may be omitted, or that a choice of clauses may be made depending upon the technical surveying and mapping requirement. Clauses requiring insertion of descriptive material or additional project-specific specifications are indicated by either ellipsis or underlining in brackets (e.g., "[...]" "[____]"). In many instances, explanatory notes are included regarding the selection of alternate clauses or provisions.

C-6. Notes and Comments

General comments and instructions used in this guide are contained within asterisk blocks. These comments and instructions should be removed from the final contract.

C-7. Indefinite Delivery Contracts and Individual Task Order Assignments

Contract clauses that pertain to IDC contracts, or task orders thereto, are generally indicated by notes adjacent to the provision. These clauses should be deleted for fixed-price contracts. In general, sections dealing with IDC contracts are supplemented with appropriate comments pertaining to their use. Task orders against a basic IDC contract may be constructed using the format contained in Section C of this guide. This contract section is therefore applicable to any type of GPS service contracting action.

THE CONTRACT SCHEDULE

SECTION A

SOLICITATION/CONTRACT FORM

NOTE: Include here Standard Form 252

SF 252 -- (Block 5): PROJECT TITLE AND LOCATION

NOTE: The following sample titles represent projects under which static or kinematic GPS surveys are expected to play a significant role in developing basic project control, photo control, or local site plan mapping control. GPS surveys are used to support subsequent photogrammetric, plane table/total station site plan mapping, and construction layout operations.

{Fixed-price contract -- sample title}:

PROJECT CONTROL AND PHOTOGRAMMETRIC MAPPING CONTROL SURVEYS USING KINEMATIC DIFFERENTIAL NAVSTAR GPS IN SUPPORT OF SITE PLAN MAPPING FOR PRELIMINARY CONCEPT DESIGN OF FAMILY HOUSING COMPLEX ALPHA, FORT _____, ALABAMA.

PROJECT CONTROL REFERENCE SURVEYS USING STATIC DIFFERENTIAL NAVSTAR GPS POSITIONING FOR BOUNDARY DEMARCATION SURVEYS OF _____ [PROJECT], _____, CALIFORNIA.

{Indefinite Delivery Contract -- sample title}:

INDEFINITE DELIVERY CONTRACT FOR GEODETIC CONTROL, TOPOGRAPHIC MAPPING, AND RELATED SURVEYING SERVICES IN SUPPORT OF VARIOUS *[CIVIL WORKS] [MILITARY CONSTRUCTION] PROJECTS *[IN] [ASSIGNED TO] THE _____ DISTRICT.

SECTION B

SERVICES AND PRICES/COSTS

NOTE: The fee schedule for photogrammetric mapping and related survey services should be developed in conjunction with the preparation of the independent government estimate (IGE) along with the technical specifications. The unit of measure (U/M) used in a fee schedule for GPS mapping services is generally established on a daily rate basis (i.e. crew-day). U/Ms based on "per occupied point" or "per

baseline observation" are no longer recommended given the high variability in GPS equipment production.

The table below contains sample fee schedules that may be tailored for use on most GPS control surveying or mapping service contracts. The guide writer should select those line items applicable to the project, or for those projects envisioned over the course of an IDC contract. Other line items may be added which are unique to the project(s). If applicable, a separate fee schedule for contract option periods should be developed and negotiated during contract negotiations and included with the contract during initial award. Unit prices shall include direct and indirect overheads. Profit may or may not be included on IDC contract unit prices.

Procedures for estimating line item unit prices (U/P) are described in Chapter 12 of this EM. Determination of these estimated unit prices should conform to the detailed analysis method. The scope of each scheduled line item used in Section B must be thoroughly defined--either with the line item in Section B or at its corresponding reference in Section C of the contract. Many of the line item units of measure are comprised of costs from a variety of sources. These sources are combined in the IGE to arrive at the scheduled rate. Survey crew day rates normally include labor, travel, transportation, expendable materials, and numerous other items which are developed as part of the IGE. However, large items, such as travel, may be separately scheduled.

On IDC contracts, the specification writer should strive to avoid scheduling items, which have little probability of being required during the contract period. Since each line item must be separately estimated and negotiated, considerable government (and contractor) resources may be consumed in developing negotiated unit costs for unused items. Individual line items should not be included on an IDC contract unless there is a fair degree of assurance that these items will be required on a subsequent work order.

In addition, the specification writer should attempt to include only those line items that represent a major cost activity/phase in performing GPS surveying. Cost estimating emphasis and resources should be placed on major cost items, such as field crew labor. Avoid cluttering the schedule with small and relatively insignificant (to the overall project cost) supply and material items; again, minimizing the administrative costs of estimating and negotiating these items. These should be included as part of a major line item or be contained in the firm's overhead. Examples of normal supply items that the guide user should avoid scheduling are field survey books or bundles of 2"x2" survey stakes. These items would, however, be compensated for in the IGE. Care must be taken (in developing these schedules with the IGE) to preclude against duplication of costs between line items or overheads. Specific personnel and equipment requirements should be identified and itemized in applicable contract sections. This is particularly important when breaking out GPS receiver costs. The guide user (and cost estimator) must have a good working knowledge of GPS field surveying, baseline reduction, and data adjustment processes to properly allocate time and costs.

The following Section B outline may be tailored for either A-E fixed-price or A-E IDC contracts. For fixed-price contracts, the estimated quantities are available from the government estimate. For IDC contracts, a unit quantity for each line item would be negotiated and included in the basic contract. Daily units of measure (U/M) may be modified to hourly or other nominal units if needed. Lump sum or areal U/M (e.g., per baseline observation) may be developed for some of the services, although this is not recommended. The item numbers shown are for reference in this guide only -- they would be renumbered in the final contract. A sample of a completed "Schedule B" is shown in Chapter 12.

SERVICES AND PRICES/COSTS

ITEM	DESCRIPTION	QUAN	U/M	U/P	AMOUNT
0001	Registered/Licensed Land Surveyor-Office	[1]	Day		
0002	Registered/Licensed Land Surveyor-Field	[1]	Day		
0003	Civil Engineering Technician -- Field Party Supervisor (Multiple Crews)	[1]	Day		
0004	Engineering Technician (Draftsman)-Office	[1]	Day		
0005	Supervisory Survey Technician (Field)	[1]	Day		
0006	Surveying Technician -- GPS Instrumentman/Recorder	[1]	Day		
0007	Surveying Aid -- Rodman/Chainman {Conventional surveys}	[1]	Day		
0008	[Two][Three][Four][___]- Man [Static] [Kinematic] GPS Survey Party [___] GPS Receiver(s) [___] Vehicle(s) [___] Computer(s)				
	{Detail specific personnel/equipment requirements in applicable contract sections	[1]	CrewDay		
0009	Additional GPS Receiver				
	{Add Item 0006 observers as necessary}	[1]	Day		
0010	{Travel/Per Diem -- add line item if not included in above items}	[1]	Day		
0011	Survey Technical (Office Computer)	[1]	Day		
0012					
0013					

SECTION C

STATEMENT OF WORK

C.1 GENERAL. THE CONTRACTOR, OPERATING AS AN INDEPENDENT CONTRACTOR AND NOT AN AGENT OF THE GOVERNMENT, SHALL PROVIDE ALL LABOR, MATERIAL, AND EQUIPMENT NECESSARY TO PERFORM THE PROFESSIONAL SURVEYING *[AND MAPPING WORK] *[FROM TIME TO TIME] DURING THE PERIOD OF SERVICE AS STATED IN SECTION D, IN CONNECTION WITH PERFORMANCE OF *[_____] SURVEYS *[AND THE PREPARATION OF SUCH MAPS] AS MAY BE REQUIRED FOR *[ADVANCE PLANNING,] [DESIGN,] [AND CONSTRUCTION] [or other function] [ON VARIOUS PROJECTS] *[specify project(s)] . THE CONTRACTOR SHALL FURNISH THE REQUIRED PERSONNEL, EQUIPMENT, INSTRUMENTS, AND TRANSPORTATION, AS NECESSARY TO ACCOMPLISH THE REQUIRED SERVICES AND FURNISH TO THE GOVERNMENT REPORTS AND OTHER DATA TOGETHER WITH SUPPORTING MATERIAL DEVELOPED DURING THE FIELD DATA ACQUISITION PROCESS. DURING THE PROSECUTION OF THE WORK, THE CONTRACTOR SHALL PROVIDE ADEQUATE PROFESSIONAL SUPERVISION AND QUALITY CONTROL TO ASSURE THE ACCURACY, QUALITY, COMPLETENESS, AND PROGRESS OF THE WORK.

NOTE: The above clause is intended for use on an IDC contract for survey services. It is not exclusive to GPS-performed surveys. It may be used for Fixed-price service contract by deleting appropriate IDC language and adding the specific project survey required. This clause is not repeated on individual task orders.

C.2 LOCATION OF WORK.

NOTE: Use the following clause for a fixed-scope contract or individual work order.

C.2.1. *[STATIC] [KINEMATIC] SURVEYS USING NAVSTAR GPS EQUIPMENT WILL BE PERFORMED AT [...] *[list project area or areas required]. *[A MAP DETAILING THE WORK SITE IS ATTACHED AT SECTION G OF THIS CONTRACT.]

NOTE: Use the following when specifying an indefinite delivery contract for surveying and mapping services.

C.2.2. SURVEYING SERVICES WILL BE PERFORMED IN CONNECTION WITH PROJECTS *[LOCATED IN] [ASSIGNED TO] THE [_____] DISTRICT. *[THE _____ DISTRICT INCLUDES THE GEOGRAPHICAL REGIONS WITHIN *[AND COASTAL WATERS] [AND RIVER SYSTEMS] ADJACENT TO:]

* _____
{list states, regions, etc.}

NOTE: Note also any local points-of-contact, right-of-entry requirements, clearing restrictions, installation security requirements, etc.

C.3 TECHNICAL CRITERIA AND STANDARDS.

REFERENCE STANDARDS:

C.3.1. US ARMY CORPS OF ENGINEERS EM 1110-1-1003, NAVSTAR GPS SURVEYING. THIS REFERENCE IS ATTACHED TO AND MADE PART OF THIS CONTRACT. (SEE CONTRACT SECTION G).

C.3.2. US ARMY CORPS OF ENGINEERS ENGINEER MANUAL EM 1110-1-1002, SURVEY MARKERS AND MONUMENTATION. *[THIS REFERENCE IS ATTACHED TO AND MADE PART OF THIS CONTRACT. (SEE CONTRACT SECTION G).]

C.3.4. *[List other applicable USACE reference manuals and standards].

NOTE: Reference may also be made to other applicable Engineering Manuals or standard criteria documents. Such documents need not be attached to the Contract; if attached, however, reference should be made to their placement in contract Section G.

C.4 WORK TO BE PERFORMED. PROFESSIONAL NAVSTAR GPS SURVEYING AND MAPPING SERVICES TO BE PERFORMED UNDER THIS CONTRACT ARE LISTED BELOW. UNLESS OTHERWISE INDICATED IN THIS CONTRACT *[OR IN TASK ORDERS THERETO], EACH REQUIRED SERVICE SHALL INCLUDE FIELD-TO-FINISH EFFORT.

NOTE: The following clauses under this paragraph may be used for either Fixed-price service contracts, IDC work orders under an IDC contract, or IDC contracts where GPS control services are part of a schedule of various survey disciplines. Clearly identify the functional requirements of any GPS surveys, including recommended static or kinematic procedures.

Fixed-scope contracts: Detail specific GPS surveying and mapping technical work requirements and performance criteria, which are necessary to accomplish the work.

IDC contracts and work orders: Since specific project scopes are indefinite at the time a basic contract is prepared, only general technical criteria and standards can be outlined. Project or site-specific criteria will be contained in each task order, along with any deviations from technical standards identified in the basic IDC contract. The clauses contained herein are used to develop the general requirements for a basic IDC contract. Subsequent task orders will reference these clauses; adding project-specific work requirements as required. Task order formats should follow the outline established for the basic IDC contract.

C.4.1. GENERAL REQUIREMENTS (GPS SURVEYS). BASIC PROJECT CONTROL SURVEYS WILL BE PERFORMED USING PRECISE DIFFERENTIAL CARRIER-PHASE TRACKING NAVSTAR GPS MEASUREMENT PROCEDURES. DIFFERENTIAL GPS BASELINE VECTOR OBSERVATIONS WILL BE MADE IN STRICT ACCORDANCE WITH THE CRITERIA CONTAINED IN EM 1110-1-1003, EXCEPT AS MODIFIED OR AMPLIFIED HEREIN. THE GPS MEASUREMENT TECHNIQUE TO BE EMPLOYED IN MEASURING RELATIVE BASELINE VECTORS FOR *[PROJECT CONTROL] [PHOTO CONTROL] [TOPOGRAPHIC SITE PLAN MAPPING] IS *[STATIC] [STOP-AND-GO] [RAPID STATIC] [RTK] [PSEUDO-KINEMATIC], *[OR COMBINATIONS THEREOF]. *[CONVENTIONAL SURVEY METHODS WILL BE USED TO DENSIFY SUPPLEMENTAL POINTS RELATIVE TO ESTABLISHED GPS STATIONS.] *[SPECIFIC GPS BASELINES TO BE OCCUPIED AND OBSERVED IN THE DIFFERENTIAL MODE ARE INDICATED IN THESE SPECIFICATIONS.]

C.4.2. HORIZONTAL ACCURACY REQUIREMENTS. NEW *[PRIMARY] STATIONS SHALL BE ESTABLISHED TO A *[_]-ORDER, *[CLASS *[_]] RELATIVE ACCURACY CLASSIFICATION, OR *[_ PART IN _]. *[SUPPLEMENTAL TOPOGRAPHIC/PHOTOGRAMMETRIC MAPPING POINTS SHALL BE ESTABLISHED TO A *[_]-ORDER, *[CLASS *[_]] RELATIVE ACCURACY CLASSIFICATION, OR *[_ PART IN _].] *[GPS HORIZONTAL ACCURACY REQUIREMENTS SPECIFIED FOR NEWLY POSITIONED STATIONS SHALL BE BASED ON A FREE (UNCONSTRAINED) ADJUSTMENT OF OBSERVATIONS AND SHALL MEET THE RELATIVE ACCURACY AND/OR LOOP MISCLOSURE CRITERIA INDICATED IN EM 1110-1-1003.]

NOTE: Note that accuracy classifications, and related contract quality control and acceptance, are based on a free adjustment of the work -- not a constrained adjustment to fixed/existing control that often is of less accuracy than the new GPS work. GPS derived topographic mapping control need only meet general positional mapping requirements based on the site plan scale -- refer to ASPRS horizontal and vertical accuracy standards.

C.4.3. * VERTICAL ACCURACY REQUIREMENTS. GPS-DERIVED ELEVATIONS SHALL HAVE STANDARD ERRORS NOT EXCEEDING *[_] OR SHALL BE COMMENSURATE WITH THE CONTOUR INTERVAL OF THE FINAL TOPOGRAPHIC MAP BEING PRODUCED. ALL ELEVATION MEASUREMENTS DERIVED FROM GPS OBSERVATIONS SHALL BE PERFORMED IN ACCORDANCE WITH THE STANDARDS AND SPECIFICATIONS IN EM 1110-1-1003, AND SUPPLEMENTAL REFERENCES THEREOF.

NOTE: When GPS techniques are used to establish vertical elevations for photo or topo mapping projects, the required vertical accuracy must be specified. Extreme caution must be employed in specifying the use of GPS in densifying vertical control -- its application for engineering and construction work requires extensive redundancy.

C.4.4. PROCEDURAL OBSERVATION REQUIREMENTS. NETWORK DESIGN, STATION AND BASELINE OCCUPATION REQUIREMENTS FOR STATIC AND KINEMATIC SURVEYS, SATELLITE OBSERVING TIME PER BASELINE, BASELINE REDUNDANCIES, AND CONNECTION REQUIREMENTS TO EXISTING NETWORKS, SHALL FOLLOW THE CRITERIA GIVEN IN EM 1110-1-1003, EXCEPT AS MODIFIED IN THESE SPECIFICATIONS.

NOTE: At this point, indicate any exceptions, modifications, and/or deviations from EM 1110-1-1003. The specification writer may optionally elect to have the contractor design his observing procedures in accordance with general EM 1110-1-1003 criteria. Alternatively, specific baselines or stations requiring occupation may be specified. Use of either option depends on the GPS and geodetic survey experience/expertise of the specification writer. The preferred method is to allow the maximum flexibility be given to the contractor to determine the most optimum network design (interconnections, traverses, loops, spurs, etc.). In specifying baselines/points that have been monumented, contingencies should be allowed for resetting marks and/or eccentric observations due to obscured satellite visibility. Maximum use of more efficient kinematic control densification methods (as opposed to static methods) should be specified.

C.4.5. * SPECIFIC BASELINES TO BE MEASURED.

NOTE: Use the above clause only if the government specification writer is designing the network.

*(1) THE FOLLOWING BASELINES SHALL BE OBSERVED ON THIS PROJECT: [...]
*[list specific station-station baselines and any requirements for redundant observations]

*(2) THESE BASELINES ARE INDICATED BY [...] *[specify line symbol] ON THE ATTACHED MAP IN SECTION G.

C.4.6. NEW STATIONS TO BE *[MONUMENTED AND] OCCUPIED.

(1) THE FOLLOWING [...] *[indicate number of] STATIONS ARE TO BE OCCUPIED AND POSITIONED USING GPS SURVEY TECHNIQUES: *[list/tabulate new stations name and/or area designation, accuracy requirements (order/class), redundant occupations, etc.]

(2) THE NEW STATIONS *[GENERAL LOCATIONS] ARE INDICATED WITH A [...] *[indicate map symbol used] ON THE ATTACHED MAP. *[ACTUAL STATION LOCATION WITHIN THE GENERALLY DEFINED AREA SHALL BE SELECTED BY THE CONTRACTOR AND SHALL BE LOCATED SUCH THAT ADEQUATE SATELLITE VISIBILITY IS AFFORDED.]

C.4.7. EXISTING NETWORK CONTROL STATIONS TO BE OCCUPIED AND CONNECTED.

(1) A TOTAL OF [...] *[specify number of] EXISTING HORIZONTAL CONTROL STATIONS WILL BE USED TO REFERENCE HORIZONTAL GPS OBSERVATIONS ON THIS SURVEY. A LISTING OF THESE FIXED POINTS *[IS SHOWN BELOW] [IS SHOWN IN ATTACHMENT G.*]. FIXED COORDINATES ARE *[NAD 27] [NAD 83] [WGS 84 GEOCENTRIC] [...].

NOTE: List each existing control station(s) or, alternately, refer to a map or tabulation attachment in contract Section G.

(2) A TOTAL OF [...] [specify number] VERTICAL CONTROL STATIONS (BENCHMARKS) WILL BE OCCUPIED AND USED TO CONTROL AND/OR PROVIDE VERTICAL ORIENTATION REFERENCE TO GPS VERTICAL COMPONENTS. A LISTING OF THESE FIXED BENCHMARKS *[IS SHOWN BELOW] [IS SHOWN IN ATTACHMENT G.*]. ELEVATIONS FOR ALL FIXED BENCHMARKS ARE BASED ON *[NGVD 29] [NAVD 88] [IGLD-55] [...] DATUM. GEOID SEPARATION IS [...] [ASSUMED TO BE ZERO].

NOTE: list or reference attachment for existing benchmarks.

(3) REQUIRED GPS BASELINE CONNECTIONS TO EXISTING CONTROL IS SHOWN ON ATTACHMENT G.* IN SECTION G. THESE FIXED POINTS WILL BE USED IN PERFORMING A FINAL CONSTRAINED ADJUSTMENT OF ALL NEW WORK. HORIZONTAL POINTS ARE INDICATED BY A [...], VERTICAL POINTS BY A [...], COMBINED POINTS BY A [...], AND GPS BASELINES BY A [...].

NOTE: Use the above clause when existing control points to be connected are specified in the contract.

(4) ALL HORIZONTAL AND VERTICAL MONUMENTS ARE KNOWN TO BE IN-PLACE AS OF *[date]. DESCRIPTIONS FOR EACH POINT *[WILL BE PROVIDED PRIOR TO

CONTRACT AWARD] *[ARE ATTACHED AT CONTRACT SECTION G]. THE SOURCE AGENCY, AND ESTIMATED ACCURACY, OF EACH POINT IS INDICATED ON THE DESCRIPTION. *[A GPS OBSTRUCTION SKETCH IS SHOWN ON (HAS BEEN ADDED TO) THE DESCRIPTIONS.] *[IF SATELLITE VISIBILITY IS OBSCURED AT AN EXISTING STATION, THEN A NEW MARK SHALL BE SET AT THE RATE FOR ITEM [____] IN SECTION B.] *[THE CONTRACTOR'S FIELD REPRESENTATIVE SHALL IMMEDIATELY NOTIFY THE GOVERNMENT'S CONTRACTING OFFICER REPRESENTATIVE IF EXISTING CONTROL POINTS HAVE BEEN DISTURBED AND/OR SATELLITE VISIBILITIES ARE NOT AS INDICATED IN THE FURNISHED DESCRIPTIONS.]

NOTE: Use the following clause(s) only when network design and observation schedule/sequence will be determined by the contractor.

(5) * UNLESS OTHERWISE SPECIFIED IN THESE INSTRUCTIONS, AT LEAST *[ONE] [TWO] [THREE] [____] EXISTING (PUBLISHED) CONTROL STATIONS MUST BE OCCUPIED IN THE NETWORK. CONNECTION METHODS AND REDUNDANCY ARE AT THE CONTRACTOR'S OPTION. PRIOR TO USING ANY CONTROL POINTS, THE MONUMENTS SHALL BE CHECKED TO ENSURE THAT THEY HAVE NOT BEEN MOVED OR DISTURBED.

C.4.8. NEW STATION MONUMENTATION, MARKING, AND OTHER CONTROL REQUIREMENTS.

(1) ALL STATIONS SHALL BE MONUMENTED IN ACCORDANCE WITH EM 1110-1-1002, SURVEY MARKERS AND MONUMENTATION. MONUMENTATION FOR THIS PROJECT SHALL BE TYPE *[...] FOR HORIZONTAL AND TYPE *[...] FOR VERTICAL; PER EM 1110-1-1002 CRITERIA. *[MONUMENTATION SHALL BE DEFINED TO INCLUDE THE REQUIRED REFERENCE MARKS AND AZIMUTH MARKS REQUIRED BY EM 1110-1-1002.]. *[ALL MONUMENTS FOR NEW STATIONS ARE CURRENTLY IN PLACE AND DESCRIPTIONS ARE ATTACHED AT SECTION G.] *[IF SATELLITE VISIBILITY SHOWN ON THE DESCRIPTIONS IS OBSCURED AT AN EXISTING STATION, THEN A NEW MARK SHALL BE SET AT THE RATE FOR ITEM *[____] IN SECTION B.]

NOTE: Deviations from EM 1110-1-1002 should be indicated as required. USACE project control rarely requires supplemental reference/azimuth marks -- the optional specification clauses below should be tailored accordingly.

*(2) At each station, angle and distance measurements shall be made between a network station and reference marks and azimuth marks set that were established in accordance with the requirements set forth in EM 1110-1-1002. All observations shall be recorded in a standard field book.

*(a) For reference marks, two (2) directional positions are required (reject limit ± 10 " arc) and with steel taping performed to the nearest ± 0.01 foot.

*(b) Four directional positions are required to azimuth marks. The reject limit for a one-second theodolite is +5 seconds. Azimuth mark landmarks shall be easily defined/described natural features or structures that are of sufficient distance to maintain a $[\pm \text{____}]$ -second angular accuracy. $[\text{____}]$ -order astronomic azimuths shall be observed to azimuth marks.]

*(c) A compass reading shall be taken at each station to reference monuments and azimuth marks.

C.4.9. STATION DESCRIPTION AND RECOVERY REQUIREMENTS.

(1) STATION DESCRIPTIONS AND/OR RECOVERY NOTES SHALL BE WRITTEN IN ACCORDANCE WITH THE INSTRUCTIONS CONTAINED IN EM 1110-1-1002. [FORM *[_]] SHALL BE USED FOR THESE DESCRIPTIONS.] DESCRIPTIONS SHALL BE *[WRITTEN] [TYPED].

(2) DESCRIPTIONS *[ARE] [ARE NOT] REQUIRED FOR *[EXISTING] [AND/OR NEWLY ESTABLISHED] STATIONS.

(3) RECOVERY NOTES *[ARE] [ARE NOT] REQUIRED FOR EXISTING STATIONS.

C.4.10. MINIMUM OCCUPATION TIMES FOR OCCUPIED BASELINES. BASELINES SHALL BE OCCUPIED FOR A PERIOD OF TIME THAT IS CONSISTENT WITH THE SPECIFIED ACCURACY REQUIREMENT FOR THE PROJECT AND/OR PARTICULAR NEW STATION/LINE. RECOMMENDED MINIMUM OCCUPATION TIMES ARE CONTAINED IN EM 1110-1-1003. UNLESS OTHERWISE STATED IN THESE SPECIFICATIONS, THE CRITERIA SHOWN IN THIS MANUAL SHALL BE FOLLOWED FOR EACH PROJECT AND/OR OBSERVED BASELINE. MINIMUM OCCUPATION TIMES FOR KINEMATIC GPS SURVEY OBSERVATIONS SHALL BE CONSISTENT WITH MANUFACTURER RECOMMENDATIONS AND REQUIRED ACCURACIES OF TOPOGRAPHIC FEATURES.

C.4.11. TYPE AND NUMBER OF GPS RECEIVER UNITS TO BE DEPLOYED.

(1) THE CONTRACTING OFFICER RESERVES THE RIGHT TO REQUEST PUBLISHED DOCUMENTATION ON THE ACCURACY/QUALITY OF THE HARDWARE/SOFTWARE USED FOR THIS PROJECT. ALL GPS RECEIVERS AND POST-PROCESSING SOFTWARE USED UNDER THIS *[CONTRACT] [ASSIGNMENT] SHALL BE SUBJECT TO REVIEW BY THE CONTRACTING OFFICER. SYSTEM COMPONENTS SUBJECT TO REVIEW SHALL INCLUDE:

- (A) RECEIVERS
- (B) ANTENNAS
- (C) POWER SOURCE
- (D) DATA RECORDING UNITS AND STORAGE MEDIA
- (E) REAL-TIME OR POST-PROCESSING HARDWARE AND SOFTWARE

(2) A MINIMUM OF [...] GPS FIELD RECEIVER UNITS SHALL BE CONTINUOUSLY AND SIMULTANEOUSLY DEPLOYED DURING THIS *[TASK ORDER] [PROJECT].

NOTE: Add any applicable variations due to project specific requirements.

C.4.12. FIELD GPS OBSERVATION RECORDING PROCEDURES.

(1) FIELD LOG *[SHEETS] [FORMS] [NOTES] SHALL BE COMPLETED FOR EACH STATION OF EACH SESSION AND SUBMITTED TO THE GOVERNMENT. MINIMUM DATA

FOR STATIC AND KINEMATIC OBSERVATIONS TO BE INCLUDED ON THESE FIELD LOG RECORDS ARE DESCRIBED IN EM 1110-1-1003.

(2) RAW SATELLITE TRACKING DATA, BASELINE REDUCTION DATA, AND ADJUSTMENT SOLUTIONS SHALL BE RECORDED AND SUBMITTED TO THE GOVERNMENT ON *[_-INCH FLOPPY DISKS] [A PRE-APPROVED MEDIUM].

(3) IT SHALL BE THE RESPONSIBILITY OF THE CONTRACTOR TO ASSURE THAT AMPLE OBSERVATIONS ARE CONDUCTED SO THAT ALL POINTS ARE INTERCONNECTED IN A COMPLETE INTERCONNECTING NETWORK OR GPS TRAVERSE SURVEY; AND/OR IN ACCORDANCE WITH THE REQUIRED BASELINE MEASUREMENTS SPECIFIED HEREIN. *[ADEQUATE FIELD COMPUTATIONAL CAPABILITY SHALL EXIST IN ORDER TO VERIFY MISCLOSURES PRIOR TO SITE DEPARTURE.]

C.4.13. BASELINE DATA REDUCTION REQUIREMENTS (CONTROL SURVEYS).

(1) SOFTWARE FOR POST-PROCESSING OF SATELLITE TRACKING DATA SHALL BE SUBJECT TO APPROVAL BY THE CONTRACTING OFFICER. ALL SOFTWARE MUST BE ABLE TO PRODUCE FROM THE RAW DATA RELATIVE POSITION COORDINATES *[AND CORRESPONDING VARIANCE-COVARIANCE STATISTICS WHICH IN TURN CAN BE USED AS INPUT TO THREE-DIMENSIONAL NETWORK ADJUSTMENT PROGRAMS.]

NOTE: Baseline output statistics are generally only specified when rigorous least-squares adjustments are required; and then only if the specified adjustment software utilizes such statistics. This is not applicable to topographic surveying uses of GPS.

(2) BASELINE PROCESSING SHALL BE COMPLETED FOR ALL BASELINES AND SELECTED FOR USE IN THE FINAL NETWORK ADJUSTMENT BASED ON AN ANALYSIS OF THE STATISTICAL DATA AND RELATIVE SPATIAL RELATIONSHIPS BETWEEN POINTS. TEST CONSTANTS GIVEN FOR A PARTICULAR SOFTWARE SYSTEM SHALL BE COMPARED TO THE PROCESSED RESULTS AND ANY SUSPECT BASELINE THAT DOES NOT MEET THE CRITERIA SHALL BE REOBSERVED OR NOT INCLUDED IN THE FINAL ADJUSTMENT. BASELINE ACCEPTANCE AND REJECTION CRITERIA ARE CONTAINED IN EM 1110-1-1003.

C.4.14. FINAL ADJUSTMENT REQUIREMENTS (CONTROL SURVEYS). GPS SURVEY TRAVERSE LOOPS AND NETWORKS SHALL BE ADJUSTED AND EVALUATED IN ACCORDANCE WITH THE PROCEDURES AND CRITERIA OUTLINED IN EM 1110-1-1003. FINAL VECTOR MISCLOSURES MAY BE PROPORTIONATELY DISTRIBUTED AMONGST THE OBSERVED VECTORS USING EITHER APPROXIMATE OR LEAST-SQUARES ADJUSTMENT TECHNIQUES DESCRIBED IN EM 1110-1-1003.

(1) ADJUSTMENTS ARE NORMALLY PERFORMED USING X-Y-Z GEOCENTRIC COORDINATES RELATIVE TO THE WGS 84 SPHEROID. TRANSFORMED FINAL ADJUSTED HORIZONTAL DATA SHALL BE EXPRESSED IN *[SPCS] [UTM] [GEOGRAPHIC] [GEOCENTRIC] [OTHER] COORDINATES, AND SHALL BE REFERENCED TO *[NAD 27] [NAD 83] [PROJECT] DATUM. FINAL COORDINATES SHALL BE TABULATED IN *[METERS] [FEET] [other] TO ONLY *[_] DECIMAL POINTS OF PRECISION. *[FINAL ADJUSTED VERTICAL DATA FOR TOPOGRAPHIC MAPPING APPLICATIONS SHALL BE SHOWN AS

ORTHOMETRIC HEIGHTS ON *[NGVD 29] [NAVD 88] [other] VERTICAL DATUM. GPS-DERIVED ELEVATIONS SHALL BE ROUNDED TO THE NEAREST *[METER] [FOOT].]

* (2) FOR PROJECT CONTROL SURVEYS AN ADJUSTMENT ANALYSIS SHALL INCLUDE THE FOLLOWING:

* (a) GPS TRAVERSE LOOPS SHALL BE ANALYZED RELATIVE TO THE INTERNAL CLOSURE CRITERIA GIVEN IN EM 1110-1-1003. INTERNAL ACCEPTABILITY OF THE WORK WILL BE BASED ON THE MAGNITUDE OF THE THREE-DIMENSIONAL VECTOR MISCLOSURES RELATIVE TO THE LOOP LENGTH. SUCH LOOP CLOSURE ANALYSIS WILL BE CONSIDERED THE INTERNAL, MINIMALLY-CONSTRAINED, FREE ADJUSTMENT. LOOPS/LINES WITH INTERNAL MISCLOSURE RATIOS IN EXCESS OF THOSE SPECIFIED IN THIS CONTRACT SHALL BE REOBSERVED. MISCLOSURES BETWEEN EXTERNAL FIXED CONTROL MAY BE DISTRIBUTED USING THE APPROXIMATE DISTRIBUTION METHODS GIVEN IN EM 1110-1-1003. FINAL CONSTRAINED ACCURACY ESTIMATES WILL BE BASED ON RELATIVE MISCLOSURES AT FIXED POINTS.

(b) * WHEN A FREE (OR MINIMALLY CONSTRAINED) LEAST-SQUARES ADJUSTMENT IS PERFORMED ON THE BASELINE VECTORS, A CLASSIFICATION BASED ON THIS INTERNAL ADJUSTMENT SHALL BE DERIVED AND EVALUATED AGAINST THE MINIMUM ALLOWABLE STANDARDS SHOWN IN EM 1110-1-1003 FOR THE GIVEN REQUIRED ACCURACY. THIS FREE ADJUSTMENT, ALONG WITH AN ANALYSIS OF THE BASELINE REDUCTION DATA, WILL BE USED IN EVALUATING THE CONTRACTUAL ACCEPTABILITY OF THE OBSERVED NETWORK. STATION *[_____] SHALL BE HELD FIXED FOR THIS UNCONSTRAINED ADJUSTMENT. THE NORMALIZED RESIDUALS SHALL BE COMPUTED AND ANALYZED RELATIVE TO THE CRITERIA CONTAINED IN EM 1110-1-1003. THE VARIANCE OF UNIT WEIGHT FOR THE MINIMALLY CONSTRAINED NETWORK ADJUSTMENT SHALL CONFORM TO THE CRITERIA GIVEN IN EM 1110-1-1003. RELATIVE LINE ACCURACIES SHALL BE COMPUTED FOR PAIR OF POINTS ON THE NETWORK USING STATISTICAL DATA CONTAINED IN THE FREE ADJUSTMENT. THESE RELATIVE LINE ACCURACIES SHALL NOT EXCEED THE REQUIRED ACCURACY CLASSIFICATIONS PRESCRIBED FOR THE WORK. STATIONS/BASELINES/NETWORK AREAS WITH FREE ADJUSTMENT RELATIVE ACCURACIES NOT MEETING THE REQUIRED CRITERIA MUST BE REOBSERVED; IT IS THEREFORE CONTINGENT ON THE CONTRACTOR TO INSURE THAT MISCLOSURE TOLERANCES ARE CHECKED IN THE FIELD.

(c) * A CONSTRAINED LEAST-SQUARES ADJUSTMENT WILL BE PERFORMED HOLDING *[FIXED] [PARTIALLY CONSTRAINED] THE COORDINATES OF THE STATIONS LISTED UNDER THE EXISTING CONTROL CLAUSE IN THIS CONTRACT SECTION. FOR THE PURPOSE OF THESE SPECIFICATIONS, BOTH FULLY CONSTRAINED AND PARTIALLY CONSTRAINED POINTS ARE REFERRED TO AS "FIXED" POINTS. THE CONSTRAINED LEAST-SQUARES ADJUSTMENT SHALL USE MODELS WHICH ACCOUNT FOR: THE REFERENCE ELLIPSOID FOR THE REFERENCE CONTROL, THE ORIENTATION AND SCALE DIFFERENCES BETWEEN THE SATELLITE AND NETWORK CONTROL DATUMS, GEOID-ELLIPSOID RELATIONSHIPS, AND DISTORTIONS AND/OR RELIABILITY IN THE NETWORK CONTROL.

NOTE: A variety of free and/or constrained adjustment combinations may be specified. Specific stations to be held fixed may have been indicated in a prior contract section or the contractor may be instructed to determine the optimum adjustment, including appropriate weighting for constrained points. When fixed

stations are to be partially constrained, then appropriate statistical information must be provided -- either variance-covariance matrices or relative positional accuracy estimates which may be converted into approximate variance-covariance matrices in the constrained adjustment.

[1] *WHEN DIFFERENT COMBINATIONS OF CONSTRAINED ADJUSTMENTS ARE PERFORMED DUE TO INDICATIONS OF ONE OR MORE FIXED STATIONS CAUSING UNDUE BIASING OF THE DATA, AN ANALYSIS SHALL BE MADE AS TO A RECOMMENDED SOLUTION WHICH PROVIDES THE BEST FIT FOR THE NETWORK. ANY FIXED CONTROL POINTS WHICH SHOULD BE READJUSTED (TO ANOMALIES FROM THE ADJUSTMENT(S)) SHOULD BE CLEARLY INDICATED IN A FINAL ANALYSIS RECOMMENDATION.

[2] *THE FINAL ADJUSTED HORIZONTAL AND/OR VERTICAL COORDINATE VALUES SHALL BE ASSIGNED AN ACCURACY CLASSIFICATION BASED ON THE LEAST-SQUARES ADJUSTMENT STATISTICAL RESULTS AND IN ACCORDANCE WITH THE CRITERIA INDICATED IN EM 1110-1-1003. THIS CLASSIFICATION SHALL INCLUDE BOTH THE RESULTANT GEODETIC/CARTESIAN COORDINATES AND THE BASELINE DIFFERENTIAL RESULTS. THE FINAL ADJUSTED COORDINATES SHALL STATE THE 95% CONFIDENCE REGION OF EACH POINT AND THE 95% RELATIVE LINE ACCURACY IN PARTS PER MILLION (PPM) BETWEEN ALL POINTS IN THE NETWORK.

(3) *FINAL ADJUSTED COORDINATE LISTINGS SHALL BE PROVIDED ON HARD COPY *[AND ON *[_] [specify] COMPUTER MEDIA].

(4) * A SCALED PLOT SHALL BE SUBMITTED WITH THE ADJUSTMENT REPORT SHOWING THE PROPER LOCATIONS AND DESIGNATIONS OF ALL STATIONS ESTABLISHED.

C.5 SUBMITTAL REQUIREMENTS:

C.5.1. SUBMITTAL SCHEDULE: THE COMPLETED SURVEY REPORT SHALL BE DELIVERED WITHIN *[_] DAYS AFTER NOTICE TO PROCEED IS ISSUED] *[BY calendar date]

NOTE: Include a more detailed submittal schedule breakdown if applicable to project.

C.5.2. SUBMITTED ITEMS: SUBMITTALS SHALL CONFORM THOSE SPECIFIED IN EM 1110-1-1003 *[EXCEPT AS MODIFIED HEREIN].

NOTE: Reference should be made to EM 1110-1-1003 for typical GPS survey submittal requirements. Modify and/or add items as required.

C.5.3. PACKAGING AND MARKING: PACKAGING OF COMPLETED WORK SHALL BE ACCOMPLISHED SUCH THAT THE MATERIALS WILL BE PROTECTED FROM HANDLING DAMAGE. EACH PACKAGE SHALL CONTAIN A TRANSMITTAL LETTER OR SHIPPING FORM, IN DUPLICATE, LISTING THE MATERIALS BEING TRANSMITTED, BEING PROPERLY NUMBERED, DATED AND SIGNED. SHIPPING LABELS SHALL BE MARKED AS FOLLOWS:

US ARMY ENGINEER DISTRICT, _____

ATTN: _____
*[include office symbol and name]

CONTRACT NO. _____

*[TASK ORDER NO. _____]

[STREET/PO BOX] _____

*[complete local mailing address]

*HAND CARRIED SUBMISSIONS SHALL BE PACKAGED AND MARKED AS ABOVE, AND DELIVERED TO THE FOLLOWING OFFICE ADDRESS:

*[insert office/room number as required]

NOTE: In this section, also reference any automated data submittal requirements for GPS observations, if applicable.

C.6 PROGRESS SCHEDULES AND WRITTEN REPORTS.

C.6.1. *PRE-WORK CONFERENCE:

NOTE: Detail any requirements for a Prework conference after contract award, including requirements for preparing written reports for such conferences. Most of the following sections are completed by the District's Contracting Office.

SECTION D

CONTRACT ADMINISTRATION DATA

SECTION E

SPECIAL CONTRACT REQUIREMENTS

SECTION F

CONTRACT CLAUSES

SECTION G

LIST OF ATTACHMENTS

G.1. US ARMY CORPS OF ENGINEERS EM 1110-1-1003, NAVSTAR GPS SURVEYING. THIS REFERENCE IS ATTACHED TO AND MADE PART OF THIS CONTRACT.

NOTE: List any other attachments called for in contract section C or in other contract sections. This includes items such as:

- Marked-up project sketches/drawings.
- Station/Monument descriptions or Recovery Notes.
- Lists of baseline connections to existing network.
- Lists of fixed (existing) stations to be connected with and adjusted to.

SECTION H

**REPRESENTATIONS, CERTIFICATIONS AND OTHER
STATEMENTS OF OFFERERS**

SECTION I

INSTRUCTIONS, CONDITIONS, AND NOTICES TO OFFERERS

Appendix D
Application: Dredge Material Disposal Area RTK Cross-Sections--
(Jacksonville District)

D-1. Sample RTK Survey of Maintenance Dredging Confined Disposal Area

The following RTK topographic surveying example is representative of the procedures used for most Corps engineering and construction applications. This example depicts a topographic survey of the levee surrounding the dredge disposal area. These cross-sections were performed on the Quarantine Island disposal area in the St. Johns River, near Jacksonville, Florida. The disposal area is west of Cuts F and G on the navigation project where the material was excavated. The dredging measurement and payment hydrographic surveys in the navigation channel and the RTK surveys in the disposal area placement area were performed for the Jacksonville District by Arc Surveying & Mapping, Inc.

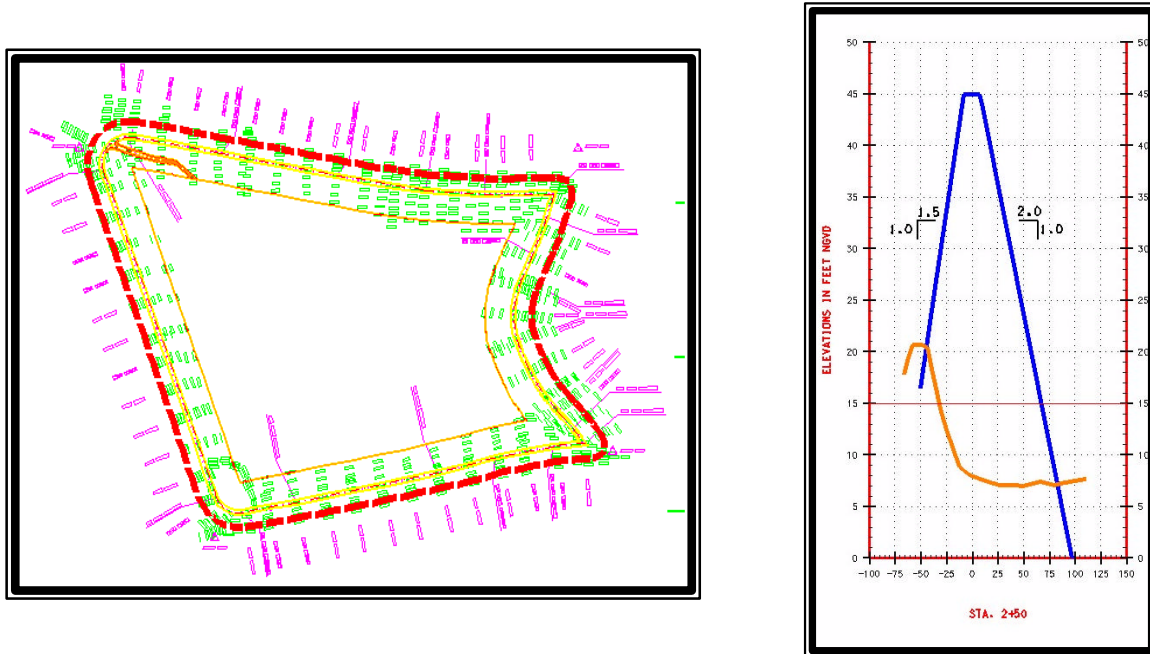

Figure D-1. Plan of confined disposal area and typical section

Figure D-1 above shows a plan of the entire disposal area, over which cross-sections were obtained using RTK techniques. The example data in this appendix covers only a few sections taken on the northerly edge of the disposal area. A typical levee design section at Station 2+00 is shown at the right.

The sketch below (Figure D-2) depicts the layout for the RTK survey. The base receiver was set over ST JO 335 and the 14 representative cross-sections shown were observed relative to that point. Elevations ranged from around 45 feet at the top of the constructed levee down to 15 feet at the toe. Elevations were referenced and adjusted to NGVD 29. ST JO 336 was used as an elevation and position check point for the RTK set up. RTK field data collection procedures followed the methods described in Chapter 9 of this manual.

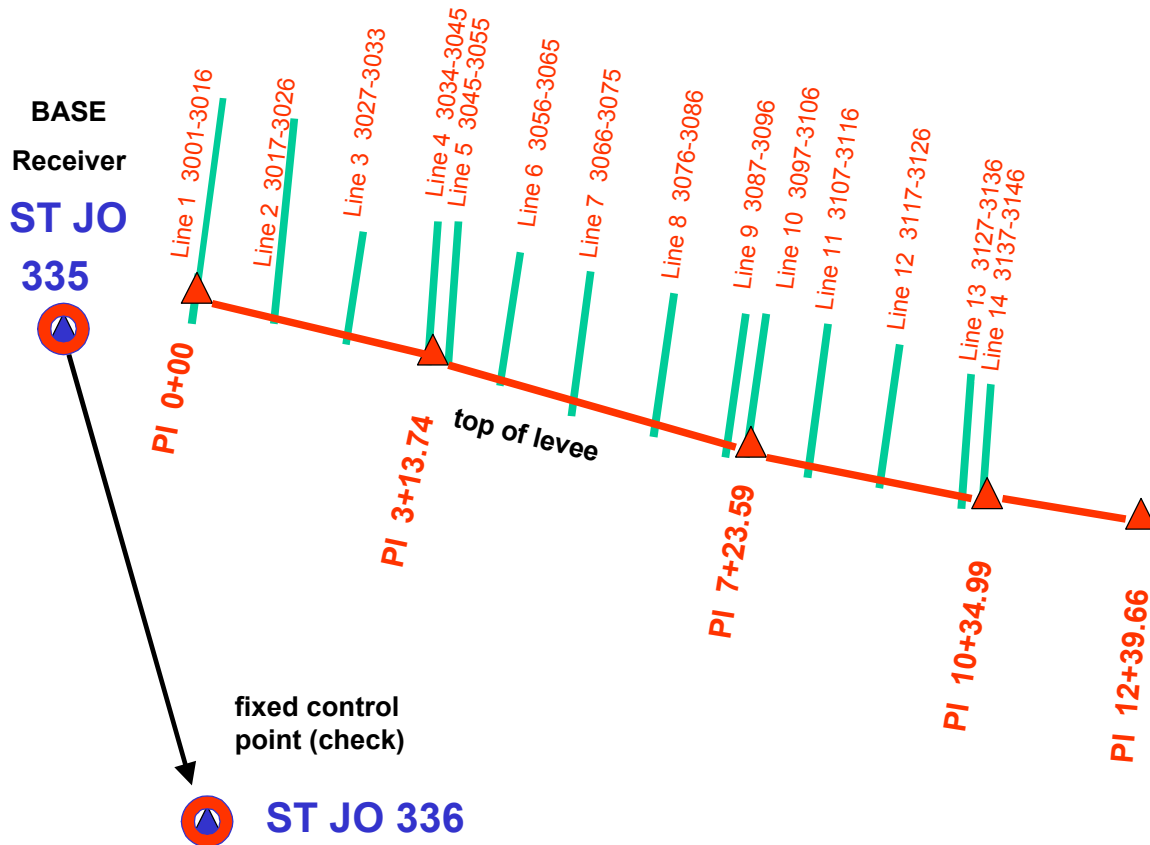

Figure D-2. Disposal area survey fixed control points and baseline layout

The screen capture below (from Trimble Geomatics Office) shows the 14 selected cross-sections, over which a total of 145 topo points were observed on the disposal area embankment. A Trimble RTK system was used to perform the survey and Trimble Geomatics Office software was used to reduce the data. The reference receiver was located at benchmark ST JO 335 (just off the left of the screen), the point whose position and elevation were held fixed for the survey. RTK vector observations to each shot point are shown as rays emanating from ST JO 335. The shot points are numbered from 3001 to 3147, in sequence. Cross-sections were run in alternate directions up and down the embankment.

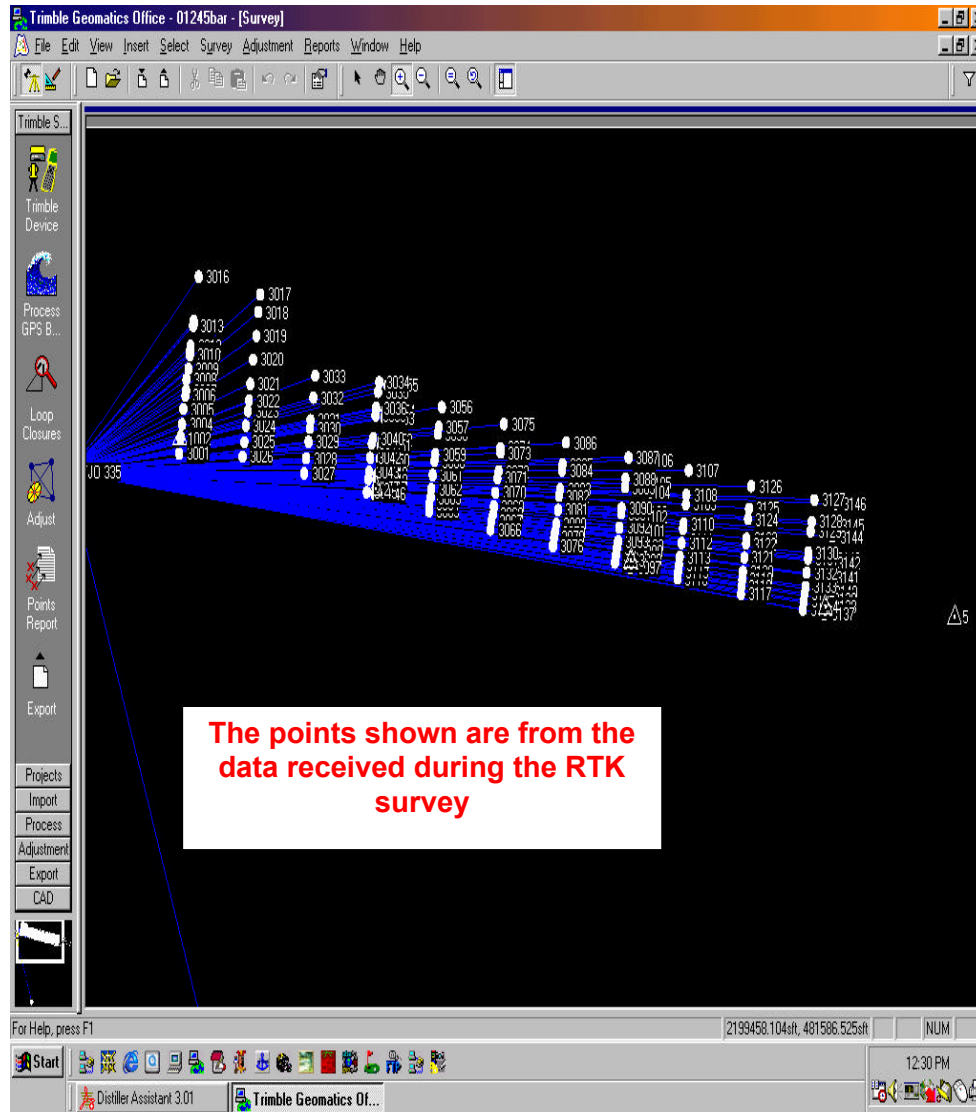

Figure D-3. Trimble Geomatics Office plot of observed RTK vectors and topo points

D-2. Request for Proposal and Scope of Work

The following Request for Proposal, along with the technical scope of work, is an example of a labor-hour (not-to-exceed) task order designed to provide surveying support for a long-term construction project. This task order provides for periodic pre-, during-, and post-construction surveys; including GPS-controlled hydrographic surveys of the channel excavation and GPS/RTK-controlled profile surveys of the placement area. The task order additionally requires the contractor to compute payment volumes for the excavated and placed material.

Engineering Division
Design Branch

Mr. John Sawyer
ARC Surveying and Mapping
5202 San Juan Ave
Jacksonville, Florida 32210

SUBJECT: Contract No. DACW17-01-D-0002

Dear Mr. Sawyer:

Reference contract number DACW17-01-D-0002 for Surveying and Mapping Services. The Government desires to execute a delivery order under subject contract for the following project:

**Jacksonville Harbor Construction Dredging Phase I DACW17-01-C-0023
38 Foot Project Cut-F Through Cut-G Construction Survey
Jacksonville, Florida (Survey 01-245)**

Please review the enclosed scope of work outlining the Technical Requirements and submit an itemized fee proposal for this work within 10 working days of receipt of this document. Please furnish this fee proposal to the attention of the Chief, Design Branch.

This request does not constitute a notice to proceed for the delivery order. Please do not commence work or incur any costs chargeable to the Government. You are cautioned that preparation of this fee proposal is entirely at your own risk and the Government can assume no obligation for payment of any related expenses incurred by your firm.

Mr. Jerry Burchfield of Survey Section is the point of contact. Please call him at 904-232-1613 if you have questions or need additional information.

Sincerely,

Edward E. Middleton, PhD., P.E.
Chief, Engineering Division

**TECHNICAL QUALITY CONTROL REQUIREMENTS
JACKSONVILLE HARBOR CONSTRUCTION DREDGING PHASE I AND PHASE II
DACW17-01-C-0023 38 FOOT PROJECT CUT-F THROUGH CUT-G
DACW17-01-C-0013 40 FOOT PROJECT CUT-3 THROUGH CUT-50
PRE, DURING AND POST CONSTRUCTION SURVEYS
JACKSONVILLE, FLORIDA (SURVEY 01-245)**

1. LOCATION OF WORK. The project is located in Duval County at Jacksonville, Florida.

2. SCOPE OF WORK.

2.a. The services to be rendered by the Contractor include obtaining topographic and hydrographic Pre, During, and Post construction surveys, CADD data, and volumes.

2.b. The services to be rendered by the Contractor include all the work described in these technical requirements. Details not specifically described in these instructions are nevertheless a firm requirement if they can be identified as an item, or items, commonly a part of professional grade work of a comparative nature.

2.c. The Contractor shall furnish all necessary materials, labor, supervision, equipment, and transportation necessary to execute and complete all work required by these specifications.

2.d. COMPLIANCE. Surveying and Mapping shall be in strict compliance with EM-1110-1-1000 Photogrammetric Mapping, EM-1110-1-1002 Survey Markers and Monumentation, EM-1110-1-1003 NAVSTAR Global Positioning System Surveying, EM-1110-1-1004 Deformation Monitoring and Control Surveying, EM-1110-2-1003 Hydrographic Surveying, EM-1110-1-2909 Geospatial Data and System, Tri-Services A/E/C CADD Standards, Tri-Services Spatial Data Standards, Related Spatial Data Products and Chapter 177, Chapter 472, and Chapter 61G17 of the Minimum Technical Standards set by the Florida Board of Professional Surveyors and Mappers.

2.d(1) Digital Geospatial Metadata. Metadata are "data about data". They describes the content, identification, data quality, spatial data organization, spatial reference, entity and attribute information, distribution, metadata reference, and other characteristics of data. Each survey project shall have metadata submitted with the final data submittal. All metadata submitted must be compliant with the Federal Geographic Data Committee Standard "Content Standard for Digital Geospatial Metadata", FGDC-STD-001-1998. This standard is available for download from www.fgdc.gov. A graphical, annotated workbook explaining the standard is available in PDF format at www.fgdc.gov.

2.d(2) Furnish a digital file using Corpsmet95 Metadata Software. Corpsmet95 is available for download from www.corpsgeo1.usace.army.mil. All sections applicable to this collection effort must be completed. The point of contact in Survey Section for questions about metadata is Mr. Bill Mihalik at 904-232-1462.

2.e. The digital data shall be submitted on Recordable (CD-R) Compact Disk, media. Compact Disk, Rewritable (CD-RW) will not be accepted.

2.f. SUBMITTALS AND POINTS OF CONTACT. The points of contact are, Mr. Son Q. Vu at 904-232-1606, Mr. Dave Robar at 904-232-1458 (Jacksonville District Office), and Mr. Tommy Gaskins at 904-232-2144 (North Florida Area Office) mobile 904-614-9476. The survey Contractor shall furnish data directly to the North Florida Area Office within 24 hours after the survey data is collected in the field.

2.f(1) The survey Contractor shall furnish to the South Florida Area Office, letter size (8 1/2" x 11") cross sections plots by fax or hand carry. The plots for the pre survey shall depict the plans and specification survey, the design template, and the pre survey. The plots for the after survey shall depict the plans and specification survey, the design template, the pre survey and after survey.

2.f(2) The survey Contractor shall furnish to the South Florida Area Office standard Corps of Engineers size plan view plots, utilizing the sheet layout shown in Enclosure 1, Contract Plans. The Contractor shall also place all cross sections into one or more standard Corps of Engineers size sheet and furnish plots within 48 hours.

TECHNICAL QUALITY CONTROL REQUIREMENTS (Continued)

2.f(3) The Contractor shall perform quantity calculations by the average end area method. The quantities shall be determined by passing the required grade template along both surveys. The quantities shall be furnished to the North Florida Area Office (Hard Copy), Mr. Tommy Gaskins and Survey Section Jacksonville District (DIGITAL COPY).

2.f(4) The survey Contractor shall furnish any and all data requested by the North Florida Area Office, this includes the COPIES OF THE FIELD BOOKS, HARD COPY MAPS, DIGITAL FILES (X, Y, Z, DGN, OR DTM) AND VOLUMES. All data (copies or plots) shall be stamp with a disclaimer such as PRELIMINARY OR ADVANCE COPY, FOR FIELD REVIEW ONLY, SUBJECT TO CORRECTIONS. The digital data shall be uploaded to the FTP site under the Contractor's directory. Survey section shall be furnished only digital data NO PLOTS.

2.f(5) The survey Contractor shall furnish daily reports, which verifies work effort by line items to EN-DT (Jacksonville District, Survey Section).

2.f(6) For each submittal all of the following files must be submitted if applicable:

- Raw data files
- XYZ ASCII files (unsorted)
- DGN design files
- DTM surface files
- ALG alignment files
- TML template files
- RWL roadway files
- Volume/Quantity reports
- Readme files that explicitly detail the files submitted (including any special circumstances)
- Daily Log of survey activities at the project site (this can be part of the Readme file)

The directory structure should be as follows:

Jax FTP

 Company Name

 Survey Number

 Pre (pre-construction)

 YYYYMMDD (date posted)

 Intermit (intermittent surveys and check surveys)

 YYYYMMDD

 Post (post-construction)

 YYYYMMDD

2.f(7) The final data shall be submitted on CD-ROM after at the conclusion of the project and under the direction of the Jacksonville District Survey Section, a final project CD will be compiled and submitted. The CD will contain all of the partial project data sets posted to the FTP site in addition to a final overall set of files for the project (single overall DGN, etc.). Notify David Robar at the Jacksonville District Office via email or telephone when data has been posted.

2.f(8) NOT TO EXCEED. It was emphasized that the amount that is stated in this delivery order is a "NOT TO EXCEED" amount. The Contractor shall not provide services in excess of 85% of this total amount without first receiving written authorization from the Contracting Officer. Payments will be made on the fixed unit prices of the task order for services performed, as reflected by daily work reports submitted with the payment estimates. Upon completion of all services, if the total amount for services provided is less than the stated amount, the price of the delivery order will be modified to reflect services actually performed and accepted. To certify the hours worked and progress, a daily report shall be furnished directly to the Corps of Engineers, Design Branch, from the field party employed and signed by the Project Office representative. Weekly submittal is acceptable. The Contractor's work hours and work days may have to be adjusted to coincide with the construction Contractor, at no additional cost to the Government.

3. FIELD SURVEY EFFORT. Pre, During, and Post Construction beach surveys shall be collected for Contract DACW17-01-C-0023 as shown in Enclosure 1, Contract Plans And Specifications. Enclosure 2 is the technical requirements for the surveys. Enclosure 3 is CD with the plans and specification surveys.

TECHNICAL QUALITY CONTROL REQUIREMENTS (Continued)

3.a. CONTROL. The Horizontal datum shall be NAD 83 and the vertical datum shall be NGVD 1929 with a MLW datum applied. The MLW datum is shown in Enclosure 1. All control surveys shall be Third Order, Class II accuracy.

3.a(1) The basic control network shall be accomplished using precise differential carrier-phase Global Positioning System (GPS) and Differential GPS baseline vector observations.

3.a(2) Network design, station and baseline occupation requirements, for static and kinematic surveys, satellite observation time per baseline, baseline redundancies, and connection requirements to existing networks, shall follow the criteria given in the above said engineering manual. The field observation log shall be completed at each setup in the field.

3.a(3) GPS derived elevation data shall be supplied in reference to the above said datum. Existing benchmark data and stations shall be used in tandem in a minimally constrained adjustment program to model the geoid. All supporting data used in vertical adjustment shall be submitted to Survey Section. The GPS plan shall be submitted and approved by Mr. Robar prior to commencing work.

3.a(4) Existing Corps of Engineers control data shall be utilized for controlling the surveys. No control monuments shall be utilized that are not included in Enclosure 1. All established or recovered control shall be fully described and entered in a FIELD BOOK, in accordance with the Technical Requirements of this contract. All control surveys shall be Third Order, Class II accuracy.

3.a(5) All horizontal and vertical control (double run forward and back) established shall be a closed traverse or level loop no spur lines, with third order accuracy. All horizontal and vertical control along with baseline layouts, sketches, and pertinent data shall be entered in field books.

3.a(6) All monuments, survey markers, etc., recovered shall be noted in the FIELD BOOK. Control points established or recovered with no description or out-of-date (5 Years old) description shall be described with sketches in the FIELD BOOK for future recovery use.

3.a(7) All original field notes shall be kept in standard pocket size field books and shall become the property of the Government. The first four pages of the field books shall be reserved for indexing and the binding outside edge shall be free of all marking.

3.b. TIDE STAFF. Establish an on-site tide staff referenced to mean low water. Maintain a 0.1' frequency reading log during the water portion of the survey. Tide staff shall be set at the project sites.

3.c. QUANTITY SURVEYS. Topographic and Hydrographic cross sections shall be collected on even 100 foot station intervals for the disposal area and the channels.

3.d. ACOUSTIC MULTIBEAM DATA. Multibeam data shall be collected for final acceptance of the channel (reference COE Hydrographic Manual).

3.e. NAVAIDS. All Navigation's Aids (NAVAIDS) shall be located with coordinate positions (GPS) in or adjacent project area. Fixed NAVAIDS shall be positioned four to five times and floating NAVAIDS shall be positioned one time, with wind and tide direction recorded. Note type and condition of NAVAIDS within the project limits. Waning signs, lights, and any existing regulatory markers, (information signs) within the project limits shall be positioned four to five times. Locate all NAVAIDS in the entrance channel.

3.f. DGPS. The hydrographic positioning system shall be a Differential Global Positioning System utilizing the USCG Nav-beacon system as the reference station. The positioning system shall be checked with two control monuments and recorded along with setup data (input data to the GPS) in the field book. Hydrographic survey log sheets shall be filled out and submitted along with the field book.

3.g. SOUNDING POLE 6" DISK. Utilize a 6 inch diameter disk attached to the bottom of the sounding pole or lead line at all times when collecting conventional soundings.

3.h. BREAKLINE. Breaklines shall be located for all natural or man-make features as needed with X, Y, and Z and identified.

TECHNICAL QUALITY CONTROL REQUIREMENTS (Continued)

3.i. DATA COLLECTION (RTK or TOTAL STATION). Data collection will be allowed for data points only, showing all instrument positions, calibration, backsites and closing readings in the field book. Mr. Robar shall be contacted if you plan to use GPS (RTK) before utilizing. If RTK is utilized Q1 and Q2 files shall be furnished. Before using RTK, one session shall be performed around the expected survey area. After observation of the primary control (four monuments; one on each corner of the work area) the geoid model shall be prepared utilizing the four occupied monument's data. The geoid model shall be furnished to the Corps of Engineers for review and acceptance. CAUTION, unless the one session is observed with the four monuments before modeling the geoid, all data will be rejected and returned to the Contractor.

4. DATA PROCESSING. The Contractor shall make the necessary computations to verify the correctness of all measurements and apply the proper theory of location in accordance with the law or precedent and publish the results of the survey. The Contractor shall submit advance copies of the horizontal control so that USACE can compute the final positions before commencing mapping. Compute and tabulate the horizontal and vertical positions on all work performed. Review and edit all field data for discrepancies before plotting the final drawings.

4.a. Furnish X, Y, Z and descriptor ASCII file for profile line and or each cross section line and one X, Y, Z, and descriptor ASCII file with all data included.

5. CADD. The survey data shall be translated or digital capture into Intergraph IGDS 3D design files according to the specifications furnished. The survey data shall be provided in Intergraph MicroStation Version 5.0 or higher, as shown in the letter dated 30 September 1992.

5.a. GLOBAL ORIGIN. The IGDS 3-D design file shall be prepared with a global origin of 0, 0, 2147483.65, Design file master units: FT., Sub units: 1,000, and positional units: 1. The file name shall be the survey number prefixed to an "c" i.e., c245.DGN.

5.b. DIGITAL TERRAIN MODEL (DTM) DATA. The Contractor shall develop and deliver a surface model of the survey area using Intergraph compatible Digital Terrain Modeling software and the model file shall have the .dtm extension. The digital terrain model shall be developed from the collected data. Breaklines should include ridges, drainage, road edges, surface water boundaries, and other linear features implying a change in slope. The surface model shall be of adequate density and quality to produce a one foot contour interval derived from the original DTM (Digital Terrain Model) file. The contour data shall be incorporated as a reference file into the final data set. All data used to develop the DTM's shall be delivered in Intergraph 3-D design files.

5.b(1) CONTOURS. The contours shall be developed in the digital terrain model (DTM). The contours shall be provided in one or more master DGN files, attached as a reference file to all sheet files utilizing the clip bounds methods. Each contour shall be drawn sharp and clear as a continuous solid line, dashed contours are not acceptable. Every index contour shall be accentuated as a heavier line than the intermediate and shall be annotated according to its actual elevation above NGVD 29 MLW. Whenever index contours are closer than one-quarter (1/4) inch, and the ground slope is uniform, the intermediate shall be omitted. Labeling or numbering of contours shall be placed on top of the contour line, so that the elevation is readily discernible, do not break contours. Labeling of intermediate contours may be required in areas of low relief.

5.c. MODEL DGN FILES (SCALE 1:1).

5.c(1) The topographic data points shall be provided in one or more DGN file.

5.c(2) The hydrographic data points shall be provided in one or more DGN file.

5.c(3) The control and baseline data points shall be provided in one or more master DGN file attached as a reference file to all sheet files utilizing the clip bounds methods.

5.c(4) The contours shall be provided in one or more DGN file attached as a reference file to all sheet files utilizing the clip bounds methods.

5.c(5) The breaklines shall be provided in one or more master DGN file attached as a reference file to all sheet files utilizing the clip bounds methods DO NOT PLOT THE BREAKLINES.

TECHNICAL QUALITY CONTROL REQUIREMENTS (Concluded)

5.d. SECTION VIEWS. The sections shall be extracted and displayed from the digital terrain model (DTM OR TTN) utilizing INROADS OR INXPRESS. The sections shall be generated or extracted along the same azimuth as the section was collected in the field. The sections shall be displayed at a 10 to 1 vertical exaggeration. The planimetric lines (alignment of extraction), alignment, stations, and cross sections shall be displayed in one DGN file (NO PLOTS) with the district border file attached.

6. SURVEY/QUALITY CONTROL REPORT. The Contractor shall furnish a digital (*.doc) file on the final CD. The report shall include Right-of-Entry information, Control monuments Designation recovered, destroyed, fixed, included in control network, tide gauge location and monument used, dates of field survey collection, types of equipment used, quality control checks, and digital files. Unique circumstances and/or issues related to this survey, general approach/methodology to this survey. Along with any other data required in accordance with the law or precedent and for the Corps of Engineers to publish the results of the survey.

7. DELIVERIES. On completion, all data required shall be delivered or mailed to Design Branch, Survey Section at the address shown in contract, and shall be accompanied by a properly numbered, dated and signed letter or shipping form, in duplicate, listing the materials being transmitted. All costs of deliveries shall be borne by the Contractor. Items to be delivered include, but are not limited to the following:

7.a. GPS network plan, (before GPS work commences).

7.b. GPS raw data along with field observation log sheets filled out in field with all information and sketches.

7.c. Computation files with Horizontal and Vertical abstracts.

7.d. Horizontal and Vertical Field Books.

7.e. Furnish X, Y, Z, and descriptor ASCII file for each cross section and one merged with all data collected for all cross section.

7.f. DTM File.

7.g. DGN files.

7.h. Volumes.

7.i. Furnish a digital file using CORPSMET 95 (Metadata Software) with the appropriate data included.

7.j. Survey Report *.doc file.

D-3. Trimble Geomatics Office Data Processing

The following three screen captures (Figures D-4 a-c) from the Geomatics Office file editor show the initial calibration and control parameters set for this RTK project. Fixed positional data for ST JO 335 are also shown, along with mask angle settings, PDOP limits, instrument serial numbers, and antenna data. The site was calibrated relative to NAD 1983 (WGS 84 ellipsoid), with coordinates transformed to the Florida SPCS (East Zone). The geoid model used was GEOID 99. The elevation reference datum for this disposal area is NGVD 29.

Category	Code	Parameter	Value	Parameter	Value	Parameter	Value
HEADER	ED	Version nbr	SC V07-50	Serial nbr	5044	Date & time	13-Feb-02 20:04
JOB	NM	Job ID	010901FEB12ARC2	Pt ID Length	Alpha(14)	Include Elev	Yes
NOTE	TS	Note	Time Date 02/12/2002 T				
FEATURE FILE	FC	Feature file nam		File used	No	ID Number	00000
COGO SETTINGS	NM	Azimuth	From North	Positive Coord	North-East	Default Elev	<null>
LOC ELLIPSOID	KI	Local radius	20925604.474	Local flattening	298.2572215382		
PROJECTION	KI	Projection	Transverse Mercator	Origin Lat	24°20'00.00000"N	Origin Long	81°00'00.00000"W
DATUM	KI	Datum	Molodensky	GPS Earth radius	20925604.474	GPS Flattening [f	298.2572229329
HORZ ADJUST	KI	Origin North	<null>	Origin East	<null>	Trans North	<null>
VERT ADJUST	KI	Type	Geoid Model	Origin North	0.000	Origin East	0.000
COORD SYSTEM	NM	Option	Chosen from library	System Name	US State Plane 1983	Zone Name	Florida East 0901
GRID POS	KI	Point ID	STJO 335	Northing	2199181.300	Easting	481183.200
SURVEY	KI	Elev mask	13	PDOP mask	7.0		
SURVEY	KI	Elev mask	13	PDOP mask	6.0		
EQUIPMENT	BA	Receiver	4800	Receiver S/N	20140193	Antenna type	4800 Internal
NOTE	NM	Note	Receiver firmware versi				
SURVEY	KI	Elev mask	13	PDOP mask	6.0		
SURVEY EVENT	KI	Survey event	Base survey started				
NOTE	TS	Note	Time Date 02/12/2002 T				
EQUIPMENT	BA	Receiver	4800	Receiver S/N	20140193	Antenna type	4800 Internal
NOTE	NM	Note	Receiver firmware versi				
SURVEY	KI	Elev mask	13	PDOP mask	6.0		
SURVEY EVENT	KI	Survey event	Base survey started				
NOTE	TS	Note	Time Date 02/12/2002 T				
SURVEY	KI	Elev mask	13	PDOP mask	7.0		
SURVEY	KI	Elev mask	13	PDOP mask	6.0		
EQUIPMENT	BA	Receiver	4800	Receiver S/N	20140193	Antenna type	4800 Internal
NOTE	NM	Note	Receiver firmware versi				
SURVEY	KI	Elev mask	13	PDOP mask	6.0		
SURVEY EVENT	KI	Survey event	Base survey started				

Figure D-4a. Trimble Geomatics File Editor (Continued)

Field	Code	Description	Value	Measurement	Value	Value	Value
NOTE	TS	Note	Time Date 02/12/2002 T				
EQUIPMENT	BA	Receiver	4800	Receiver S/N	20140193	Antenna type	4800 Internal
NOTE	NM	Note	Receiver firmware versi				
GPS ANT	KI	Antenna ht	5.630	Measurement:	Uncorrected		
EQUIPMENT	BA	Receiver	4800	Receiver S/N	20140193	Antenna type	4800 Internal
NOTE	NM	Note	Receiver firmware versi				
GPS ANT	KI	Antenna ht	0.000	Measurement:	True		
GPS POS	FD	Point ID	STJO 335	WGS-84 lat	30°22'54.19958"N	WGS-84 long	81°33'17.77672"W
GPS ANT	KI	Antenna ht	5.630	Measurement:	Uncorrected		
REF STATION	BA	Ref Pt ID	STJO 335				
EQUIPMENT	NM	Receiver	4800	Receiver S/N	00009633	Antenna type	4800 Internal
NOTE	NM	Note	Receiver firmware versi				
SURVEY	KI	Elev mask	13	PDOP mask	7.0		
SURVEY EVENT	KI	Survey event	Rover survey started				
NOTE	TS	Note	Time Date 02/12/2002 T				
SURVEY	KI	Elev mask	13	PDOP mask	7.0		
SURVEY	KI	Elev mask	13	PDOP mask	6.0		
EQUIPMENT	BA	Receiver	4800	Receiver S/N	20140193	Antenna type	4800 Internal
NOTE	NM	Note	Receiver firmware versi				
SURVEY	KI	Elev mask	13	PDOP mask	6.0		
SURVEY EVENT	KI	Survey event	Base survey started				
NOTE	TS	Note	Time Date 02/12/2002 T				
EQUIPMENT	BA	Receiver	4800	Receiver S/N	20140193	Antenna type	4800 Internal
NOTE	NM	Note	Receiver firmware versi				
GPS ANT	KI	Antenna ht	0.000	Measurement:	True		
GPS POS	FD	Point ID	STJO 335	WGS-84 lat	30°22'54.19958"N	WGS-84 long	81°33'17.77672"W
GPS ANT	KI	Antenna ht	5.630	Measurement:	Uncorrected		
REF STATION	BA	Ref Pt ID	STJO 335				
EQUIPMENT	NM	Receiver	4800	Receiver S/N	00009633	Antenna type	4800 Internal
NOTE	NM	Note	Receiver firmware versi				

Figure D-4b. Trimble Geomatics File Editor (Continued)

DC File Editor - [010901FEB12ARC2]

File Edit View Tools Window Help

SURVEY	KI	Elev mask	13	PDOP mask	7.0			
SURVEY EVENT	KI	Survey event	Rover survey started					
NOTE	TS	Note	Time Date 02/12/2002					
SURVEY	KI	Elev mask	13	PDOP mask	7.0			
SURVEY	KI	Elev mask	13	PDOP mask	6.0			
EQUIPMENT	NM	Receiver	4800	Receiver S/N	00009633	Antenna type	4800 Internal	Me
NOTE	NM	Note	Receiver firmware versi					
SURVEY	KI	Elev mask	13	PDOP mask	7.0			
SURVEY EVENT	KI	Survey event	Rover survey started					
NOTE	TS	Note	Time Date 02/12/2002					
GPS ANT	KI	Antenna ht	0.000	Measurement:	True			
GPS POS	SI	Point ID	STJO 335	WGS-84 lat	30°22'54.19958"N	WGS-84 long	81°33'17.77672"W	WC
EQUIPMENT	SI	Receiver	4800	Receiver S/N	<no text>	Antenna type	4800 Internal	Me
NOTE	NM	Note	Receiver firmware versi					
GPS ANT	KI	Antenna ht	0.000	Measurement:	True			
GPS POS	FD	Point ID	STJO 335	WGS-84 lat	30°22'54.19958"N	WGS-84 long	81°33'17.77672"W	WC
GPS ANT	KI	Antenna ht	5.722	Measurement:	True			
REF STATION	KI	Ref Pt ID	STJO 335					
EQUIPMENT	NM	Receiver	4800	Receiver S/N	00009633	Antenna type	4800 Internal	Me
NOTE	NM	Note	Receiver firmware versi					
GPS ANT	KI	Antenna ht	5.900	Measurement:	Uncorrected			
INITIALIZATION	KI	Init event	Gained	GPS week	1153	GPS seconds	235670.0	Init
INITIALIZATION	KI	Init event	Lost	GPS week	1153	GPS seconds	235843.0	Init
INITIALIZATION	KI	Init event	Gained	GPS week	1153	GPS seconds	235917.0	Init
GPS VEC	TP	Point ID	3000	Delta X	563.242	Delta Y	-564.263	Del
GPS QC1	NM	Nbr of SVs (min)	6	Relative DOPs	Yes	PDOP (max)	2.5	HD
GPS QC2	NM	Nbr of SVs (min)	6	Error scale	0.0055694939	VCV xx	0.0000134088	VCV
INITIALIZATION	KI	Init event	Lost	GPS week	1153	GPS seconds	236339.0	Init
INITIALIZATION	KI	Init event	Gained	GPS week	1153	GPS seconds	236409.0	Init
GRID POS	KI	Point ID	1	Northing	2199215.870	Easting	481362.030	Ele

Start | Document1 - Microsoft Word | Exploring - Trimble Files | DC File Editor - [0109...

8:44 AM

Figure D-4c. Trimble Geomatics File Editor (Concluded)

Figure D-5 below shows the coordinates for six baseline PI points (1 through 6) along the top of the embankment.

The screenshot shows a software window titled "DC File Editor - [010901FEB12ARC2]". The main content is a table with the following data:

NOTE	TS	Note	Time Date	02/12/2002	T			
GRID POS	KI	Point ID	2	Northing	2199163.490	Easting	481671.370	Ele
GRID POS	KI	Point ID	3	Northing	2199088.920	Easting	482074.380	Ele
GRID POS	KI	Point ID	4	Northing	2199040.550	Easting	482382.000	Ele
GRID POS	KI	Point ID	5	Northing	2199029.910	Easting	482586.390	Ele
GRID POS	KI	Point ID	6	Northing	2199031.950	Easting	482826.020	Ele
NOTE	KI	Note	LINE. Name: 1, Code: BL					
NOTE	KI	Note	Start pt: 1, End pt: 2, Azi					
NOTE	KI	Note	Length: 313.743sft, Grad					
GPS VEC	TP	Point ID	3001	Delta X	176.806	Delta Y	13.595	Del
GPS QC1	NM	Nbr of SVs (min)	7	Relative DOPs	Yes	PDOP (max)	2.5	HD
GPS QC2	NM	Nbr of SVs (min)	7	Error scale	0.0042683762	VCV xx	0.0000104675	VCV
GPS VEC	TP	Point ID	3002	Delta X	177.583	Delta Y	21.728	Del
GPS QC1	NM	Nbr of SVs (min)	7	Relative DOPs	Yes	PDOP (max)	2.6	HD
GPS QC2	NM	Nbr of SVs (min)	7	Error scale	0.0057363492	VCV xx	0.0000199122	VCV
GPS VEC	TP	Point ID	3003	Delta X	177.628	Delta Y	22.944	Del
GPS QC1	NM	Nbr of SVs (min)	7	Relative DOPs	Yes	PDOP (max)	2.6	HD
GPS QC2	NM	Nbr of SVs (min)	7	Error scale	0.0049481527	VCV xx	0.0000087931	VCV
GPS VEC	TP	Point ID	3004	Delta X	178.128	Delta Y	35.977	Del
GPS QC1	NM	Nbr of SVs (min)	7	Relative DOPs	Yes	PDOP (max)	2.6	HD
GPS QC2	NM	Nbr of SVs (min)	7	Error scale	0.0035359275	VCV xx	0.0000066761	VCV
GPS VEC	TP	Point ID	3005	Delta X	177.292	Delta Y	53.941	Del
GPS QC1	NM	Nbr of SVs (min)	6	Relative DOPs	Yes	PDOP (max)	2.7	HD
GPS QC2	NM	Nbr of SVs (min)	6	Error scale	0.0066140434	VCV xx	0.0000241357	VCV
GPS VEC	TP	Point ID	3006	Delta X	178.511	Delta Y	68.680	Del
GPS QC1	NM	Nbr of SVs (min)	7	Relative DOPs	Yes	PDOP (max)	2.6	HD
GPS QC2	NM	Nbr of SVs (min)	7	Error scale	0.0067460253	VCV xx	0.0000212666	VCV
GPS VEC	TP	Point ID	3007	Delta X	178.908	Delta Y	71.723	Del
GPS QC1	NM	Nbr of SVs (min)	7	Relative DOPs	Yes	PDOP (max)	2.7	HD
GPS QC2	NM	Nbr of SVs (min)	7	Error scale	0.0051435148	VCV xx	0.000015041	VCV

The screenshot also shows a Windows taskbar at the bottom with the Start button, taskbar icons, and a system tray showing the time as 8:44 AM. The taskbar includes "Document1 - Microsoft Word", "Exploring - Trimble Files", and "DC File Editor - [0109...".

Figure D-5. Baseline PI coordinates

The following screen captures are from Trimble Geomatics "Observations" and show the first few topo observations made relative to the fixed elevation at benchmark ST JO 335. The "Geoid" window (bottom figure) depicts the (-) 93.296 ft geoid separation input for this area.

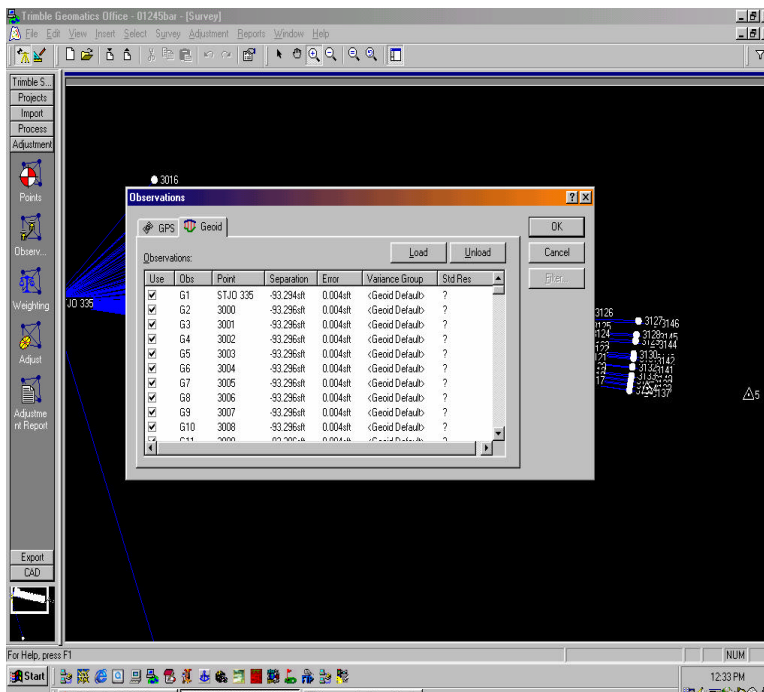
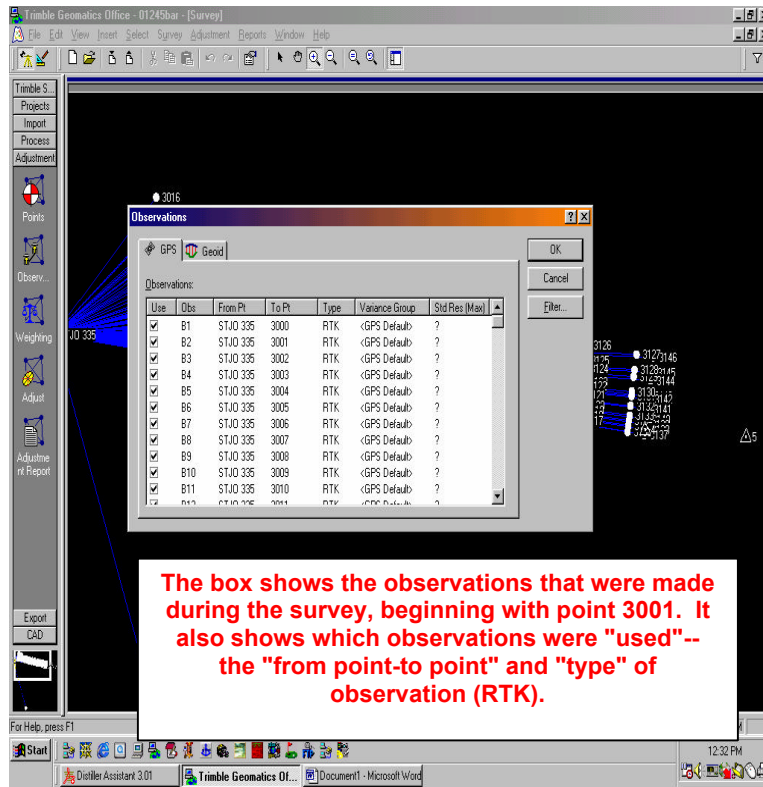

Figure D-6. Trimble Geomatics Observations windows

Weighting Strategies

GPS Geoid

Apply Scalars To:
 All Observations
 Each Observation
 Variance Groups

Scalar Type:
 Default
 Alternative
 User-defined

Scalar Value: [] Lock

Observations:

Obs	From Pt	To Pt	Next Scalar	Type	Variance Group
B1	STJO 335	3000	1.00	RTK	<GPS Default>
B2	STJO 335	3001	1.00	RTK	<GPS Default>
B3	STJO 335	3002	1.00	RTK	<GPS Default>
B4	STJO 335	3003	1.00	RTK	<GPS Default>
B5	STJO 335	3004	1.00	RTK	<GPS Default>
B6	STJO 335	3005	1.00	RTK	<GPS Default>
B7	STJO 335	3006	1.00	RTK	<GPS Default>
B8	STJO 335	3007	1.00	RTK	<GPS Default>
B9	STJO 335	3008	1.00	RTK	<GPS Default>
B10	STJO 335	3009	1.00	RTK	<GPS Default>
B11	STJO 335	3010	1.00	RTK	<GPS Default>
B12	STJO 335	3011	1.00	RTK	<GPS Default>

The box shows the weighting strategies that will be used during adjustment. The default scalar type gives the same scalar to each of the observations. If the alternative scalar type is used the scalar number will change for each of the measurements.

Weighting Strategies

GPS Geoid

Apply Scalars To:
 All Observations
 Each Observation
 Variance Groups

Scalar Type:
 Default
 Alternative
 User-defined

Scalar Value: [] Lock

Observations:

Obs	Point	Next Scalar	Separation	Error	Variance Group
G1	STJO 335	1.00	-93.294sst	0.004sst	<Geoid Default>
G2	3000	1.00	-93.296sst	0.004sst	<Geoid Default>
G3	3001	1.00	-93.296sst	0.004sst	<Geoid Default>
G4	3002	1.00	-93.296sst	0.004sst	<Geoid Default>
G5	3003	1.00	-93.296sst	0.004sst	<Geoid Default>
G6	3004	1.00	-93.296sst	0.004sst	<Geoid Default>
G7	3005	1.00	-93.296sst	0.004sst	<Geoid Default>
G8	3006	1.00	-93.296sst	0.004sst	<Geoid Default>
G9	3007	1.00	-93.296sst	0.004sst	<Geoid Default>
G10	3008	1.00	-93.296sst	0.004sst	<Geoid Default>
G11	3009	1.00	-93.296sst	0.004sst	<Geoid Default>
G12	3010	1.00	-93.296sst	0.004sst	<Geoid Default>

This box is the geoid scalar type--the default scalar is the same for each of the observations and if the alternative is used the scalar value will change for each of the observations.

Figure D-7. GPS and Geoid Weighting Strategies

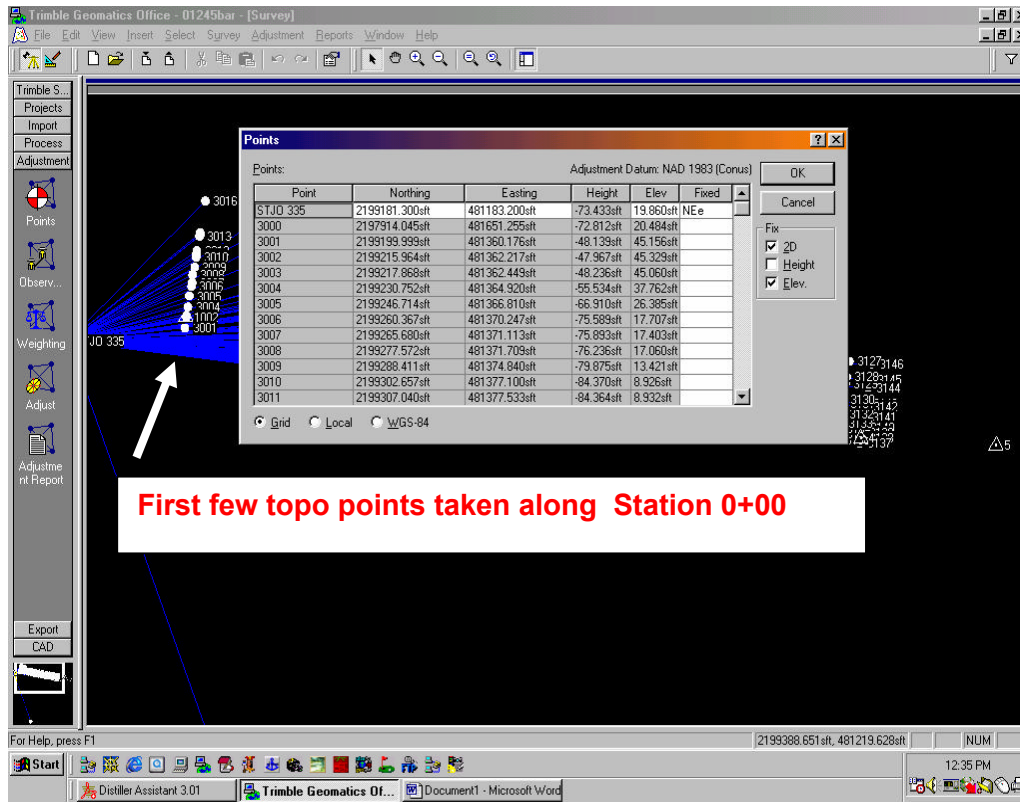

Figure D-8. Listing of first 11 topographic points in file

D-4. Final Coordinates of Points on Cross-Sections

The following Trimble tabulation lists the computed RTK coordinates and elevations for each observed point, along with information about the reference datums, geoids, grids, etc. Coordinates and elevations for the check point, ST JO 336, are also indicated. A comparison at the end of the list shows the differences between two checks on ST JO 336. This check indicated repeatability was well within 0.2 ft horizontal and 0.1 ft vertical.

Final Listing of Observed Points

Fixed width point coordinate listing

Project name 01245bar
 Coordinate Units US survey feet
 Distance Units US survey feet
 Height Units US survey feet
 Date printed 8/20/02 12:37:02 PM
 Coordinate System US State Plane 1983 Zone Florida East 0901
 Datum NAD 1983 (Conus)
 Geoid model GEOID99 (Conus)
 Coordinate units: US survey feet
 Elevation units: US survey feet

Reference Datum Parameters

Elevations referenced to NGVD 29

Point listing

Name	Northing	Easting	Elevation	Feature Code
STJO 335	2199181.300	481183.200	19.860	ACOE MON
3000	2197914.045	481651.255	20.484	CHK IN ST JO 336
1	2199215.870	481362.030	13.000	0+00
2	2199163.490	481671.370	13.000	PI 3+13.74
3	2199088.920	482074.380	13.000	PI 7+23.59
4	2199040.550	482382.000	13.000	PI 10+34.99
5	2199029.910	482586.390	13.000	PI 12+39.66
6	2199031.950	482826.020	13.000	PI 14+79.30
3001	2199199.999	481360.176	45.156	TOP LEVEE
3002	2199215.964	481362.217	45.329	GND
3003	2199217.868	481362.449	45.060	TOP LEVEE
3004	2199230.752	481364.920	37.762	SLP
3005	2199246.714	481366.810	26.385	SLP
3006	2199260.367	481370.247	17.707	TOE LEVEE
3007	2199265.680	481371.113	17.403	GND
3008	2199277.572	481371.709	17.060	BRK
3009	2199288.411	481374.840	13.421	SLP
3010	2199302.657	481377.100	8.926	BRK
3011	2199307.040	481377.533	8.932	BRK
3012	2199312.396	481378.231	10.353	BRK
3013	2199333.392	481381.984	9.018	GND
3014	2199334.741	481383.238	9.432	BRK
3015	2199338.309	481383.368	6.865	BRK SOUTH END OF PIPE PILE
3016	2199384.650	481391.055	7.821	GND NORTH SIDE OF PIPE PILE
3017	2199366.127	481488.416	7.624	GND
3018	2199347.730	481485.338	8.001	GND
3019	2199322.648	481482.309	8.471	GND
3020	2199298.067	481477.092	9.085	BRK
3021	2199272.929	481472.688	16.434	BRK
3022	2199255.697	481470.546	17.949	TOE LEVEE
3023	2199244.566	481469.000	24.264	SLP
3024	2199229.231	481465.548	35.291	SLP
3025	2199212.151	481463.286	45.550	TOP LEVEE
3026	2199197.201	481460.477	45.546	TOP LEVEE
3027	2199179.463	481558.052	45.666	TOP LEVEE
3028	2199195.180	481560.957	45.681	TOP LEVEE
3029	2199212.564	481564.767	33.632	SLP
3030	2199226.977	481567.093	23.017	SLP
3031	2199235.011	481567.707	17.555	TOE LEVEE
3032	2199258.442	481572.385	15.941	BRK
3033	2199281.314	481575.366	10.959	GND
3034	2199274.564	481676.546	9.443	TREE LINE
3035	2199264.474	481674.632	9.502	GND
3036	2199248.182	481671.606	10.271	BRK
3037	2199245.983	481671.930	12.527	BRK

LINE 1

PI
Station
0+00

Points
3001
thru
3016

Final Listing of Observed Points (Continued)

Name	Northing	Easting	Elevation	Feature Code
3038	2199240.352	481670.583	16.606	BRK
3039	2199239.973	481670.826	16.597	BRK
3040	2199216.180	481666.760	17.168	TOE LEVEE
3041	2199210.533	481664.537	20.202	SLP
3042	2199195.746	481662.326	30.564	SLP
3043	2199180.980	481660.209	41.257	SLP
3044	2199173.701	481659.481	45.693	TOP LEVEE
3045	2199159.847	481656.740	45.862	TOP LEVEE
3046	2199157.651	481669.736	45.861	TOP LEVEE
3047	2199164.029	481671.527	45.971	GND
3048	2199172.385	481673.051	45.648	TOP LEVEE
3049	2199178.972	481673.282	40.667	SLP
3050	2199193.732	481676.922	30.838	SLP
3051	2199208.133	481679.138	20.259	SLP
3052	2199213.831	481680.182	17.037	TOE LEVEE
3053	2199237.524	481684.628	16.738	BRK
3054	2199244.599	481685.769	10.463	BRK
3055	2199271.059	481689.628	9.106	TREE LINE
3056	2199248.677	481775.660	8.129	TREE LINE
3057	2199227.998	481770.512	9.607	BRK
3058	2199220.781	481769.121	15.875	BRK
3059	2199199.758	481765.024	16.842	TOE LEVEE
3060	2199192.327	481763.747	19.992	SLP
3061	2199177.703	481761.018	29.702	SLP
3062	2199163.207	481758.872	39.776	SLP
3063	2199154.511	481757.891	45.578	TOP LEVEE
3064	2199147.475	481755.512	45.729	GND
3065	2199140.021	481755.480	45.570	TOP LEVEE
3066	2199120.937	481852.586	45.105	TOP LEVEE
3067	2199130.060	481854.090	45.132	GND
3068	2199136.808	481856.432	44.989	TOP LEVEE
3069	2199144.995	481857.716	39.716	SLP
3070	2199159.413	481859.993	29.485	SLP
3071	2199174.480	481863.265	20.065	SLP
3072	2199181.776	481865.501	16.948	TOE LEVEE
3073	2199201.096	481868.135	15.688	BRK
3074	2199206.059	481868.126	8.690	BRK
3075	2199231.069	481873.669	7.121	TREE LINE
3076	2199103.740	481950.915	45.295	TREE LINE
3077	2199103.646	481951.690	45.260	TOP LEVEE
3078	2199112.366	481952.925	45.417	GND
3079	2199117.876	481954.391	45.049	TOP LEVEE
3080	2199126.659	481956.372	40.023	SLP
3081	2199141.430	481959.148	29.481	SLP
3082	2199156.118	481960.785	20.228	SLP
3083	2199162.793	481962.528	16.679	TOE LEVEE
3084	2199182.459	481965.633	15.532	BRK
3085	2199188.883	481966.505	8.357	BRK
3086	2199211.685	481971.859	5.488	TREE LINE
3087	2199196.029	482070.755	6.406	TREE LINE
3088	2199173.846	482065.692	7.875	BRK
3089	2199165.071	482065.076	16.162	BRK
3090	2199143.318	482059.769	17.537	TOE LEVEE
3091	2199137.896	482058.831	20.323	SLP
3092	2199123.031	482056.113	29.447	SLP
3093	2199108.614	482053.986	39.740	SLP
3094	2199100.852	482051.997	45.151	TOP LEVEE
3095	2199093.674	482050.679	45.279	GND
3096	2199086.315	482049.134	45.579	TOP LEVEE
3097	2199081.124	482073.545	45.330	TOP LEVEE
3098	2199089.674	482075.034	45.414	GND

Final Listing of Observed Points (Concluded)

Name	Northing	Easting	Elevation	Feature Code
3099	2199097.527	482076.386	44.784	TOP LEVEE
3100	2199104.299	482077.444	40.172	SLP
3101	2199118.692	482080.383	29.698	SLP
3102	2199133.761	482083.402	20.255	SLP
3103	2199138.783	482084.389	17.650	TOE LEVEE
3104	2199160.505	482088.277	16.597	BRK
3105	2199168.850	482089.607	8.810	BRK
3106	2199192.889	482092.993	5.844	TREE LINE
3107	2199182.573	482165.848	6.137	TREE LINE
3108	2199156.945	482162.124	8.130	BRK
3109	2199147.118	482161.417	16.249	BRK
3110	2199127.248	482157.412	17.403	TOE LEVEE
3111	2199121.910	482156.701	19.962	SLP
3112	2199106.873	482154.575	29.773	SLP
3113	2199092.500	482151.611	40.207	SLP
3114	2199084.389	482150.513	45.505	TOP LEVEE
3115	2199077.070	482148.916	45.605	GND
3116	2199069.835	482147.937	45.346	TOP LEVEE
3117	2199053.593	482248.233	45.445	TOP LEVEE
3118	2199061.015	482249.129	45.489	GND
3119	2199068.622	482250.452	45.438	TOP LEVEE
3120	2199076.630	482251.368	39.882	SLP
3121	2199091.695	482253.717	29.251	SLP
3122	2199106.298	482256.417	20.293	SLP
3123	2199111.368	482257.035	17.799	TOE LEVEE
3124	2199131.742	482259.561	16.689	BRK
3125	2199142.707	482261.077	7.581	BRK
3126	2199166.334	482264.746	4.956	GND
3127	2199151.877	482364.498	5.293	GND
3128	2199129.007	482360.224	7.096	BRK
3129	2199119.051	482358.557	16.268	BRK
3130	2199097.092	482354.914	17.644	TOE LEVEE
3131	2199090.754	482354.390	19.786	SLP
3132	2199075.847	482352.131	29.372	SLP
3133	2199061.315	482350.750	39.630	SLP
3134	2199053.703	482348.875	45.246	TOP LEVEE
3135	2199046.268	482347.542	45.743	GND
3136	2199037.454	482346.208	45.410	TOP LEVEE
3137	2199032.359	482380.200	45.147	TOP LEVEE
3138	2199041.159	482382.638	45.704	GND
3139	2199048.788	482383.667	45.587	TOP LEVEE
3140	2199055.931	482385.236	40.246	SLP
3141	2199070.519	482387.084	30.297	SLP
3142	2199085.384	482388.779	20.138	SLP
3143	2199090.871	482389.763	17.801	TOE LEVEE
3144	2199113.683	482393.186	16.724	BRK
3145	2199125.318	482394.590	7.227	BRK
3146	2199147.958	482398.202	5.426	GND
3147	2197914.192	481651.189	20.539	CHK IN ST JO 336

ST JO 336 checks: Points 3000 & 3147
dx = +0.147 ft
dy = -0.066 ft
dz = +0.055 ft

Appendix E

Application: Photogrammetric Mapping Control Surveys of Nine Mile Run (Pittsburgh District)

The following report of a photo control survey was submitted by TERRASURV, a contractor to the Pittsburgh District. It summarizes GPS observations performed to establish control for a photogrammetric mapping project.

REPORT OF SURVEY NINE MILE RUN PITTSBURGH, PA

INTRODUCTION

TERRASURV was requested to perform a geodetic control survey covering a portion of the Nine Mile Run watershed in Pittsburgh, Allegheny County, Pennsylvania. The purpose of the survey was to provide control values (photo identities) for use in photogrammetric mapping of an area around Nine Mile Run between the Monongahela River to the south and Forbes Avenue to the North.

In addition, three pairs of intervisible monuments were to be established for use in future survey work in the project area. This phase of the project was observed and adjusted separately from the photo control.

The work was performed as a subcontractor to GRW, Inc. (client) who was contracted by the Pittsburgh District of the US Army Corps of Engineers (contracting agency).

CONTROL

The contracting agency requested that the horizontal component of the control be referenced to the North American Datum of 1983, 1986 adjustment (NAD 1983 1986), and that the vertical component of the control be referenced to the National Geodetic Vertical Datum of 1929 (NGVD 1929).

The horizontal control consisted of two National Spatial Reference System (NSRS) stations located along the Monongahela River. Station **7002** (PID# KX2402) is a City of Pittsburgh City Line disk in a monument box at the now abandoned Amoco Refinery, on the left bank of the Monongahela River at river mile 5.75, just west of the mouth of Streets Run and the Glenwood Bridge. Station **L/D 2 M 6** (PID# KX2396) is a USACE survey disk on the right bank land wall at Lock and Dam 2, at the lower lock gates. Both of these stations were part of the USACE Monongahela River GPS network done in 1989. They are first order horizontal and second order class I vertical control.

The vertical control consisted of the two stations used for horizontal control, and station **IVY** (PID# KX1251). This is a USACE harbor line monument located along the rail line on the right bank of the river, approximately 165 m upstream of the upstream edge of the railroad bridge over Nine Mile Run, in the Duck Hollow section of Pittsburgh. This station has a vertical accuracy of first order class I.

In 1988, a Second-Order level run was made starting at **3041** (PID# KX1478) and **3042** (PID# KX1479), both of which are first order class II benchmarks. This level line, run with a Wild NA-2 with micrometer

and Inver rods, ran along the perimeter of this project, and ended at **IVY**. The line closed +0.000 m, and was computed on the NGVD 1929 datum. Several elevations determined in the 1988 run were used in the current project. Ties were made at the following stations: 00028I, 00028K, 00028N, and 00028U.

In addition to the requested datums, horizontal positions were also computed on the North American Datum of 1927 (NAD 1927), utilizing the USACE river control, and on the North American Datum of 1986, 1996 adjustment (NAD 1983 1996), utilizing the Continuously Operating Reference Station (CORS) PIT1. The elevations were computed on the North American Vertical Datum of 1988 (NAVD 1988) as well.

PHOTO CONTROL STATIONS

The locations of the photo identities were selected by GRW. The following is a list of the photo control points:

name	GPSID	description
101	00028A	C/L sidewalk @ west end of street
102	00028B	NW corner of walk at end
103	00028C	NW edge of street @ c/l narrow sidewalk
104	00028D	NW corner of drive @ S edge of street
105H1	00028E ECC	base of pole
105H2	00028E ECC	Post
105H3	00028E ECC	Milepost
105V1	00028E ECC	C/L tracks opposite signal box
105V2	00028E ECC	C/L tracks opposite milepost
106	00028F	SW corner of drive
107	00028G	SW corner of drive @ N edge of road
108H	00028H ECC	base of pole
109	00028I	NW corner of pavement
110H	00028J ECC	base of lone tree
110V1	00028J ECC	C/L road opposite tree
110V2	00028J ECC	C/L road X C/L trail
111	00028K	center of CB grate on N side of street
112	00028L	NW corner of pavement
113H	00028M ECC	Base of northernmost goal post
114	00028N	edge of pavement at end of stop bar
115	00028O	C/L sidewalk X C/L sidewalk
116	00028P	NW corner of sidewalk intersection
117	00028Q	C/L manhole
118	00028R	N edge of sidewalk @ C/L sidewalk
119	00028S	NW corner of sidewalk @ N edge of drive
120	00028T	NE corner of parking pavement
121	00028U	C/L manhole
122	00028V	center of CB grate on N side of street

Note that additional identities were selected at several of the stations (105 & 110). At 105, the pole selected was located on a steep bank, and therefore additional horizontal and vertical identities were surveyed along the railroad tracks. At 110, additional vertical identities (coordinated) were surveyed.

The short eccentrics at 108 and 113 were done with a compass (corrected for declination) and tape. The longer offsets at 110 and 105 were done using a Zeiss S10 total station, utilizing distant intersection stations for orientation.

MONUMENTS

Three monument pairs were established in locations that would be useful for conventional surveying. The following is a description of these stations:

00028AA: located at the fishing area at the bottom of Old Browns Hill Road, in the Duck Hollow Section of the City of Pittsburgh, on the right bank of the Monongahela River. It is a disk on a concrete structure, 15.25 m SW of a triangular metal structure near the SE corner of the parking area, 0.67 m landward of the river wall. Intervisible with 00028AB. “DUCK HOLLOW”

00028AB: located on an access bridge to an old water intake station at the former USX Homestead Works in Homestead, in what is now a new development, behind the Eat N Park headquarters building (under construction), on the left bank of the Monongahela River. The disk is 15.81 m N of the NE corner of the building, 0.805 m north (riverward) of the south end of the access bridge, and 0.545 m E of the E face of the W curb of the bridge. Intervisible with 00028AA. “EAT N PARK”

00028AC: To reach, take Beechwood Boulevard east from Browns Hill Road to the entrance to Rosemont (new subdivision). Travel to the end of the cul-de-sac, and walk out to the edge of the hill, past the air monitor station. The station is a disk in a concrete monument in the cleared area around the edge of the hill, 10.464 m from three punch marks in a fence corner post at the air monitor station, and 0.5 m back from the edge. Intervisible with 00028AD. “ROSEMONT”

00028AD: located in a clearing off of Commercial Street, now reachable only from Whipple Street in Swissvale due to a road closure. There is a boarded up construction trailer to the SE, and the station is near the guardrail. The station is a disk in a concrete monument, 7.085 from a PK in a utility pole, and 10.472 m from a punch mark in the top of a guardrail post. Intervisible with 00028AC. “COMMERCIAL”

00028AE: located on a traffic island between Forbes Avenue and Beechwood Boulevard, near the entrance to Homewood Cemetery. The station is an existing disk cemented in the concrete island, stamped 226 AZIMUTH MON VALLEY EXP. Intervisible with 00028AF. “BEECHWOOD”

00028AF: located on the back wall of a catch basin on the north side of Forbes Avenue, near a small gas utility building. The disk is 0.52 m east of the east edge of the building extended, 5.57 m from the corner, 0.119 m north of the south face of curb on the north side of Forbes, also 2.88 m south of the south face of a stone wall. Intervisible with 00028AE. “FORBES”

Four of the six stations have additional backsight objects. A steel standpipe (WTVENT) located atop a hill near the Monongahela Cemetery, straddling the Braddock and Braddock Hills boundary was intersected from EAT N PARK, DUCK HOLLOW, and ROSEMONT. The point sighted was the small vent rising from the center of the roof of the tank. A barrel like object (HAZELMICRO) atop a radio tower just west of Calvary Cemetery in the Glenwood section of the City of Pittsburgh was intersected from ROSEMONT and DUCK HOLLOW. Both of these intersection stations were previously coordinated during an electronic traverse along the Monongahela River for sounding control. Station

EM 1110-1-1003**1 Jul 03**

BEECHWOOD is an existing azimuth mark set in 1988 during mapping of the proposed Monongahela Valley Expressway. The main station MV226 was tied by angle and distance measurements. All of these additional measurements were included in the adjustment, as were the EDM and zenith distances between the stations of each monument pair. [Sketches of these stations are included in Appendix A--withdrawn.]

GPS OBSERVATIONS

The project was observed in two phases. The photo control was done on days 099 and 101 of 2000. The following is a summary of the station occupations:

Day 099 (three receivers):

<u>Station</u>	<u>Filename</u>	<u>UTC Start</u>	<u>UTC End</u>	<u>Duration</u>
00028C	97570990.DAT	12:38:00	13:00:45	23 min
00028B	17690990.DAT	12:44:00	13:00:30	17 min
00028A	99810990.DAT	12:51:00	13:22:15	31 min
00028G	97570991.DAT	13:12:15	13:59:15	47 min
00028D	17690990.DAT	13:13:00	13:22:00	9 min
00028H	17690990.DAT	13:41:00	14:00:00	19 min
00028I	99810991.DAT	13:42:00	14:53:30	72 min
00028V	17690990.DAT	14:19:30	15:30:00	71 min
00028J	97570992.DAT	14:24:30	14:45:15	21 min
00028K	97570993.DAT	15:10:30	15:30:15	20 min
00028R	99810992.DAT	15:13:15	16:08:00	55 min
00028Q	97570994.DAT	15:39:45	16:07:30	28 min
00028S	17690990.DAT	15:47:30	16:46:15	59 min
00028T	97570995.DAT	16:16:45	16:46:15	30 min
00028U	99810993.DAT	16:29:45	17:15:00	45 min
00028O	17690991.DAT	16:58:15	17:14:15	16 min
00028O	17690992.DAT	18:17:30	18:47:00	30 min
00028N	9757099B.DAT	18:20:00	18:47:00	27 min
00028F	99810994.DAT	18:27:00	18:47:15	20 min
00028T	9757099C.DAT	18:55:45	19:32:15	37 min
00028P	17690992.DAT	19:05:00	19:32:15	27 min
00028M	99810995.DAT	19:16:00	20:30:15	74 min
00028H	17690992.DAT	19:41:15	20:30:00	49 min
00028L	9757099D.DAT	19:55:15	20:30:30	35 min
00028F	99810996.DAT	20:51:15	21:28:30	37 min
00028C	17690992.DAT	20:55:15	21:46:00	51 min
00028E	9757099E.DAT	21:11:00	21:28:15	17 min
KX1251	9957099F.DAT	21:36:45	21:46:00	9 min

Day 101 (two receivers):

<u>Station</u>	<u>Filename</u>	<u>UTC Start</u>	<u>UTC End</u>	<u>Duration</u>
00028N	97571010.DAT	11:47:00	12:14:30	28 min
KX2396	99811011.DAT	13:43:45	18:30:15	287 min
KX1251	97571011.DAT	14:08:30	14:26:45	18 min
KX2402	97571012.DAT	18:06:45	19:34:30	88 min
00028R	99811010.DAT	18:54:00	19:08:15	14 min

The monument control was done on day 228 using two receivers:

<u>Station</u>	<u>Filename</u>	<u>UTC Start</u>	<u>UTC End</u>	<u>Duration</u>
KX1251	99812280.DAT	17:00:00	17:37:30	38 min
00028AA	97572280.DAT	17:00:30	18:31:30	91 min
00028AB	99812281.DAT	17:48:30	18:05:00	17 min
00028AC	99812282.DAT	18:16:30	18:31:00	15 min
00028AD	99812283.DAT	18:50:00	19:52:15	62 min
00028AC	97572281.DAT	18:51:30	19:20:00	29 min
00028AB	97572282.DAT	19:36:00	19:53:45	18 min
00028AC	97572283.DAT	20:06:15	20:35:00	29 min
00028AE	99812284.DAT	20:08:15	21:29:45	82 min
00028AF	97572284.DAT	20:55:30	22:15:30	80 min
00028AD	99812285.DAT	21:51:00	22:17:15	26 min

No equipment or other problems were encountered during the observations.

GPS DATA PROCESSING

The GPS data was downloaded to a PC and processed using the GPSurvey WAVE processor, version 2.35. The single baseline method was used. Most of the baselines in the network independent (i.e. non-trivial), but several of the “trivial” baselines from day 099 were included. These lines are not totally non-trivial, due to differing start and stop times. The broadcast ephemeris was used. The following is a summary of the baseline processing for the photo control network:

FILENAME	FROM	TO	DATE	TIME	DUR	RATIO	VAR	RMS	LENGTH
00063958	00028A	00028B	04/08/00	12:51	10	14.81	4.25	0.006	625 m
00063962	00028A	00028C	04/08/00	12:51	10	12.00	8.68	0.009	788 m
00063966	00028B	00028C	04/08/00	12:44	17	67.14	6.89	0.008	613 m
00064010	00028C	00028E	04/08/00	21:11	17	9.66	17.56	0.016	611 m
00064014	00028C	00028F	04/08/00	20:55	33	13.75	6.57	0.008	914 m
00064006	00028C	KX1251	04/08/00	21:36	9	75.64	2.37	0.005	59 m
00063954	00028D	00028A	04/08/00	13:13	9	10.92	4.34	0.007	867 m
00064018	00028F	00028E	04/08/00	21:11	17	10.08	13.62	0.015	539 m
00063946	00028G	00028A	04/08/00	13:12	10	10.01	4.24	0.006	1319 m
00063950	00028G	00028D	04/08/00	13:13	9	18.94	2.56	0.005	588 m
00063942	00028H	00028G	04/08/00	13:41	18	20.14	16.93	0.017	721 m
00063998	00028H	00028L	04/08/00	19:55	35	3.86	38.11	0.023	975 m
00063886	00028I	00028G	04/08/00	13:42	17	13.30	2.64	0.005	852 m
00063894	00028I	00028H	04/08/00	13:42	18	20.62	18.28	0.017	744 m
00063882	00028I	00028J	04/08/00	14:24	21	22.80	1.96	0.005	610 m
00063890	00028I	00028V	04/08/00	14:19	34	11.85	3.79	0.006	1051 m
00063898	00028J	00028V	04/08/00	14:24	21	10.24	6.23	0.008	819 m
00063910	00028K	00028R	04/08/00	15:13	17	10.86	3.53	0.006	463 m
00063990	00028M	00028H	04/08/00	19:41	49	10.68	23.96	0.018	704 m
00063982	00028M	00028L	04/08/00	19:55	35	3.66	18.00	0.014	562 m
00063994	00028M	00028P	04/08/00	19:16	16	9.06	9.01	0.009	578 m
00063986	00028M	00028T	04/08/00	19:16	16	15.06	2.33	0.006	912 m
00063978	00028N	00028F	04/08/00	18:27	20	12.02	8.98	0.011	555 m
00063970	00028O	00028F	04/08/00	18:27	20	1.71	71.39	0.025	1092 m
00063974	00028O	00028N	04/08/00	18:20	27	1.89	112.63	0.031	537 m
00064046	00028O	00028N	04/10/00	11:49	26	12.28	7.56	0.009	537 m
00064002	00028P	00028T	04/08/00	19:05	27	4.49	6.83	0.009	454 m
00063922	00028Q	00028S	04/08/00	15:47	20	5.08	12.44	0.011	589 m
00063914	00028R	00028Q	04/08/00	15:39	28	11.11	6.65	0.009	893 m
00063918	00028R	00028S	04/08/00	15:47	21	5.84	9.99	0.011	1087 m
00063930	00028S	00028T	04/08/00	16:16	30	4.05	9.48	0.010	460 m
00063926	00028S	00028U	04/08/00	16:29	17	3.41	11.93	0.012	1096 m
00063934	00028T	00028U	04/08/00	16:29	17	11.03	3.22	0.006	671 m
00063938	00028U	00028O	04/08/00	16:58	16	12.41	5.29	0.008	593 m
00063906	00028V	00028K	04/08/00	15:10	20	8.45	6.59	0.009	708 m
00063902	00028V	00028R	04/08/00	15:13	17	11.21	5.10	0.007	1159 m
00064038	KX2396	KX1251	04/10/00	14:08	18	9.14	1.79	0.014	5247 m
00064034	KX2396	KX2402	04/10/00	18:06	24	14.36	1.19	0.011	6692 m
00064042	KX2402	00028R	04/10/00	18:54	14	11.33	2.15	0.016	6177 m

The two baselines denoted above in **bold** type were rejected.

EM 1110-1-1003
1 Jul 03

The data from the CORS station PIT1 was obtained and processed using the data from day 099. The following summarizes these results:

00063870	pit1	00028A	04/08/00	12:51	31	8.97	5.17	0.027	24515 m
00063846	pit1	00028C	04/08/00	20:55	51	25.94	1.56	0.015	23730 m
00063830	pit1	00028F	04/08/00	20:51	37	13.56	2.48	0.016	22824 m
00063866	pit1	00028G	04/08/00	13:12	47	4.97	5.15	0.024	23316 m
00063850	pit1	00028H	04/08/00	19:41	49	6.99	4.86	0.025	22598 m
00063862	pit1	00028I	04/08/00	13:42	72	4.72	1.19	0.012	22788 m
00063834	pit1	00028L	04/08/00	19:55	35	*****	21.97	0.049	21633 m
00063838	pit1	00028M	04/08/00	19:16	74	7.70	3.44	0.021	21971 m
00063858	pit1	00028R	04/08/00	15:13	55	29.63	0.99	0.010	20781 m
00063874	pit1	00028S	04/08/00	15:47	59	1.74	8.12	0.031	20915 m
00063842	pit1	00028T	04/08/00	18:55	37	27.28	0.95	0.010	21302 m
00063854	pit1	00028U	04/08/00	16:29	45	10.26	2.13	0.017	21633 m
00063878	pit1	00028V	04/08/00	14:19	71	7.79	2.00	0.016	21795 m

Of the thirteen baselines processed from PIT1, four (in **bold** type) were rejected. The other nine were included in the adjustment.

The monument network was observed on day 228. The following is a summary of these results:

FILENAME	FROM	TO	DATE	TIME	DUR	RATIO	VAR	RMS	LENGTH
00087929	00028AA	00028AC	08/15/00	18:16	15	14.96	5.14	0.007	929 m
00087945	00028AE	00028AC	08/15/00	20:08	27	7.09	11.19	0.012	1721 m
00087925	00028AA	00028AB	08/15/00	17:48	17	17.34	16.50	0.013	356 m
00087941	00028AF	00028AD	08/15/00	21:51	25	6.90	11.71	0.012	1506 m
00087921	00028AA	KX1251	08/15/00	17:00	37	15.39	5.83	0.007	265 m
00087957	00028AD	00028AB	08/15/00	19:36	16	13.38	3.20	0.007	1459 m
00087937	00028AE	00028AF	08/15/00	20:55	34	3.18	18.07	0.016	379 m
00087953	00028AD	00028AC	08/15/00	18:51	29	21.29	1.91	0.005	728 m
00087933	pit1	00028AE	08/15/00	20:08	82	6.62	2.57	0.017	22116 m
00087949	pit1	00028AD	08/15/00	18:50	62	13.09	1.86	0.015	22533 m
00087917	pit1	00028AA	08/15/00	17:00	91	12.65	2.63	0.019	23976 m

All of these results were acceptable.

LEAST SQUARES ADJUSTMENTS

GEOLAB was used to perform all of the various adjustments. No scaling of the *a priori* baseline statistics was done. Geoid heights were interpolated for each station using the GEOID99 model. Station errors (HI and centering) of 0.005 m were input for the GPS observations.

The first adjustment was a free adjustment of the GPS only portion of the photo control network (i.e. no traverse or eccentric observations). A map of this network is shown in figure 1. Station **7002** was held fixed in all three dimensions (NAD 1983 1986 latitude and longitude, NGVD 1929 orthometric height). The estimated variance factor was 1.18. The plot in figure 2 shows the horizontal and vertical residuals versus baseline length for this adjustment. The misclosures at the other control stations were as follows:

Station Name	Azimuth	Distance	Δ Height
00028I			+0.009 m
00028K			+0.036 m
00028N			+0.019 m
00028U			+0.002 m
KX1251			+0.001 m
KX2396	319 \emptyset	0.037 m	+0.011 m

As can be seen, the misclosures are all within the expected range. The output from this adjustment is included in appendix B.

The next adjustment added the traverse and eccentric information to the network, vertically constrained the four new stations with elevations, and constrained in all three dimensions the two existing NSRS stations, **7002** and **L/D 2 M 6**. This adjustment had an estimated variance factor of 1.70. The output from this adjustment is included in appendix C. The coordinates from this adjustment were provided to the client to be used as photo control for aerotriangulation.

The monument network was surveyed as a network with a tie to **IVY** and **PIT1**. The coordinate for **IVY** resulting from the photo control network was constrained in a free adjustment. The network is shown in figure 3. This adjustment had an estimated variance factor of 1.31. A level tie from BEECHWOOD to a nearby TBM from the 1988 survey had a vertical misclosure of 0.008 m. A subsequent adjustment was performed that constrained **IVY** in all three dimensions, and BEECHWOOD (00028AE) vertically. This adjustment had an estimated variance factor of 1.27. This adjustment supplied the coordinates for the monuments, and the output is included in appendix D. The plot in figure 4 shows the horizontal and vertical residuals versus baseline length for this adjustment.

Although not requested by the contracting agency, adjustments were also performed on the NAD 1983 1992 horizontal datum and NAVD 1988 vertical datum, as well as the NAD 1927 horizontal datum.

A free adjustment was run holding the NAD 1983 1996 coordinates of PIT1 fixed, as well as the GPS derived NAVD 1988 orthometric height of PIT1. This adjustment included all of the GPS observations from both the photo control network and the monument network, as well as the traverse observations and eccentric measurements. The estimated variance factor was 1.14. The misclosure at the other control stations were as follows:

<u>Station</u>	<u>Azimuth</u>	<u>Distance</u>	<u>Δ Height</u>
KX1251			+0.018 m
KX2396	51ø	0.102 m	+0.021 m
KX2402	51ø	0.108 m	+0.007 m

The vertical misclosures are excellent. The horizontal misclosures show a bias of approximately 10 cm. This is common in Pennsylvania, and results from the poor ties between the HARN/CORS network and the existing NSRS network. Although the two Monongahela River GPS Network stations were established using GPS, they were controlled by triangulation stations. The ties between the existing triangulation network and the HARN/CORS are very sparse. Because of this, these two stations were not constrained horizontally in the subsequent constrained adjustment.

A constrained NAD 1983 1992/NAVD 1988 adjustment was done that held PIT1 fixed in all three dimensions, and KX1251, KX2396, and KX2402 fixed vertically. The coordinates from this adjustment are listed below.

A final adjustment held the two Monongahela River GPS network stations fixed horizontally on NAD 1927. The horizontal coordinates from this adjustment are also given below.

SUMMARY

A geodetic control network was established in Allegheny County, Pennsylvania for the purpose of photogrammetric mapping of a portion of the Nine Mile Run watershed. The relative accuracy of the network is first order (10 ppm). The absolute accuracy of the network on NAD 1983 1992/NAVD 1988 is ± 0.03 m, and ± 0.05 m on NAD 1983 1986/NGVD 1929.

Figure 1 - Photo Control network

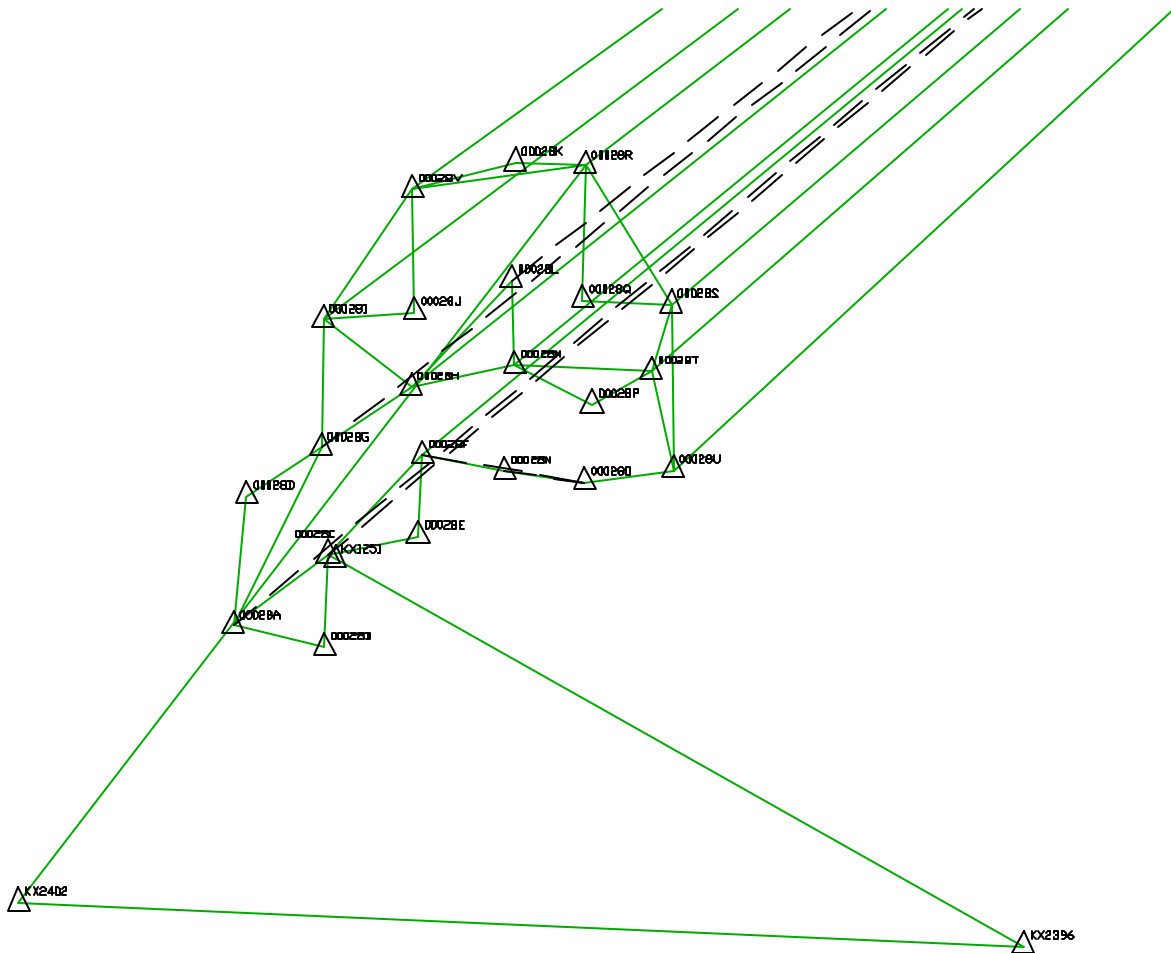

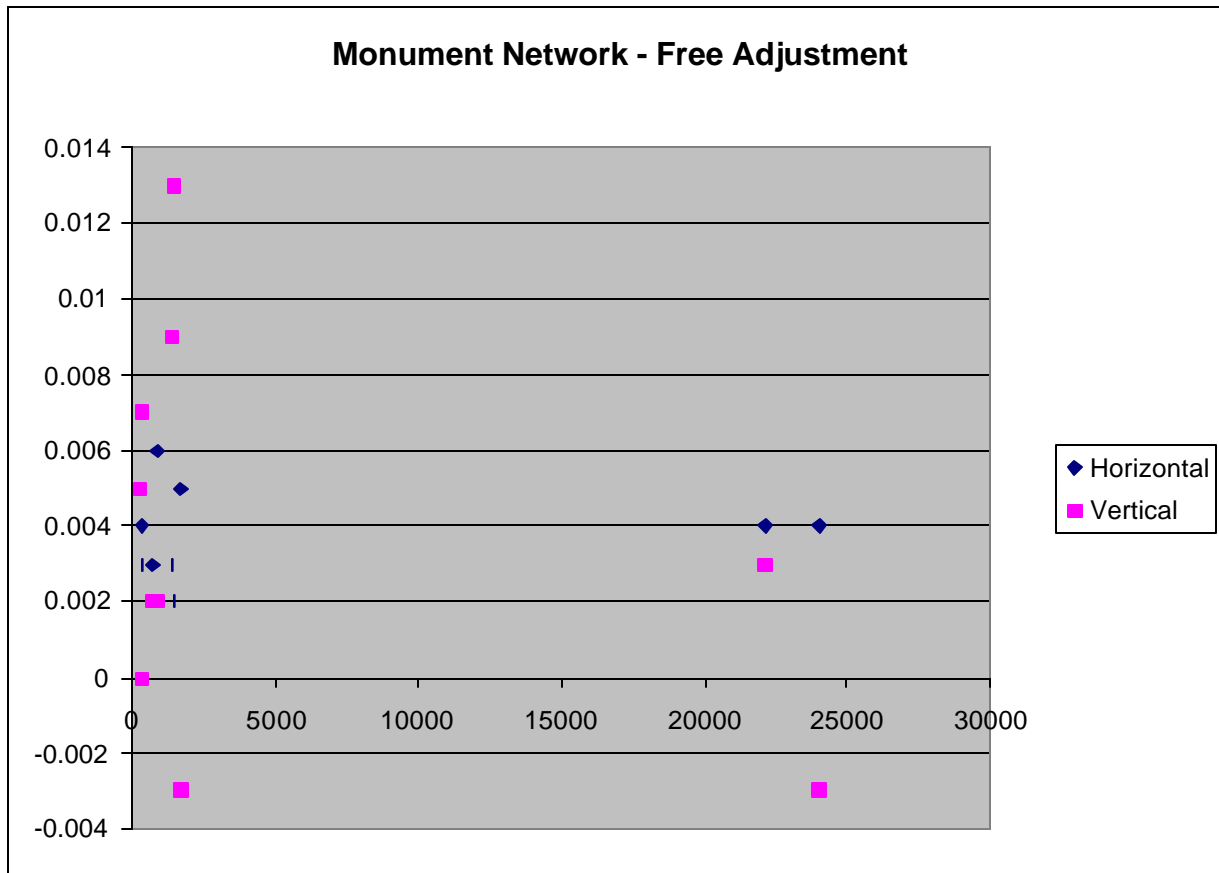

Figure 4 - Free Adjustment Residuals Monument Network

**EM 1110-1-1003
1 Jul 03**

Geographic Coordinates – NAD 1983 1986/NGVD 1929 meters

Station name	DD.MSSSSSSS	DD.MSSSSSSS	NGVD 29
00028A	+40.244373915	-79.551903928	279.471
00028B	+40.243892060	-79.545337681	226.404
00028C	+40.245877823	-79.545212383	226.078
00028D	+40.251161627	-79.551470183	314.363
00028E	+40.250258950	-79.542669843	229.274
00028F	+40.251994846	-79.542509201	272.652
00028G	+40.252182038	-79.545361428	313.808
00028H	+40.253459240	-79.542806129	266.139
00028I	+40.254941105	-79.545272706	345.491
00028J	+40.255069893	-79.542692187	335.031
00028K	+40.262266917	-79.535783977	287.435
00028L	+40.255732751	-79.535935253	244.717
00028M	+40.253912794	-79.535880664	234.322
00028N	+40.251625186	-79.540203241	276.056
00028O	+40.251371439	-79.533948213	269.077
00028P	+40.253038314	-79.533713726	260.288
00028Q	+40.255286358	-79.533933278	274.932
00028R	+40.262180888	-79.533823209	277.638
00028S	+40.255164744	-79.531439207	278.031
00028T	+40.253742651	-79.532020712	265.289
00028U	+40.251612166	-79.531451814	284.970
00028V	+40.261721597	-79.542700963	305.088
105H1	+40.250285773	-79.542675087	231.017
105H2	+40.250294316	-79.542491782	228.181
105H3	+40.250231666	-79.542982566	228.664
105V1	+40.250283909	-79.542478089	229.083
105V2	+40.250217640	-79.542979675	229.565
108H	+40.253460079	-79.542807586	266.139
110H	+40.255111069	-79.542734712	335.930
110V1	+40.255089174	-79.542728131	335.547
110V2	+40.255091557	-79.542710634	335.478
113H	+40.253911904	-79.535881363	234.322
KX1251	+40.245775546	-79.545001015	228.411
KX2396	+40.233266491	-79.513732815	223.342
KX2402	+40.234468037	-79.562064720	222.229
PIT1	+40.330373303	-79.415003350	387.967
WM TANK	+40.220215201	-79.552106762	
00028AA	+40.245218145	-79.545853741	222.236
00028AB	+40.244629080	-79.544553760	227.315
00028AC	+40.252095183	-79.544753173	307.386
00028AD	+40.252889612	-79.541862393	236.118
00028AE	+40.261662630	-79.544304435	319.725
00028AF	+40.261723257	-79.542698290	305.243
HAZELMICRO	+40.244148128	-79.555545080	
MV226	+40.261346816	-79.543230087	329.615
TBM	+40.252128376	-79.544885781	307.083
WTVENT	+40.244605636	-79.513177261	

PA South Zone State Plane Coordinates – NAD 1983 1986 US Survey FT.

Station name	Northing	Easting
00028A	400435.8779	1363757.9807
00028B	399899.6831	1365730.4180
00028C	401906.1722	1365876.5568
00028D	403247.7692	1364162.7121
00028E	402243.6187	1367851.9233
00028F	403996.6802	1368019.0322
00028G	404240.0212	1365818.4710
00028H	405483.7251	1367825.6717
00028I	407029.5104	1365955.4943
00028J	407110.9705	1367953.5743
00028K	410290.3802	1370280.5208
00028L	407729.5595	1370101.1665
00028M	405887.3896	1370098.5408
00028N	403579.2282	1369792.7885
00028O	403280.1225	1371530.0718
00028P	404961.9994	1371752.3144
00028Q	407240.3361	1371637.8055
00028R	410166.5011	1371793.9987
00028S	407070.5582	1373562.8761
00028T	405642.7933	1373078.4837
00028U	403476.8521	1373466.1279
00028V	409793.7040	1368012.3367
105H1	402270.8526	1367848.5345
105H2	402276.0323	1367990.4748
105H3	402221.9265	1367609.4503
105V1	402265.2456	1368000.8108
105V2	402207.6827	1367611.3381
108H	405484.6017	1367824.5637
110	407153.4294	1367921.7141
110V1	407131.1552	1367926.2594
110V2	407133.2352	1367939.8470
113H	405886.5022	1370097.9778
KX1251	401798.6993	1366037.4568
KX2396	392829.9184	1380730.4457
KX2402	394578.9939	1358845.9242
PIT1	449561.1714	1427433.1207
WM TANK	384093.1350	1363198.9126
00028AA	401250.9819	1365364.2711
00028AB	400630.4221	1366354.8731
00028AC	404140.6297	1366286.5849
00028AD	404889.6479	1368541.2109
00028AE	409764.3684	1366771.4392
00028AF	409795.3329	1368014.4416
HAZELMICRO	400276.8881	1360936.7527
MV226	409424.5584	1367594.0708
TBM	404176.7208	1366184.8803
WTVENT	400244.2779	1381337.4967

EM 1110-1-1003
1 Jul 03

Geographic Coordinates – NAD 1983 1992/NAVD 1988 meters

Station name	DD.MMS\$sssss	DD.MMS\$sssss	NAVD 88	Ellip H
00028A	+40.244373923	-79.551902931	279.315	245.654
00028AA	+40.245218164	-79.545852750	222.103	188.444
00028AB	+40.244629097	-79.544552771	227.185	193.532
00028AC	+40.252095199	-79.544752183	307.258	273.593
00028AD	+40.252889624	-79.541861400	235.994	202.335
00028AE	+40.261662646	-79.544303440	319.598	285.919
00028AF	+40.261723272	-79.542697296	305.118	271.444
00028B	+40.243892070	-79.545336685	226.250	192.598
00028C	+40.245877835	-79.545211390	225.925	192.266
00028D	+40.251161633	-79.551469183	314.206	280.536
00028E	+40.250258960	-79.542668847	229.121	195.468
00028F	+40.251994853	-79.542508202	272.499	238.841
00028G	+40.252182043	-79.545360426	313.649	279.982
00028H	+40.253459242	-79.542805124	265.979	232.316
00028I	+40.254941106	-79.545271700	345.330	311.656
00028J	+40.255069893	-79.542691179	334.873	301.206
00028K	+40.262266913	-79.535782970	287.299	253.633
00028L	+40.255732752	-79.535934247	244.556	210.895
00028M	+40.253912795	-79.535879658	234.160	200.504
00028N	+40.251625191	-79.540202241	275.910	242.260
00028O	+40.251371440	-79.533947208	268.920	235.278
00028P	+40.253038315	-79.533712719	260.126	226.479
00028Q	+40.255286352	-79.533932265	274.775	241.122
00028R	+40.262180880	-79.533822193	277.483	243.823
00028S	+40.255164742	-79.531438197	277.870	244.226
00028T	+40.253742652	-79.532019705	265.127	231.484
00028U	+40.251612168	-79.531450811	284.802	251.168
00028V	+40.261721595	-79.542699953	304.933	271.258
105H1	+40.250285783	-79.542674089	230.864	197.211
105H2	+40.250294319	-79.542490783	228.028	194.375
105H3	+40.250231689	-79.542981571	228.511	194.857
105V1	+40.250283911	-79.542477091	228.930	195.278
105V2	+40.250217662	-79.542978681	229.412	195.758
108H	+40.253460081	-79.542806581	265.979	232.316
110	+40.255111070	-79.542733702	335.772	302.105
110V1	+40.255089174	-79.542727122	335.388	301.721
110V2	+40.255091557	-79.542709625	335.319	301.652
113H	+40.253911906	-79.535880357	234.160	200.504
HAZELMICRO	+40.244148158	-79.555544088		
KX1251	+40.245775573	-79.545000039	228.262	194.604
KX2396	+40.233266541	-79.513731866	223.196	189.625
KX2402	+40.234468007	-79.562063673	222.065	188.411
MV226	+40.261346832	-79.543229093	329.488	295.813
PIT1	+40.330373303	-79.415002340	387.807	354.289
TBM	+40.252128392	-79.544884790	306.955	273.290
WM TANK	+40.220215201	-79.552106762		
WTVENT	+40.244605614	-79.513176210		

PA South Zone State Plane Coordinates – NAD 1983 1992 US Survey FT.

Station name	Northing	Easting
00028A	400435.8671	1363758.7464
00028AA	401250.9826	1365365.0372
00028AB	400630.4205	1366355.6389
00028AC	404140.6270	1366287.3509
00028AD	404889.6413	1368541.9767
00028AE	409764.3658	1366772.2050
00028AF	409795.3293	1368015.2149
00028B	399899.6742	1365731.1916
00028C	401906.1656	1365877.3226
00028D	403247.7565	1364163.4854
00028E	402243.6098	1367852.6966
00028F	403996.6683	1368019.8055
00028G	404240.0074	1365819.2443
00028H	405483.7083	1367826.4446
00028I	407029.4927	1365956.2673
00028J	407110.9515	1367954.3552
00028K	410290.3575	1370281.2937
00028L	407729.5415	1370101.9473
00028M	405887.3716	1370099.3217
00028N	403579.2145	1369793.5618
00028O	403280.1045	1371530.8526
00028P	404961.9814	1371753.0953
00028Q	407240.3111	1371638.5860
00028R	410166.4742	1371794.7792
00028S	407070.5372	1373563.6566
00028T	405642.7753	1373079.2645
00028U	403476.8357	1373466.9012
00028V	409793.6830	1368013.1175
105H1	402270.8440	1367849.3081
105H2	402276.0166	1367991.2481
105H3	402221.9311	1367610.2164
105V1	402265.2289	1368001.5762
105V2	402207.6864	1367612.1042
108H	405484.5847	1367825.3367
110	407153.4114	1367922.4950
110V1	407131.1362	1367927.0402
110V2	407133.2162	1367940.6278
113H	405886.4854	1370098.7587
HAZELMICRO	400276.8992	1360937.5267
KX1251	401798.7082	1366038.2153
KX2396	392829.9515	1380731.1816
KX2402	394578.9434	1358846.7356
MV226	409424.5558	1367594.8365
PIT1	449561.1540	1427433.8999
TBM	404176.7185	1366185.6464
WM TANK	384093.1350	1363198.9126
WTVENT	400244.2362	1381338.3080

EM 1110-1-1003
1 Jul 03

Geographic Coordinates – NAD 1927

Station name	DD.MSSSSSSS	DD.MSSSSSSS
00028A	+40.244349603	-79.551986513
00028AA	+40.245193860	-79.545936409
00028AB	+40.244604788	-79.544636468
00028AC	+40.252070927	-79.544835873
00028AD	+40.252865366	-79.541945187
00028AE	+40.261638437	-79.544387157
00028AF	+40.261699067	-79.542781066
00028B	+40.243867751	-79.545420358
00028C	+40.245853542	-79.545295081
00028D	+40.251137345	-79.551552780
00028E	+40.250234673	-79.542752613
00028F	+40.251970585	-79.542591969
00028G	+40.252157768	-79.545444089
00028H	+40.253434984	-79.542888866
00028I	+40.254916860	-79.545355361
00028J	+40.255045651	-79.542774919
00028K	+40.262242708	-79.535866797
00028L	+40.255708526	-79.540018090
00028M	+40.253888547	-79.535963495
00028N	+40.251600920	-79.540286074
00028O	+40.251347169	-79.534031107
00028P	+40.253014061	-79.533796623
00028Q	+40.255262116	-79.534016143
00028R	+40.262156675	-79.533906073
00028S	+40.255140513	-79.531522168
00028T	+40.253718409	-79.532103665
00028U	+40.251587902	-79.531534782
00028V	+40.261697382	-79.542783695
105H1	+40.250261496	-79.542757856
105H2	+40.250270033	-79.542574556
105H3	+40.250207401	-79.543065327
105V1	+40.250259625	-79.542560864
105V2	+40.250193374	-79.543062438
108H	+40.253435823	-79.542890323
110	+40.255086827	-79.542817443
110V1	+40.255064931	-79.542810862
110V2	+40.255067315	-79.542793365
113H	+40.253887658	-79.535964195
HAZELMICRO	+40.244123813	-79.555627636
KX1251	+40.245751293	-79.545083789
KX2396	+40.233242234	-79.513816333
KX2402	+40.234443553	-79.562146844
MV226	+40.261322620	-79.543312845
PIT1	+40.330349718	-79.415088725
TBM	+40.252104121	-79.544968476
WM TANK	+40.220190200	-79.552189000
WTVENT	+40.244581371	-79.513261026

PA South Zone State Plane Coordinates – NAD 1927 US Survey FT.

Station name	Northing	Easting
00028A	400405.9895	1395177.4664
00028AA	401221.1024	1396783.7489
00028AB	400600.5429	1397774.3460
00028AC	404110.7278	1397706.0624
00028AD	404859.7368	1399960.6822
00028AE	409734.4341	1398190.9246
00028AF	409765.3976	1399433.9228
00028B	399869.8009	1397149.8958
00028C	401876.2845	1397296.0189
00028D	403217.8625	1395582.2064
00028E	402213.7231	1399271.3860
00028F	403966.7708	1399438.5104
00028G	404210.1046	1397237.9665
00028H	405453.7960	1399245.1626
00028I	406999.5715	1397374.9981
00028J	407081.0273	1399373.0791
00028K	410260.4098	1401700.0258
00028L	407699.6170	1401520.6469
00028M	405857.4556	1401518.0256
00028N	403549.3152	1401212.2607
00028O	403250.2053	1402949.5450
00028P	404932.0703	1403171.7890
00028Q	407210.3798	1403057.3036
00028R	410136.5242	1403213.5064
00028S	407040.6104	1404982.3575
00028T	405612.8600	1404497.9573
00028U	403446.9322	1404885.5930
00028V	409763.7428	1399431.8480
105H1	402240.9570	1399267.9976
105H2	402246.1298	1399409.9415
105H3	402192.0443	1399028.9147
105V1	402235.3425	1399420.2699
105V2	402177.7999	1399030.8025
108H	405454.6723	1399244.0544
110	407123.4853	1399341.2182
110V1	407101.2107	1399345.7638
110V2	407103.2917	1399359.3514
113H	405856.5695	1401517.4626
HAZELMICRO	400247.0088	1392356.1915
KX1251	401768.8424	1397456.8696
KX2396	392800.1691	1412149.6687
KX2402	394549.0396	1390265.6255
MV226	409394.6244	1399013.5473
PIT1	449531.0097	1458852.3085
TBM	404146.8199	1397604.3628
WM TANK	384062.8217	1394618.6122
WTVENT	400214.3974	1412756.5621

Appendix F

Application: Static GPS Control Survey--Coyote Dam, Russian River, CA (Sacramento District)

This appendix provides an example of a static GPS surveys performed on a Corps civil works project performed during 1989. This survey was performed prior to full operational capability of the GPS satellite constellation; thus, observation windows had to be observed in order to obtain four or more satellites. The procedures and standards that were used for performing, reducing, and adjusting these early GPS surveys have not significantly changed, other than the more user-friendly field data collection devices and significantly updated Windows-based baseline reduction and adjustment software. Baseline reduction and adjustment software techniques shown on these 1989 surveys are still representative of the current reductions and analyses performed today--only the output formats have changes.

F-1. Planning Phase

The GPS survey was planned for 25 April 1989 in the vicinity of Coyote Dam on the East Fork of the Russian River, near Ukiah, California.

a. A diagram of the project area is shown in Figure F-1. Three fixed control points were connected--Calpella 1949, Perry 1949, and Ukiah Airport 1949.

b. Four Trimble 4000 SL GPS carrier phase tracking receivers were used for the survey--with one person per receiver. In actuality, because the personnel were inexperienced in conducting a GPS survey, a fifth person was also used. The fifth person was used as a "runner" who can be called upon during the survey to aid in smoothing out any complications (e.g., aiding in overall communication and coordination, parts retrieval in case of breakdown, bad power source, blown fuse, misplaced equipment, forgotten measurement device or power cord, as well as any other possible complication). Communication between personnel was by two-way radio. Care was taken in choosing and operating the two-way radio near the GPS survey so that the radio transmitter and receiver chosen, when in operation, would not interfere with the GPS receiver.

c. Prior to data collection, the stations were inspected and found to be acceptable (easy accessibility, no obstruction or possible multipath sources, and at least 20 degree satellite visibility above the horizon).

d. April 25, 1989 corresponds to Julian calendar day 115. Calpella, Perry, and Ukiah Airport were stations with established horizontal control. Pier 1 and Pier 2 were stations requiring horizontal coordinates accurate to 1:10,000 (refer to Figure F-2). Therefore, the following station conventions for Session 1 of the survey were:

Pier 1 - Station 20011151
Pier 2 - Station 20021151
Calpella - Station 20131151
Ukiah Airport - Station 20141151

It is important to note that this station convention was used for this survey because the Trimble receiver only allowed numeric input of station names. Newer receivers allow alphanumeric inputs for station names, which provides more flexibility in station naming.

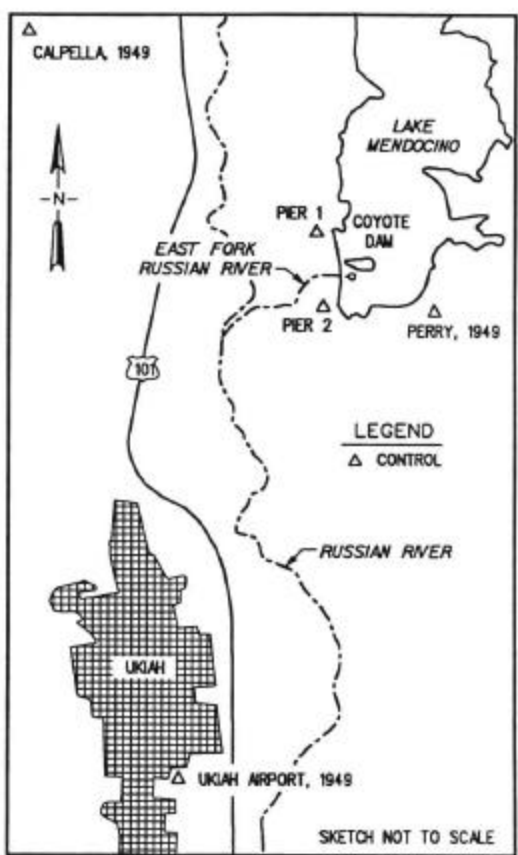

Figure F-1. Ukiah Project Area

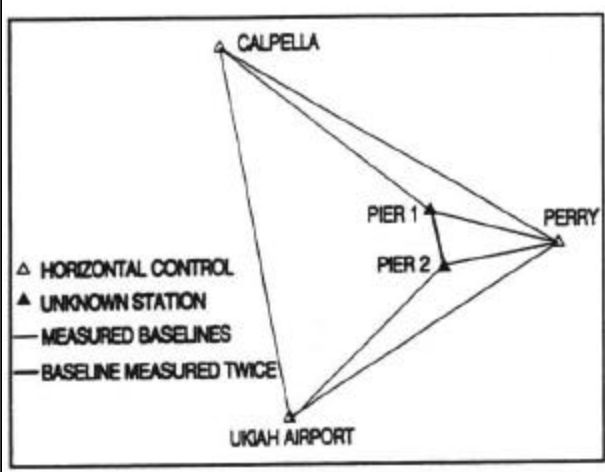

Figure F-2. GPS Project Diagram (Ukiah)

e. A satellite visibility plan (a software package that produces a hard copy listing of satellite constellations and time availability based on ephemerides) was run for the project location. The satellite visibility was run with the most up-to-date ephemeris for the period of observation, using four-satellite visibility, and with a cut-off elevation angle of 20 deg. An up-to-date ephemeris was used to ensure the satellite visibility formulated was the most accurate. A minimum of 4 visible satellites was specified in order to formulate accurate three-dimensional solutions. A cut-off elevation of 20 deg was chosen in order to minimize any diffusion or dispersion of the signal by the atmosphere which in turn may cause errors in the solution as the satellites pass near the horizon. The satellite visibility plan produced for the Ukiah project is shown below.

All-In-View PDOP for UKIAH

Date : 25 Feb 1990	Time : 4:00 -> 4:00				
Latitude : 39° 12' 30" N	Longitude : 123° 10' 30" W				
Cut-off Elevation : 20	Zone : - 7:00				
	Time	Time		PDOP	
Satellite Constellation	Rise	Set	dT	Rise	Set
6 9 11 13	21:55	22:03	0:08	4.9	5.0
6 9 11 12 13	22:02	22:33	0:30	3.8	3.6
6 9 11 12 13 19	22:32	23:18	0:45	3.2	3.3
3 6 9 11 12 13 19	23:17	23:48	0:30	2.9	3.0
3 9 11 12 13 19	23:47	1:08	1:20	4.2	4.2
3 11 12 13 19	1:07	1:22	0:15	4.9	5.0
3 12 13 19	1:22	2:20	0:58	22.7	31.6

The portion of the satellite visibility where the PDOP is near 5.0 m/m or below are times when the satellite geometry is conducive for conduct of a survey. A PDOP near or below 5.0 m/m does not guarantee a successful survey but it does indicate good satellite geometry during that moment of the survey--see Chapter 5 for further information on PDOP.

f. From the satellite visibility plan, it was decided to conduct three sessions during the survey. Travel between survey sites, time to set up and take down the equipment before and after the survey, receiver warm up time, time of survey (at least an hour allotment for survey data collection, but more than an hour if at all possible), and possible time loss due to unforeseeable problems or complications were taken into account before deciding on a specific session schedule. The final survey session schedule is shown in the chart below:

Final Survey Session Schedule

Session	Start Time	Stop Time
1	21:55	22:55
2	23:38	00:38
3	01:23	02:20

It was further decided which stations would be occupied during each session. Station occupation was designed to minimize travel time and to add to the overall efficiency of the survey. The station occupation schedule was planned as shown in the following chart:

Station Occupation Schedule

Session	Station	Station	Station	Station
1	Calpella	Ukiah Airport	Pier 1	Pier 2
2	Calpella	Perry	Pier 1	Pier 2
3	Ukiah Airport	Perry	Pier 1	Pier 2

g. A GPS Station Observation Log is generally filled out prior to conduct of the survey. An example of a GPS Station Observation Log is shown in Figure F-3. The GPS Station Observation Log must be filled out for each of the station occupied in order to have a written record of the actual survey and as an aid for the personnel occupying each of the station.

h. Portions of the GPS Station Observation Log were filled out prior to data collection. These portions included the station name, start date, GPS 8 character ID for each session, project name, project location, observer name, approximate receiver position (latitude, longitude, and elevation), session scheduled start and stop times, and requisite tracking equipment information. In this case, six GPS Station Observation Logs were filled out, one each for: Calpella (Sessions 1 & 2), Ukiah Airport (Session 3), Ukiah Airport (Session 1), Perry (Sessions 1 & 2), Pier 1 (Sessions 1, 2, and 3), and Pier 2 (Sessions 1, 2, and 3). An example of a GPS Station Observation Log for Station "Pier 2" is shown in Figure F-4.

U.S. ARMY CORPS OF ENGINEERS
GPS DATA LOGGING SHEET

PROJECT NAME _____ LOCALITY _____
 OBSERVER _____ AGENCY/FIRM _____
 RECEIVER _____ S/N _____
 ANTENNA _____ S/N _____
 DATA RECORDING UNIT _____ S/N _____
 TRIBRACH _____ S/N _____ LAST CALIBRATED: _____

	SESSION 1		SESSION 2		SESSION 3	
STATION: NAME	_____	_____	_____	_____	_____	_____
NUMBER	_____	_____	_____	_____	_____	_____
DAY OF YEAR	_____	_____	_____	_____	_____	_____
DATE MM DD YY	_____	_____	_____	_____	_____	_____
UTC TIME OF OBSERVATION	START	STOP	START	STOP	START	STOP

ANTENNA HEIGHT MEASUREMENTS

	SESSION 1		SESSION 2		SESSION 3	
SLOPE @ BEGINNING	_____ IN= _____ M	_____ IN= _____ M	_____ IN= _____ M	_____ IN= _____ M	_____ IN= _____ M	_____ IN= _____ M
	MN = _____ M	MN = _____ M	MN = _____ M	MN = _____ M	MN = _____ M	MN = _____ M
SLOPE @ END	_____ IN= _____ M	_____ IN= _____ M	_____ IN= _____ M	_____ IN= _____ M	_____ IN= _____ M	_____ IN= _____ M
	MN = _____ M	MN = _____ M	MN = _____ M	MN = _____ M	MN = _____ M	MN = _____ M
MN ADJ TO VERT:	_____ M	_____ M	_____ M	_____ M	_____ M	_____ M

	PROGRAMMED FIELD		PROGRAMMED FIELD		PROGRAMMED FIELD	
	REFPOS	POSITION	REFPOS	POSITION	REFPOS	POSITION
LAT	_____	_____	_____	_____	_____	_____
LONG	_____	_____	_____	_____	_____	_____
HT	_____	_____	_____	_____	_____	_____
PDOP	_____	_____	_____	_____	_____	_____
SVS TO TRACK LOCAL	_____	_____	_____	_____	_____	_____
TIME: SCHEDULED	_____	_____	_____	_____	_____	_____
ACTUAL	_____	_____	_____	_____	_____	_____
START	_____	_____	_____	_____	_____	_____
STOP	_____	_____	_____	_____	_____	_____

PAGE 1

a. Front

Figure F-3 a. Example GPS Station Observation Log (Front)

U.S. ARMY CORPS OF ENGINEERS
GPS DATA LOGGING SHEET

	SESSION 1	SESSION 2	SESSION 3
ANT CABLE LENGTH	_____	_____	_____
POWER SUPPLY	_____	_____	_____
WEATHER CONDITIONS	_____ _____	_____ _____	_____ _____
MONUMENT TYPE	_____	_____	_____
EXACT STAMPING	_____	_____	_____
AGENCY CAST IN DISK	_____	_____	_____

SESSION 1	SKETCH OF SITE SESSSION 2	SESSION 3

Describe any abnormalities and/or problems encountered during the survey, include session number, time of occurence and duration.

PAGE 2

b. Back

Figure F-3 b. Example GPS Station Observation Log (Back)

U.S. ARMY CORPS OF ENGINEERS
GPS DATA LOGGING SHEET

PROJECT NAME COYOTE DAM LOCALITY UKIAH, CA
 OBSERVER LARRY LAMB AGENCY/FIRM COE, SACRAMENTO DISTRICT
 RECEIVER TRIMBLE 4000 SL S/N 2820A00223
 ANTENNA TRIMBLE MICRO SL S/N 2816A00224
 DATA RECORDING UNIT RECEIVER S/N 2820A00224
 TRIBRACH WILD GDF 22 S/N N/A LAST CALIBRATED: 4/24/89

	SESSION 1	SESSION 2	SESSION 3
STATION: NAME	<u>PIER 2</u>	<u>PIER 2</u>	<u>PIER 2</u>
NUMBER	<u>2002</u>	<u>2002</u>	<u>2002</u>
DAY OF YEAR	<u>115</u>	<u>115</u>	<u>115</u>
DATE MM DD YY	<u>4/25/89</u>	<u>4/25/89</u>	<u>4/25/89</u>
UTC TIME OF OBSERVATION	START <u>04:56</u> STOP <u>05:55</u>	START <u>06:10</u> STOP <u>07:38</u>	START <u>07:55</u> STOP <u>09:20</u>

ANTENNA HEIGHT MEASUREMENTS

	SESSION 1	SESSION 2	SESSION 3
SLOPE @ BEGINNING	IN= _____ M MN = _____ M	IN= _____ M MN = _____ M	IN= _____ M MN = _____ M
SLOPE @ END	IN= _____ M MN = _____ M	IN= _____ M MN = _____ M	IN= _____ M MN = _____ M
MN ADJ TO VERT:	_____ M	_____ M	_____ M

	PROGRAMMED REFPOS	FIELD POSITION	PROGRAMMED REFPOS	FIELD POSITION	PROGRAMMED REFPOS	FIELD POSITION
LAT	<u>39-12-30</u>	_____	<u>39-12-30</u>	_____	<u>39-12-30</u>	_____
LONG	<u>123-10-30</u>	_____	<u>123-10-30</u>	_____	<u>123-10-30</u>	_____
HT	<u>244.0</u>	_____	<u>244.0</u>	_____	<u>244.0</u>	_____
PDOP	<u>3.6</u>	_____	<u>4.8</u>	_____	<u>4.0</u>	_____
SVS TO TRACK LOCAL	<u>02,03,06,09</u> <u>11,12,13,14</u>	_____	<u>02,03,06,09</u> <u>11,12,13,14</u>	_____	<u>03,06,09,11</u> <u>12,13,14,16</u>	_____
TIME: SCHEDULED	_____	_____	_____	_____	_____	_____
START	<u>21:55</u>	_____	<u>23:38</u>	_____	<u>01:20</u>	_____
STOP	<u>22:55</u>	_____	<u>00:38</u>	_____	<u>02:20</u>	_____

PAGE 1

a. Front

Figure F-4. GPS Station Observation Log (Pre-Survey)

F-2. Actual Survey Operation

Those portions of the GPS Station Observation Log, which were not filled out during the planning phase of the survey, were filled out during data collection. An example of the GPS Station Observation Log for Station "Pier 2", filled out after data collection, is shown in Figure F-5.

a. Key to proper data collection is correct set up of the equipment (tripod, receiver, and power source) and correct antenna height measurements (height of the antenna above the mark).

b. Figure F-6 shows personnel correctly taking an antenna height measurement over a temporary monument. Figure F-7 illustrates a typical antenna setup with the following equation detailing the antenna height correction.

$$v = \text{sqrt} [s^2 - r^2]$$

where

v = corrected vertical height distance of the antenna center above the mark,

s = slope distance measurement derived from the average of several antenna height measurements

r = antenna radius

c. When measuring the antenna height during this survey, the following procedure was followed in order to ensure an accurate reading:

(1) The slope distance from the North point of the antenna to the center of the monument was measured to the nearest millimeter (0.001 m). Measurement was also done in English units (inches) to the nearest 1/32th of an inch. This value then was compared to the metric value measured earlier. This comparison is done to detect blunders.

(2) Similar measurements are also taken from the South point of the antenna to the center of the monument.

(3) The resultant North and South slope distances were averaged.

(4) Example: (Refer to Figure F-5)

- Tripod set up flat on a dock.
- The North side measure up for session 1 = .120m
- The South side measure up for session 1 = .120m
- An extra "Check Measurement" was also taken for the measure up for Session 1 and was found to = 0.394 ft.
- As a check: (0.394 ft.) x (1m / 3.281 ft.) = .120m
- This value was recorded in the GPS Station Observation Log.

d. Each GPS receiver was operated in direct accordance with the manufacturer instructions, procedures, and/or guidance.

e. No problems were encountered during the survey sessions.

U.S. ARMY CORPS OF ENGINEERS
GPS DATA LOGGING SHEET

PROJECT NAME COYOTE DAM LOCALITY UKIAH, CA
 OBSERVER LARRY LAMB AGENCY/FIRM COE SACRAMENTO DISTRICT
 RECEIVER TRIMBLE 4000SL S/N 2820A00223
 ANTENNA TRIMBLE 5800SL S/N 2816A00224
 DATA RECORDING UNIT RECEIVER S/N 2820A00224
 TRIBRACH WILD GDF 22 S/N N/A LAST CALIBRATED: 4/24/89

	SESSION 1	SESSION 2	SESSION 3
STATION: NAME	<u>PIER 2</u>	<u>PIER 2</u>	<u>PIER 2</u>
NUMBER	<u>2002</u>	<u>2002</u>	<u>2002</u>
DAY OF YEAR	<u>115</u>	<u>115</u>	<u>115</u>
DATE MM DD YY	<u>4/25/89</u>	<u>4/25/89</u>	<u>4/25/89</u>
UTC TIME OF OBSERVATION	START <u>04:56</u> STOP <u>05:55</u>	START <u>06:10</u> STOP <u>07:38</u>	START <u>07:55</u> STOP <u>09:20</u>

ANTENNA HEIGHT MEASUREMENTS

	SESSION 1	SESSION 2	SESSION 3
SLOPE @ BEGINNING	<u>0.120</u> <u>0.120</u> <u>0.120</u> <u>4¹³/₁₆</u> IN = <u>0.121</u> M MN = <u>0.120</u> M	<u>0.116</u> <u>0.116</u> <u>0.116</u> <u>4⁹/₁₆</u> IN = <u>0.116</u> M MN = <u>0.116</u> M	<u>0.123</u> <u>0.124</u> <u>0.124</u> <u>4¹³/₁₆</u> IN = <u>0.124</u> M MN = <u>0.1238</u> M
SLOPE @ END	<u>4⁸/₁₆</u> <u>4¹²/₁₆</u> <u>4¹⁴/₁₆</u> <u>0.120</u> IN = <u>4¹³/₁₆</u> M MN = <u>0.120</u> M	<u>4⁹/₁₆</u> <u>4⁹/₁₆</u> <u>4⁹/₁₆</u> <u>0.116</u> IN = <u>4⁹/₁₆</u> M MN = <u>0.116</u> M	<u>4¹³/₁₆</u> <u>4¹⁴/₁₆</u> <u>4¹⁴/₁₆</u> <u>0.123</u> IN = <u>4¹³/₁₆</u> M MN = <u>0.1230</u> M
MN ADJ TO VERT:	<u>0.120</u> M	<u>0.116</u> M	<u>0.1234</u> M

	PROGRAMMED REFPOS	FIELD POSITION	PROGRAMMED REFPOS	FIELD POSITION	PROGRAMMED REFPOS	FIELD POSITION
LAT	<u>39-12-30</u>	<u>39-12-22.64</u>	<u>39-12-30</u>	<u>39-12-22.48</u>	<u>39-12-30</u>	<u>39-12-22.81</u>
LONG	<u>123-10-30</u>	<u>123-10-33.42</u>	<u>123-10-30</u>	<u>123-10-33.20</u>	<u>123-10-30</u>	<u>123-10-33.62</u>
HT	<u>244.0</u>	<u>210.6</u>	<u>244.0</u>	<u>199.8</u>	<u>244.0</u>	<u>222.8</u>
PDOP	<u>3.6</u>	<u>-</u>	<u>4.8</u>	<u>-</u>	<u>4.0</u>	<u>-</u>
SVS TO TRACK LOCAL	<u>02,03,06,09</u> <u>11,12,13,14</u>	<u>02,03,06,09</u> <u>11,12,13,14</u>	<u>03,06,09,11</u> <u>12,13,14,16</u>			
TIME: SCHEDULED	<u>21:55</u>	<u>23:38</u>	<u>01:20</u>			
ACTUAL	<u>21:56</u>	<u>23:10</u>	<u>00:55</u>			
STOP	<u>22:55</u>	<u>20:38</u>	<u>02:20</u>			
	<u>22:55</u>	<u>00:38</u>	<u>02:20</u>			

PAGE 1

a. Front

Figure F-5a. GPS Observation Log (Post-Survey)

U.S. ARMY CORPS OF ENGINEERS
GPS DATA LOGGING SHEET

	SESSION 1	SESSION 2	SESSION 3
ANT CABLE LENGTH	<u>100 ft</u>	<u>100 ft</u>	<u>35 ft</u>
POWER SUPPLY	<u>12V DC</u>	<u>12V DC</u>	<u>12V DC</u>
WEATHER CONDITIONS	<u>CLEAR, COOL</u> <u>45°</u>	<u>CLEAR, COOL</u> <u>40°</u>	<u>CLEAR, COOL</u> <u>40°</u>
MONUMENT TYPE	<u>"C" (SET IN PIER)</u>	<u>← SAME</u>	<u>← SAME</u>
EXACT STAMPING	<u>PIER 2 1953</u>	<u>← "</u>	<u>← "</u>
AGENCY CAST IN DISK	<u>COE</u>	<u>← "</u>	<u>← "</u>

SESSION 1	SKETCH OF SITE SESSION 2	SESSION 3
	<p>← SAME</p>	<p>← SAME</p>

Describe any abnormalities and/or problems encountered during the survey, include session number, time of occurrence and duration.

THE ANTENNA WAS MOUNTED DIRECTLY OVER PIER 2 WITH NO TRIPOD USED.
ANTENNA HEIGHT WAS MEASURED VERTICALLY FROM GROUND PLANE TO BRASS DISK.

PAGE 2

b. Back

Figure F-5b. GPS Observation Log (Post-Survey)

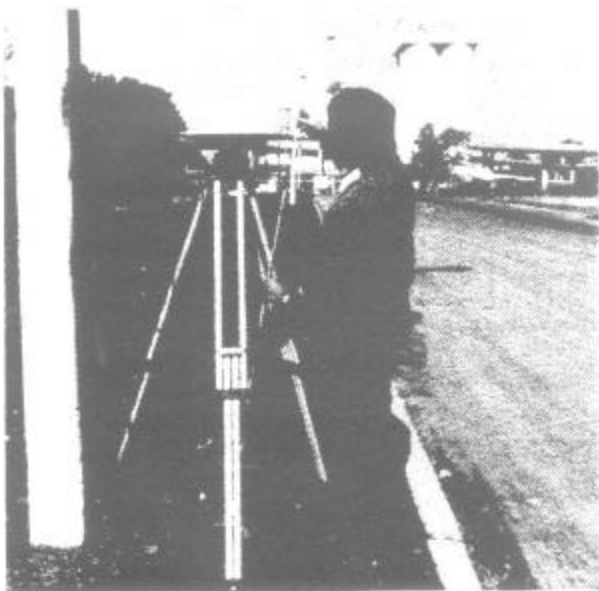

Figure F-6. Antenna Height Measurement

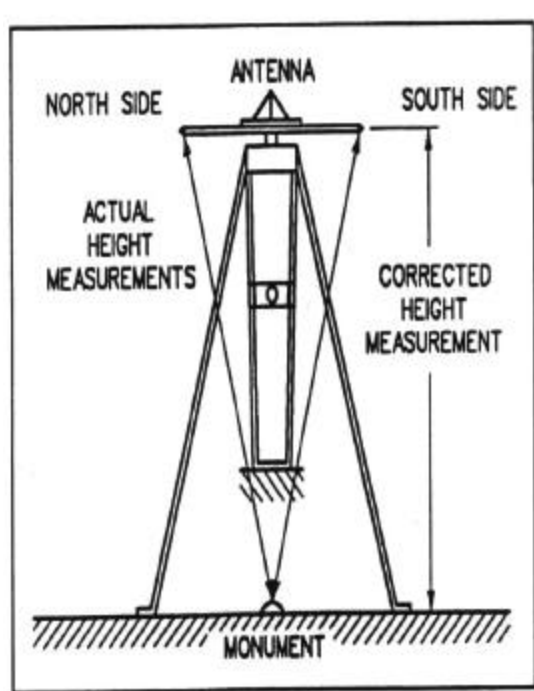

Figure F-7. Diagram of Antenna Setup

F-3. Post-Processing Observation Data

All recorded observation data were downloaded from the receivers to 5.25" floppy discs. The downloading procedures detailed in the manufacturer's operating manuals were strictly adhered to.

a. Once the observation data was downloaded, preprocessing of data was performed. Preprocessing of data included checking the station names, antenna heights, latitude and longitude of the points, elevation of the points, as well as applying any required corrections. In general, most GPS processing software requires the antenna slope height be corrected to vertical at some point in the survey, usually during the preprocessing phase (consult receiver/software manufacturer guidelines for specifics).

b. The data for the Ukiah project was post-processed using Trimble software TRIMVEC Version 88.028--GPS Relative Positioning Solution), but in general, all post-processing software produces similar results. The observation data was processed in accordance with manufacturer guidelines (see Chapter 10 for further discussion on GPS baseline post-processing).

(1) An examination of the results reveals the following, which are produced in one form or another in other manufacturer's solution file formats:

- a--Listing of the filename
- b--Types of solutions (single, double, or triple difference)
- c--Satellite availability during the survey for each station occupied
- d--Ephemeris file used for solution formulation
- e--Type of satellite selection (manual or automatic)
- f--Elevation mask
- g--Minimum number of satellites used
- h--Meteorological data (pressure, temperature, humidity)
- i--Session time (date, time)
- j--Data logging time (start, stop)
- k--Station information: Location (latitude, longitude); Receiver serial number used; Antenna serial number used; ID number; Antenna height
- l--RMS
- m--Solution files: dx, dy, dz between station; Slope distance between station; dlatitude, dlongitude between station; Distance between station; dheight
- n--Epoch intervals
- o--Number of epochs

(2) The triple difference, double difference float, and double difference fix Trimble solutions of the baseline reductions for baseline 2014--2002 were computed. The fixed solution is shown in Figures F-8a through F-8d--annotated with the above conventions (a through o) provided as an explanation. A summary of all solutions is shown in Figure F-8e. The baseline formulations are reproduced from the Trimble Navigation TRIMVEC solution file.

c. In general, all GPS manufacturer data reduction software programs produce a summary of results once data has been reduced and a baseline formulated.

d. Although the Trimble summary solution file does specify that the integers were found, the RMS is OK, and FIXED solution is recommended, an analysis of the output prior to this conclusion in accordance with Chapter 10 would have revealed the following:

(1) With a baseline distance of 7000 m for the formulated baseline (baseline 1402) and from Table 10-2 (Fixed Solution Acceptance Criteria), the RMS must be less than $(0.02+(0.004*d))$. Using the formula $(0.02+(0.004/d))$ from Table 10-2 with a distance (d) equal to 7 km, the equation is $(0.02 + (0.004*7))$ and the RMS is approximately equal to 0.048. Therefore, the RMS is acceptable.

(2) With a baseline distance of 7000 m for the formulated baseline (baseline 1402) and from Table 10-3, the variance ratio must be more than 1.5. The fixed solution factor from the summary solution file is 18.9. Therefore, the fixed solution quality factor is acceptable.

(3) From Table 10-3, with a baseline length of 7 km for baseline 1402 (between 0 - 20 km), an acceptable RMS (small), an acceptable variance ratio (large), and an integer solution, the fixed solution should be acceptable.

e. All other formulated baselines for this survey were found to be acceptable.

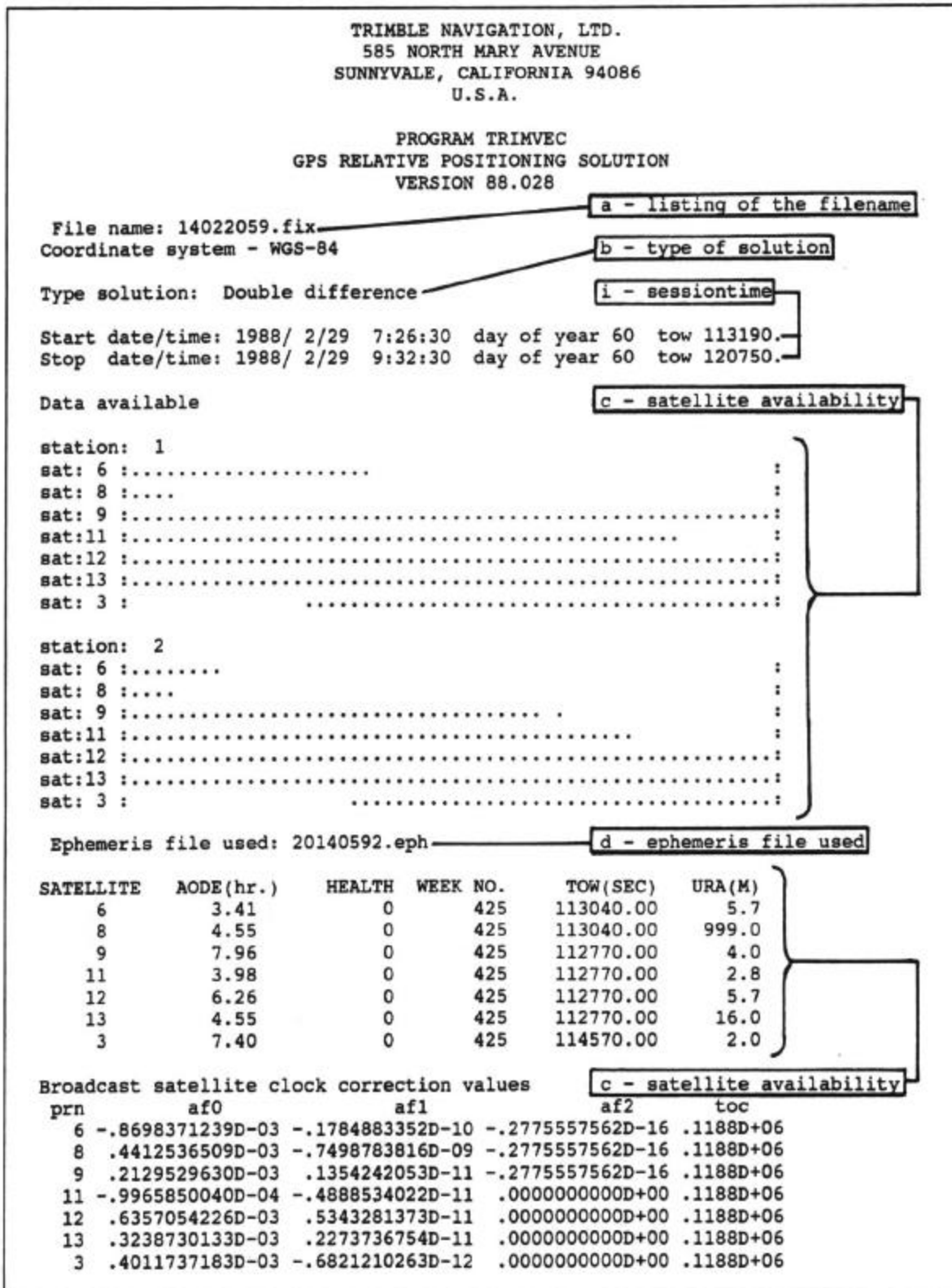

Figure F-8a. TRIMBLE Baseline Solution File (Ukiah Baseline 2014--2002)

```

Message file for station 1
.....
Station ID: 2014 Session #: 059-2 Feb. 29, 1988 07:24
Reference Position - HIGH ACCURACY:
Lat.= 39:07'57.401"N Long.=123:12'14.788"W Height=190.2 [meters]
Antenna height = 1.4387 [meters] (entered in the field of feet)
Receiver serial # = 4604
Antenna serial # = 110 (entered in the office)

Survey schedule mode = AUTOMATIC
Data-logging start time = 07:26
Data-logging stop time = 09:33

Ch0 Ch1 Ch2 Ch3 Ch4 Ch5 Ch6 Ch7 Ch8 Ch9
SVs 3 6 8 9 11 12 13 0 0 0
# meas 379 170 28 506 445 506 506 0 0 0
# cont 379 170 28 506 445 506 506 0 0 0

SV Selection mode = MANUAL SELECTION
Elevation mask = 20 [degrees] Minimum # of SVs = 4 selection

4 SV Position Best PDOP Position [ 3.1] Mean Position [497]
Latitude: 39:07'57.17388" N 39:07'57.14899" N
Longitude: 123:12'14.47260"W 123:12'14.64029" W
Height [m]: 169.0 170.3

3 SV Position Best PDOP Position [ 2.5] Mean Position [9]
Latitude: 39:07'57.62620" N 39:07'57.51783" N
Longitude: 123:12'14.95426" N 123:12'14.88427" N
.....
Origin of station 1 coordinates: Best C/A code tracking solution
STATION (mark) 1

input data file 1 : 20140592.dat
antenna height (m) 1.378

met values used: pressure(mb) 1010.0
temperature(deg C) 20.0
relative humidity(%) 50.0

x (m) -2713023.277 lat (dms) N 39 7 57.13720
y (m) -4145293.358 elon (dms) E 236 47 45.39187
z (m) 4003847.775 wlon (dms) W 123 12 14.60813
ht (m) 168.8847

Message file for station 2
.....
Station ID: 2002 Session #: 059-2 Feb 29, 1988 07:21
Reference Position - LOW ACCURACY:
Lat.= 39:12'30.000"N Long.=123:10'30.000"W Height=244.0 [meters]
Antenna height = 0.1201 [meters] (entered in the field in feet)
Receiver serial # = 4606
Antenna serial # = 108 (entered in the office)

Survey schedule mode = AUTOMATIC
Data-logging start time = 07:23
Data-logging stop time = 09:32

```

Figure F-8b. TRIMBLE Baseline Solution File (Ukiah Baseline 2014-2002)

```

      Ch0  Ch1  Ch2  Ch3  Ch4  Ch5  Ch6  Ch7  Ch8  Ch9
SVs      3    6    8    9   11   12   13    0    0    0
# meas   356  78   41  392  457  515  515    0    0    0
# cont   356  65   41  381  457  515  515    0    0    0

SV Selection mode = MANUAL SELECTION e - type of satellite selection
Elevation mask   = 20 [degrees] Minimum # of SVs = 4
f - elevation mask q - minimum # of satellite
4 SV Position    Best PDOP Position [ 3.5] Mean Position [358] used
Latitude:        39:11'36.62852" N          39:11'36.67782" N
Longitude:       123:11'00.34360" W         123:11'00.44659" W
Height [m]:      251.8                      247.9
                k - station information
3 SV Position    Best PDOP Position [ 2.5] Mean Position [157]
Latitude:        39:11'36.93995" N          39:11'36.76322" N
Longitude:       123:11'00.75300" W         123:11'00.69634" W
.....
STATION (mark) 2
input data file 1 : 20020592.dat k - station information
antenna height (m) .120
met values used:  pressure(mb)      1010.0
                  temperature(deg C) 20.0 h - meteorological data
                  relative humidity(%) 50.0
x (m) -2709224.271 lat (dms) N 39 11 36.66495
y (m) -4142739.345 elon (dms) E 236 48 59.56810
z (m)  4009144.592 wlon (dms) W 123 11 43.190
                  ht (m)      244.2339

slope distance (m) 7000.8355 sigma (m) .015
normal section azimuth (dms) 14 43 51.65
vertical angle (dms) 0 35 6.58

east(m) north(m) up(m) 1780.090 6770.367 71.498 m - solution file
Delta lat(dms) 0 3 39.52775
Delta lon(dms) 0 1 14.17622
Delta ht(m) 75.3491

Vector covariance matrix (m**2) :
                dx                dy
dx  .785657836034D-04
dy  .673839449077D-04 .723510872927D-03
dz  -.843065752912D-04 -.504546156900D-03 .464958813305D-03
correlations:
dx  dy  dz trop bias1 bias2 bias3 bias4 bias5 bias6
bias7
dx 1.000
dy .283 1.000
dz -.680 -.870 1.000
trop .000 .000 .000 1.000
bias1 .000 .000 .000 .000 1.000
bias2 .000 .000 .000 .000 .000 1.000
bias3 .000 .000 .000 .000 .000 .000 1.000
bias4 .000 .000 .000 .000 .000 .000 .000 1.000
bias5 .000 .000 .000 .000 .000 .000 .000 .000 1.000
bias6 .000 .000 .000 .000 .000 .000 .000 .000 .000 1.000
bias7 .000 .000 .000 .000 .000 .000 .000 .000 .000 .000
1.000

```

Figure F-8c. TRIMBLE Baseline Solution File (Ukiah Baseline 2014--2002)

	Solution	Sigma	Sensitivity to 10 meter error in station 1 coordinates		
dx (m)	3799.006	.009	9.999	.000	-.002
dy (m)	2554.013	.027	-.001	10.000	-.001
dz (m)	.000	.000	.000	.000	10.000
trop (%)	.000	.000	.000	.000	.000
bias 1 (cycle)	.000	.000	.000	.000	.000
bias 2 (cycle)	.000	.000	.000	.000	.000
bias 3 (cycle)	.000	.000	.000	.000	.000
bias 4 (cycle)	.000	.000	.000	.000	.000
bias 5 (cycle)	.000	.000	.000	.000	.000
bias 6 (cycle)	.000	.000	.000	.000	.000
bias 7 (cycle)	.000	.000	.000	.000	.000
Results of integer bias search:					
	.0549	1.06578		1.36295	
	0		1		0
	0		0		0
	0		0		0
	0		0		0
	0		0		0
	0		0		0
Ratio sum-of-squares(2) to sum-of-squares(1)			18.87		
Interval between epochs (sec)			120		
Epoch increment			4		
Number of measurements used in solution			161		
Number of measurements rejected			56		
RMS (cycles)			.020		
Elevation mask (deg)			15.0		
Edit multiplier			3.5		
Modified Hopfield troposphere model used					
Best tracking C/A code positions					
Station 1					
Pdop	3.1				
x (m)	-2713023.862	lat (dms)	N 39 7	57.13720	
y (m)	-4145294.253	elon (dms)	E 236 47	45.39187	
z (m)	4003848.645	wlon (dms)	W 123 12	14.60813	
		ht (m)		170.2629	
clock offset(s) .43266808D-03					
freq offset(s/s) -.11042348D-08					
Code calibration(m) Carrier calibration(m)					
1 - 2	.2520			.0012	
1 - 3	.0552			-.0006	
1 - 4	-.0249			-.0007	
1 - 5	.9292			-.0008	
1 - 6	-.2124			-.0010	
1 - 7	-.0181			.0005	
1 - 8	-.1875			-.0009	
1 - 9	-.1875			-.0012	
1 - 10	1.0630			-.0014	
Station 2					
Pdop	2.5				
x (m)	-2709227.033	lat (dms)	N 39 11	37.11338	
y (m)	-4142726.880	elon (dms)	E 236 48	59.18749	
z (m)	4009155.162	wlon (dms)	W 123 11	.81251	
		ht (m)		244.0000	
clock offset(s) .88584966D-03					
freq offset(s/s) .58827784D-09					
Code calibration(m) Carrier calibration(m)					
1 - 2	.2021			.0007	
1 - 3	-.3682			-.0011	
1 - 4	-.4199			-.0010	
1 - 5	-.5342			-.0013	
1 - 6	-.5234			-.0011	
1 - 7	-.2754			-.0002	
1 - 8	-.6040			-.0014	
1 - 9	-.8003			-.0020	
1 - 10	-.6953			-.0017	

Figure F-8d. TRIMBLE Baseline Solution File (Ukiah Baseline 2014--2002)

TRIMVEC GPS RELATIVE POSITIONING SOLUTION SUMMARY: VERSION 88.028

SOLUTION OUTPUT FILE: a:14022059.fix

STATION 1: Station ID: 2014 Session No.: 059-2 Feb 29,1988
07:24

Data-logging start time = 07:26 Data-logging stop time = 09:33

STATION 2: Station ID: 2002 Session #: 059-2 Feb 29,1988 07:21

Data-logging start time = 07:23 Data-logging stop time = 09:32

STATION COORDINATES:

Sta	Ant (m)	Latitude	Longitude	Hgt (m)
1	1.378	39:07'57.13720" N	123:12'14.60813" W	168.885
2 [TRP]	0.120	39:11'36.66538" N	123:11'00.43314" W	244.226
2 [FLT]	0.120	39:11'36.66472" N	123:11'00.43068" W	244.249
2 [FIX]	0.120	39:11'36.66495" N	123:11'00.43190" W	244.234

Origin of station 1 coordinates : Best C/A code tracking solution

SOLUTION SUMMARY:

Solution	dx (m)	dy (m)	dz (m)	dh (m)	RDOP
TRIPLE	3798.989	2554.042	5296.822	75.341	n/a
FLOAT	3799.022	2553.984	5296.821	75.365	n/a
FIXED	3799.006	2554.013	5296.817	75.349	n/a
FLT-FIX	0.016	-0.029	0.004	0.016	

Solution	Slope (m)	sig	Epochs/Rejected	Epoch int	Epoch inc
TRIPLE	7000.8406	[0.032]	168/ 1	150 (secs)	5 (epochs)
FLOAT	7000.8363	[0.036]	167/ 50	120 (secs)	4 (epochs)
FIXED	7000.8355	[0.015]	161/ 56	120 (secs)	4 (epochs)

Fixed solution quality factor: 18.9
Fixed solution rms: 0.020 (cycles)
Maximum float - fixed delta: 2.0 (cm)

Integers found, RMS is OK, FIXED solution recommended.

Figure F-8e. TRIMBLE Baseline Solution Summary File (Ukiah Baseline 2014--2002)

F-4. Loop Closure

An approximate loop closure was done by following the procedures detailed in Chapter 10.

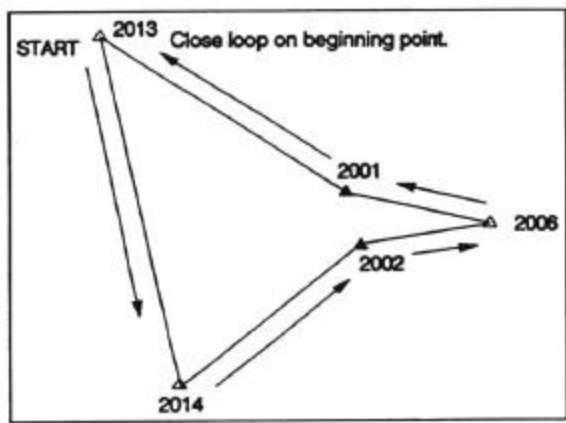

Figure F-9. Loop Closure (Ukiah)

The resulting calculations would proceed as shown in the following computation:

a. Follow Figure F-9, holding 2013 as the starting point.

b. Formulate a table similar to that shown in Chapter 10, where all values are taken from the GPS post-processed baseline formulations:

Baseline	Δx (m)	Δy (m)	Δz (m)	Distance(m)
13142059.FIX 2013 -> 2014	-3367.429	-7891.019	-10410.673	13490.362
14021059.FIX 2014 -> 2002	3799.005	2554.018	5296.798	7000.823
02053056.FIX 2002 -> 2006	953.294	-748.319	-16.709	1212.035
06013056.FIX 2006 -> 2001	-666.617	1441.548	908.280	1829.593
01132059.FIX 2001 -> 2013	-718.244	4683.775	4222.288	6317.297

c. Sum up the Δx , Δy , Δz , and distance components:

$$\begin{aligned} \Sigma \Delta x \text{ components} &= \Delta x(2013 \rightarrow 2014) + \Delta x(2014 \rightarrow 2002) + \Delta x(2002 \rightarrow 2006) + \Delta x(2006 \rightarrow 2001) \\ &\quad + \Delta x(2001 \rightarrow 2013) = -3367.429 + 3799.005 + 953.294 + (-666.617) + (-718.244) = \underline{0.009} \end{aligned}$$

$$\begin{aligned} \Sigma \Delta y \text{ components} &= \Delta y(2013 \rightarrow 2014) + \Delta y(2014 \rightarrow 2002) + \Delta y(2002 \rightarrow 2006) + \Delta y(2006 \rightarrow 2001) \\ &\quad + \Delta y(2001 \rightarrow 2013) = -7891.019 + 2554.018 + (-748.319) + 1441.548 + 4643.775 = \underline{0.003} \end{aligned}$$

$$\begin{aligned} \Sigma \Delta z \text{ components} &= \Delta z(2013 \rightarrow 2014) + \Delta z(2014 \rightarrow 2002) + \Delta z(2002 \rightarrow 2006) + \Delta z(2006 \rightarrow 2001) \\ &\quad + \Delta z(2001 \rightarrow 2013) = -10410.673 + 5296.798 + (-16.709) + 908.280 + 4222.288 = \underline{-0.016} \end{aligned}$$

$$\begin{aligned}\Sigma\text{Distances} &= (2013\text{-}\rightarrow\text{2014}) + (2014\text{-}\rightarrow\text{2002}) + (2002\text{-}2006) + (2006\text{-}\rightarrow\text{2001}) + (2001\text{-}\rightarrow\text{2013}) \\ &= 13490.362 + 7000.823 + 1212.035 + 1829.593 + 6317.297 = \underline{29850.110}\end{aligned}$$

d. From Equation (10-1):

$$m = \text{sqrt} [0.009^2 + 0.003^2 + (-0.016)^2] = 0.018601075 \text{ or } 0.0186$$

Therefore, misclosure is approximately 0.0186 in 29850.110 m, or 1 part in 1,600,000.

F-5. Final Adjustment

The program used for final adjustment of the Ukiah survey was the GEOLAB program (Version 1.82--1987). For an in depth technical discussion on GEOLAB, refer to the literature accompanying the GEOLAB software package. The following discussion on the GEOLAB adjustment of the Ukiah survey highlights some of the criteria used in the adjustment of a horizontal survey.

a. The input data file for a GEOLAB adjustment is called an "IOB" file. An IOB file can be created using a text editor program or with a GEOLAB option called "GPS Environment." An IOB file is specific to the GEOLAB adjustment software and may or may not be required by other least-square adjustment software (refer to Chapter 11 or the owner's manual). The GEOLAB Environment option takes GPS baseline solution files developed by most GPS manufacturers and automatically sets up an IOB file for adjustment.

b. The IOB input file generally consists of the following information:

- (1) Top Line. Title Record - usually a project name and an adjustment number.
- (2) Second Line. Options Record - this record specifies which GEOLAB options are to be activated for processing.
- (3) Third Line. Ellipsoid Specification Record - Prints ellipsoid parameters chosen in the Options Record or as chosen by the user.
- (4) Station Information Section. All stations must have their coordinates defined here. The coordinates must be given as ellipsoidal latitude, longitude, and orthometric height, or as Cartesian coordinates. In this section, stations are either held fixed or are to be adjusted. If stations are not held fixed, estimated coordinates are input.
- (5) Auxiliary Parameter Definition Record. The auxiliary parameter group definition record is optional, but can be used if GEOLAB is to solve for various scale, orientation, translation, or constant parameters. In the sample GEOLAB input, enough vertical and horizontal control is held fixed to solve for SCALE and ROTATION. Rotation is about the Cartesian X-axis, Y-axis, and Z-axis.
- (6) Observation Records Section. In the example GEOLAB input file, only GPS observations are entered. Each baseline is entered separately with the station name and Cartesian coordinate differences between the stations, which is the computed baseline. These can also be entered as $\Delta x=0$, $\Delta y=0$, $\Delta z=0$, for station 1 and the 3 D baseline for station 2. For example, baseline 1 would be entered as:

STATION	Δx	Δy	Δz
92 2001	0.000	0.000	0.000
92 2006	-666.617	1441.548	908.280

The correlation matrix elements from the baseline solution are also entered and the last line of the observation record is the standard deviation for Δx , Δy , and Δz .

- c. Figure F-10 depicts GEOLAB input with annotations using the above convention.
- d. Once an IOB file containing parameters necessary to perform an adjustment has been completed, the adjustment can begin. The first step is to select the baselines needed for the adjustment. The baselines chosen must have been processed adequately, as detailed in Chapter 10, or as recommended by the GPS manufacturer.
- e. The example IOB file shown in Figure F-10 was adjusted as shown in Figure F-11.
- f. For the first adjustment (Figure F-11), one point was held fixed in 3D, producing a free adjustment). A free adjustment checks the internal consistency of a GPS survey--refer to Chapter 11 for further details.
- g. A second adjustment (not shown) can be done to check the existing network if these control points are directly tied together with GPS baselines. To do this with GEOLAB, the user must set up an IOB file with only the fixed control and the respective baselines connecting them. Hold fixed all control except one point, then perform the adjustment. Next, fix that control point and free one of the others, and keep repeating this procedure until all control points have been allowed to be checked against it's true position. If the position of one control point is "bad", that point can generally be omitted from the subsequent constrained adjustment or allowed to adjust with the other points.
- h. A final constrained adjustment (Figure F-12) should hold fixed all good horizontal and vertical control. Adjust and check the output as detailed in Chapter 11.

F-6. Check of the Final Adjustment

After each adjustment was run, the 2-D and 1-D station (absolute) error ellipse for each adjusted point was reviewed (for further discussion on error ellipses and adjustments, refer to Chapter 11). These are listed as major semi-axis, minor semi-axis, major azimuth, and vertical. The sizes of the error ellipses listed in this portion of the GEOLAB adjustment are an indication of the internal consistency of the GPS survey. The smaller the size of the ellipse, the better the survey. The size of the ellipse will also generally become larger as the project size increases. In the constrained adjustment shown, the major semi-axis and minor semi-axis are of the mm level (0.0066 and 0.0048 mm for 2001 and 0.0062 and 0.0044 mm, respectively) - which is acceptable.

a. The 2-D and 1-D relative error ellipses and line accuracies (i.e. precision) between survey points were checked. These are listed as major semi-axis, minor semi-axis, major azimuth, vertical, spatial distance, and precision (as shown on labeled page 16 of the free adjustment and page 17 of the constrained adjustment). When checking these values, one should remember they are relative values. The relativity of points used in the adjustment can sometimes produce deceptive values, higher major semi-axis and minor semi-axis values: this may occur between points that are close together, but have not been tied together by a baseline. Because of the possibility of the production of deceptive results, the user must take special care when reviewing these values. In the constrained adjustment shown, the major semi-axis and minor semi-

axis are of the mm level (0.0045 and 0.0036 for the baseline 2001->2002). The project precision in parts per million (ppm) is also listed in this portion of the adjustment and should be checked.

b. The histograms in the GEOLAB adjustments were reviewed. The histogram is a visual representation of the standardized (normalized) residuals. The histogram shows whether the residuals are symmetrical about the mean residual, the total spread of values of the residuals, the frequencies of the different values, and how peaked or how flat the distribution of the residuals may be. A generally good looking histogram has data that, when graphed, is in the shape of a bell curve.

c. The free adjustment line accuracy precessions shown on Figure F-11 are the primary criteria used to evaluate the survey adequacy. The worst precision (4.182 ppm between 2001 and 2013) equates to 1:239,000. This far exceeds the required project accuracy (1:10,000). The relative line accuracy between 2001 and 2002 on the constrained adjustment was 3.846 ppm, or 1:260,000. This indicates excellent connections with existing control.

d. The variance factor shown on each adjustment is within acceptable limits (0.5 to 1.5). As such, it could be used to determine outlier limits for rejection of data, as explained in Chapter 11.

e. The residual corrections to each baseline component are shown on each adjustment. Special review is made of the Standardized Residuals, which one will find is approximately comparable to Normalized Residuals in GEOLAB software. None of the residuals were flagged (based on Tau Max testing) for exceeding tolerance.

f. The 3-D positional and relative confidence regions (ellipsoid) and 3-D line accuracy precessions are shown at the end of each adjustment. These statistics are not applicable for most USACE work.

g. Of all the output statistics, only the residuals, standardized residuals, relative 2-D/1-D line precessions, and variance factor have useful application for USACE work. The histograms, Chi-square tests, 3-D ellipsoid, etc. are useful only if one understands their derivation and application.

h. The results of the free and constrained adjustments in this example were not significantly different. This is usually not the case--typically, station/line accuracies degrade on the constrained adjustment.

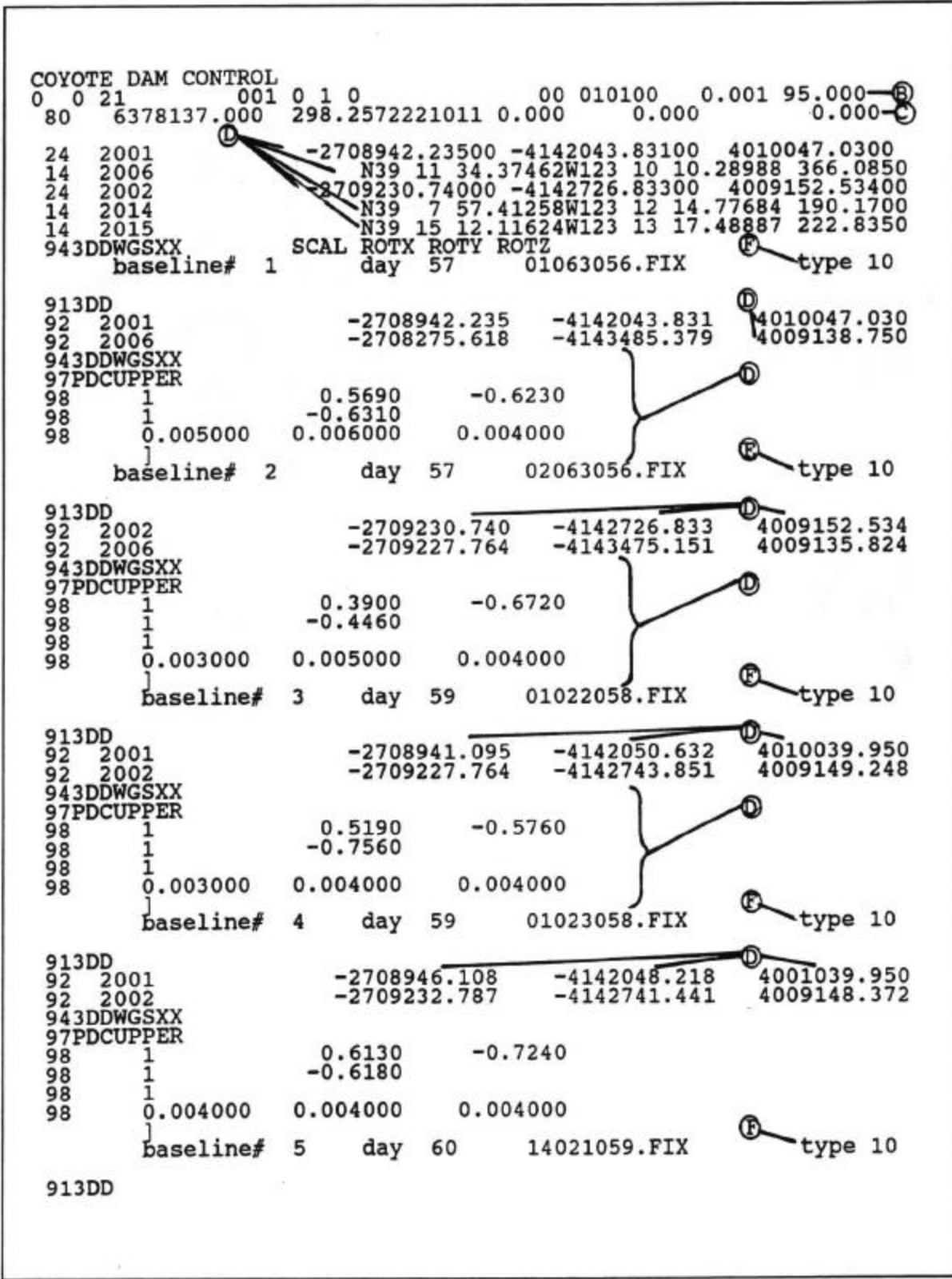

Figure F-10a. GEOLAB Input (Ukiah)

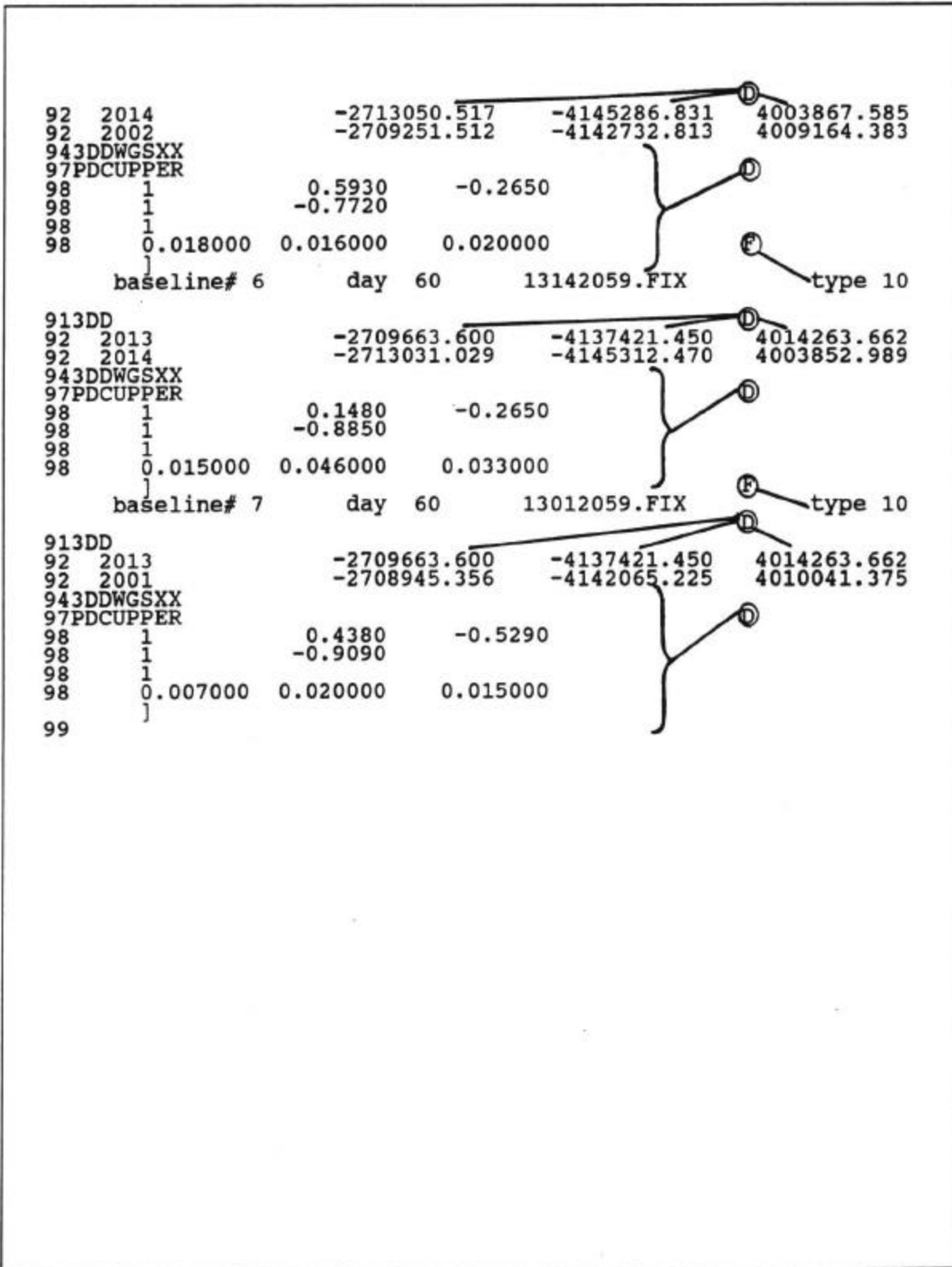

Figure F-10b. GEOLAB Input (Ukiah)

U.S. ARMY ENGINEER TOPOGRAPHIC LABORATORIES			
COYOTE DAM FREE ADJUSTMENT MAD-83			
A= 6378137.000 B= 6356752.314		X0= 0.000 Y0= 0.000 Z0= 0.000	
PREPARE: ASCII input file: <coyote_2.iob>.			
PREPARE successfully completed.			
GeoLab - V1.82S, (C) 1985/86/87 BitWise Ideas Inc. [103207696]		Page 0	
GETUP:			
PARAMETERS		OBSERVATIONS	
Description	Number	Description	Number
All Stations	5	Directions	0
Fixed Stations	1	Distances	0
Free 3-D Stations	4	Azimuths	0
Free 2-D Stations	0	Vertical Angles	0
Free 1-D Stations	0	Zenithal Angles	0
Coord. Parameters	12	Angles	0
Astro. Latitudes	0	Heights	0
Astro. Longitudes	0	Height Differences	0
Geoid Records	0	Auxiliary Params.	0
All Aux. Pars.	0	2-D Coords.	0
Direction Pars.	0	2-D Coord. Diffs.	0
Scale Parameters	0	3-D Coords.	0
Constant Pars.	0	3-D Coord. Diffs.	21
Rotation Pars.	0		
Translation Pars.	0		
Total Parameters	12	Total Observations	21
Degrees of Freedom = 9			
GeoLab - V1.82S, (C) 1985/86/87 BitWise Ideas Inc. [103207696]		Page 1	
SUMMARY OF SELECTED OPTIONS			
OPTION	SELECTION		
Computation Mode	Adjustment		
Linear Unit	Metre		
Maximum Iterations	2		
Confidence Regions Selected	All		
Confidence Region Dimensions	1-D, 2-D, and 3-D		
Print Input Station Data	On		
Variance Factor Knowledge	Known		
Confidence Level for Statistics	95.000		
Dual-Height Mode	Off		
Print Solution Vector	On All Iterations		
Printed Ellipsoidal Coordinates	5 Decimal Places		
Print Adjusted X, Y, Z	On		
Print Histograms	On		
Print Misclosures	On All Iterations		
Print Residuals	All		
Variance Factor Usage	Scale Confidence Regions		
Residual Rejection Criterion	Tau Max		
Angular Misclosure Limit Factor	10		
Linear Misclosure Limit Factor	10		
Convergence Criterion	0.001000		
GeoLab - V1.82S, (C) 1985/86/87 BitWise Ideas Inc. [103207696]		Page 2	

Figure F-11a. GEOLAB Adjustment Output (Free)

U.S. ARMY ENGINEER TOPOGRAPHIC LABORATORIES						
COYOTE DAM FREE ADJUSTMENT						
A=	6378137.000	B=	6356752.314	X0=	0.000	Y0= 0.000 Z0= 0.000
CODE IDENT.	DESCRIPTOR	INITIAL VALUES				
14 2006	ELLIPSOIDAL :	39 11 34.37462	-123 10 10.28988	336.0850		
	ASTRONOMIC :	39 11 34.37462	-123 10 10.28988	336.0850		
	GEOIDAL :	0 0 0.00000	0 0 0.00000	0.0000		
	CARTESIAN :	-2708280.4788	-4143494.7721	4009147.8933		
24 2001	ELLIPSOIDAL :	39 12 14.43422	-123 11 6.45941	243.8658		
	ASTRONOMIC :	39 12 14.43422	-123 11 6.45941	243.8658		
	GEOIDAL :	0 0 0.00000	0 0 0.00000	0.0000		
	CARTESIAN :	-2708942.2350	-4142043.8310	4010047.0300		
24 2002	ELLIPSOIDAL :	39 11 37.00656	-123 11 0.94286	243.8815		
	ASTRONOMIC :	39 11 37.00656	-123 11 0.94286	243.8815		
	GEOIDAL :	0 0 0.00000	0 0 0.00000	0.0000		
	CARTESIAN :	-2709230.7400	-4142726.8330	4009152.5340		
24 2014	ELLIPSOIDAL :	39 7 57.44196	-123 12 15.70589	188.7219		
	ASTRONOMIC :	39 7 57.44196	-123 12 15.70589	188.7219		
	GEOIDAL :	0 0 0.00000	0 0 0.00000	0.0000		
	CARTESIAN :	-2713050.5170	-4145286.8310	4003867.5850		
24 2013	ELLIPSOIDAL :	39 15 11.55819	-123 13 17.15396	220.5009		
	ASTRONOMIC :	39 15 11.55819	-123 13 17.15396	220.5009		
	GEOIDAL :	0 0 0.00000	0 0 0.00000	0.0000		
	CARTESIAN :	-2709663.6000	-4137421.4500	4014263.6620		
GETUP successfully completed.						
GeoLab - V1.82s, (C) 1985/86/87 BitWise Ideas Inc. [103207696]						Page 3
FORMEQ: NOTE 6: Reordering was done.						
AT	TO	OBS TYPE	OBSERVATION	APPROX. SIG.	MISCLOSURE	
2001	2006	3-D X-Coord Diff	666.6170	0.0037	-4.8608	
2001	2006	3-D Y-Coord Diff	-1441.5480	0.0045	-9.3931	
2001	2006	3-D Z-Coord Diff	-908.2800	0.0028	9.1433	
2002	2006	3-D X-Coord Diff	953.2950	0.0022	-3.0338	
2002	2006	3-D Y-Coord Diff	-748.3180	0.0044	-19.6211	
2002	2006	3-D Z-Coord Diff	-16.7100	0.0029	12.0693	
2001	2002	3-D X-Coord Diff	-286.6690	0.0024	-1.8360	
2001	2002	3-D Y-Coord Diff	-693.2190	0.0026	10.2170	
2001	2002	3-D Z-Coord Diff	-891.5890	0.0025	-2.9070	
2001	2002	3-D X-Coord Diff	-286.6790	0.0026	-1.8260	
2001	2002	3-D Y-Coord Diff	-693.2230	0.0030	10.2210	
2001	2002	3-D Z-Coord Diff	-891.5780	0.0026	-2.9180	
2014	2002	3-D X-Coord Diff	3799.0050	0.0129	20.7720	
2014	2002	3-D Y-Coord Diff	2554.0180	0.0101	5.9800	
2014	2002	3-D Z-Coord Diff	5296.7980	0.0113	-11.8490	
2013	2014	3-D X-Coord Diff	-3367.4290	0.0142	-19.4880	
2013	2014	3-D Y-Coord Diff	-7891.0200	0.0210	25.6390	
2013	2014	3-D Z-Coord Diff	-10410.6730	0.0147	14.5960	
2013	2001	3-D X-Coord Diff	718.2440	0.0059	3.1210	
2013	2001	3-D Y-Coord Diff	-4643.7750	0.0083	21.3940	
2013	2001	3-D Z-Coord Diff	-4222.2870	0.0059	5.6550	
FORMEQ successfully completed.						
GeoLab - V1.82s, (C) 1985/86/87 BitWise Ideas Inc. [103207696]						Page 4

Figure F-11b. GEOLAB Adjustment Output (Free)

```

-----
                        U.S. ARMY ENGINEER TOPOGRAPHIC LABORATORIES
                        COYOTE DAM      FREE ADJUSTMENT
A= 6378137.000 B= 6356752.314 X0=      0.000 Y0=      0.000 Z0=      0.000
-----
SOLVE:      Solution (Iteration Count = 1):
CODE IDENT. TYPE          INITIAL          DX          UPDATED
-----
24 2001     LATITUDE    39 12 14.43422      0.01413      39 12 14.44836
24 2001     LONGITUDE  -123 11 6.45941      0.04476     -123 11 6.41465
24 2001     HEIGHT          243.86577      13.93969      257.80546

24 2002     LATITUDE    39 11 37.00656     -0.06729      39 11 36.93927
24 2002     LONGITUDE  -123 11 0.94286      0.34171     -123 11 0.60115
24 2002     HEIGHT          243.88154      21.63376      265.51530

24 2014     LATITUDE    39  7 57.44196     -0.02938      39  7 57.41258
24 2014     LONGITUDE  -123 12 15.70589      0.92905     -123 12 14.77684
24 2014     HEIGHT          188.72193      1.44519      190.16712

24 2013     LATITUDE    39 15 11.55819      0.55805      39 15 12.11624
24 2013     LONGITUDE  -123 13 17.15396     -0.33491     -123 13 17.48887
24 2013     HEIGHT          220.50094      2.33476      222.83570
SOLVE successfully completed.
-----
GeoLab - V1.82S, (C) 1985/86/87 BitWise Ideas Inc. [103207696]      Page      5
-----
FORMEQ:      FORMEQ successfully completed.
-----
GeoLab - V1.82S, (C) 1985/86/87 BitWise Ideas Inc. [103207696]      Page      6
-----
SOLVE:      Adjusted Values (Iteration Count = 2):
CODE IDENT. TYPE          INITIAL          DX          ADJUSTED
-----
14 2006     LATITUDE    39 11 34.37462          FIXED
14 2006     LONGITUDE  -123 10 10.28988          FIXED
14 2006     HEIGHT          336.08500          FIXED

24 2001     LATITUDE    39 12 14.44836     -0.00000      39 12 14.44836
24 2001     LONGITUDE  -123 11 6.41465     -0.00000     -123 11 6.41465
24 2001     HEIGHT          257.80546     -0.00000      257.80546

24 2002     LATITUDE    39 11 36.93927      0.00000      39 11 36.93927
24 2002     LONGITUDE  -123 11 0.60115     -0.00000     -123 11 0.60115
24 2002     HEIGHT          265.51530      0.00001      265.51530

24 2014     LATITUDE    39  7 57.41258     -0.00000      39  7 57.41258
24 2014     LONGITUDE  -123 12 14.77684     -0.00000     -123 12 14.77684
24 2014     HEIGHT          190.16712      0.00004      190.16716

24 2013     LATITUDE    39 15 12.11624     -0.00000      39 15 12.11624
24 2013     LONGITUDE  -123 13 17.48887     -0.00000     -123 13 17.48887
24 2013     HEIGHT          222.83570      0.00003      222.83573
-----
GeoLab - V1.82S, (C) 1985/86/87 BitWise Ideas Inc. [103207696]      Page      7
-----
                        Adjusted Cartesian Coordinates:
CODE IDENT. X-COORDINATE      Y-COORDINATE      Z-COORDINATE
-----
24 2001     -2708947.0978     -4142053.2284     4010056.1788
24 2002     -2709233.7714     -4142746.4510     4009164.5970
24 2014     -2713032.7730     -4145300.4675     4003867.7943
24 2013     -2709665.3421     -4137409.4529     4014278.4662
SOLVE successfully completed.
-----
GeoLab - V1.82S, (C) 1985/86/87 BitWise Ideas Inc. [103207696]      Page      8

```

Figure F-11c. GEOLAB Adjustment Output (Free)

```

-----
                U.S. ARMY ENGINEER TOPOGRAPHIC LABORATORIES
                COYOTE DAM      FREE ADJUSTMENT
A= 6378137.000 B= 6356752.314 X0= 0.000 Y0= 0.000 Z0= 0.000
-----
INVERT:      INVERT successfully completed.
-----
GeoLab - V1.82s, (C) 1985/86/87 BitWise Ideas Inc. [103207696]      Page 9
-----
RESID:
STATION  3-D COORD DIFFS      STD.DEV.  RESIDUAL  STD.DEV.  STAN.RES.
-----
2001      -2708942.2350
           -4142043.8310
           4010047.0300
2006      -2708275.6180      0.0050      0.0020      0.0040      0.4913
           -4143485.3790      0.0060      0.0043      0.0044      0.9722
           4009138.7500      0.0040      -0.0055      0.0026      -2.1131
=====
                        End of Observation Set =====
2002      -2709230.7400
           -4142726.8330
           4009152.5340
2006      -2708277.4450      0.0030      -0.0024      0.0015      -1.5684
           -4143475.1510      0.0050      -0.0031      0.0031      -1.0050
           4009135.8240      0.0040      0.0063      0.0026      2.4021
=====
                        End of Observation Set =====
2001      -2708941.0950
           -4142050.6320
           4010040.8370
2002      -2709227.7640      0.0030      -0.0046      0.0020      -2.2695
           -4142743.8510      0.0040      -0.0036      0.0031      -1.1723
           4009149.2480      0.0040      0.0072      0.0032      2.2790
=====
                        End of Observation Set =====
2001      -2708946.1080
           -4142048.2180
           4010039.9500
2002      -2709232.7870      0.0040      0.0054      0.0033      1.6114
           -4142741.4410      0.0040      0.0004      0.0031      0.1290
           4009148.3720      0.0040      -0.0038      0.0032      -1.1996
=====
                        End of Observation Set =====
2014      -2713050.5170
           -4145286.8310
           4003867.5850
2002      -2709251.5120      0.0180      -0.0034      0.0132      -0.2586
           -4142732.8130      0.0160      -0.0015      0.0077      -0.1983
           4009164.3830      0.0200      0.0047      0.0129      0.3661
=====
                        End of Observation Set =====
2013      -2709663.6000
           -4137421.4500
           4014263.6620
2014      -2713031.0290      0.0150      -0.0019      0.0092      -0.2019
           -4145312.4700      0.0460      0.0054      0.0407      0.1332
           4003852.9890      0.0330      0.0011      0.0275      0.0389
-----
GeoLab - V1.82s, (C) 1985/86/87 BitWise Ideas Inc. [103207696]      Page 10
-----
RESID:
STATION  3-D COORD DIFFS      STD.DEV.  RESIDUAL  STD.DEV.  STAN.RES.
-----
=====
                        End of Observation Set =====
2013      -2709663.6000
           -4137421.4500
           4014263.6620
2001      -2708945.3560      0.0070      0.0003      0.0021      0.1596
           -4142065.2250      0.0200      -0.0005      0.0076      -0.0670
           4010041.3750      0.0150      -0.0004      0.0055      -0.0743
=====
                        End of Observation Set =====
-----
GeoLab - V1.82s, (C) 1985/86/87 BitWise Ideas Inc. [103207696]      Page 11

```

Figure F-11d. GEOLAB Adjustment Output (Free)

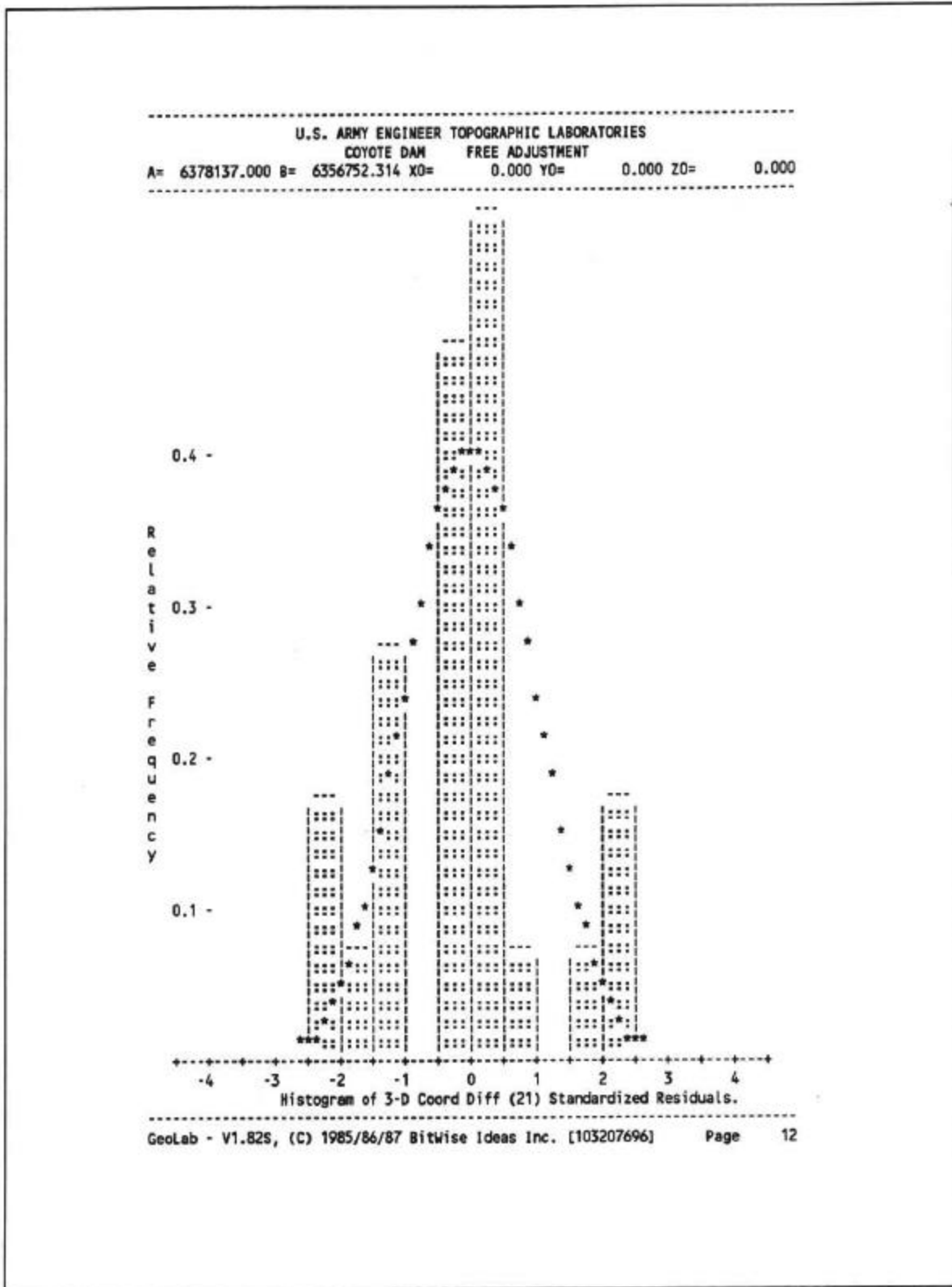

Figure F-11e. GEOLAB Adjustment Output (Free)

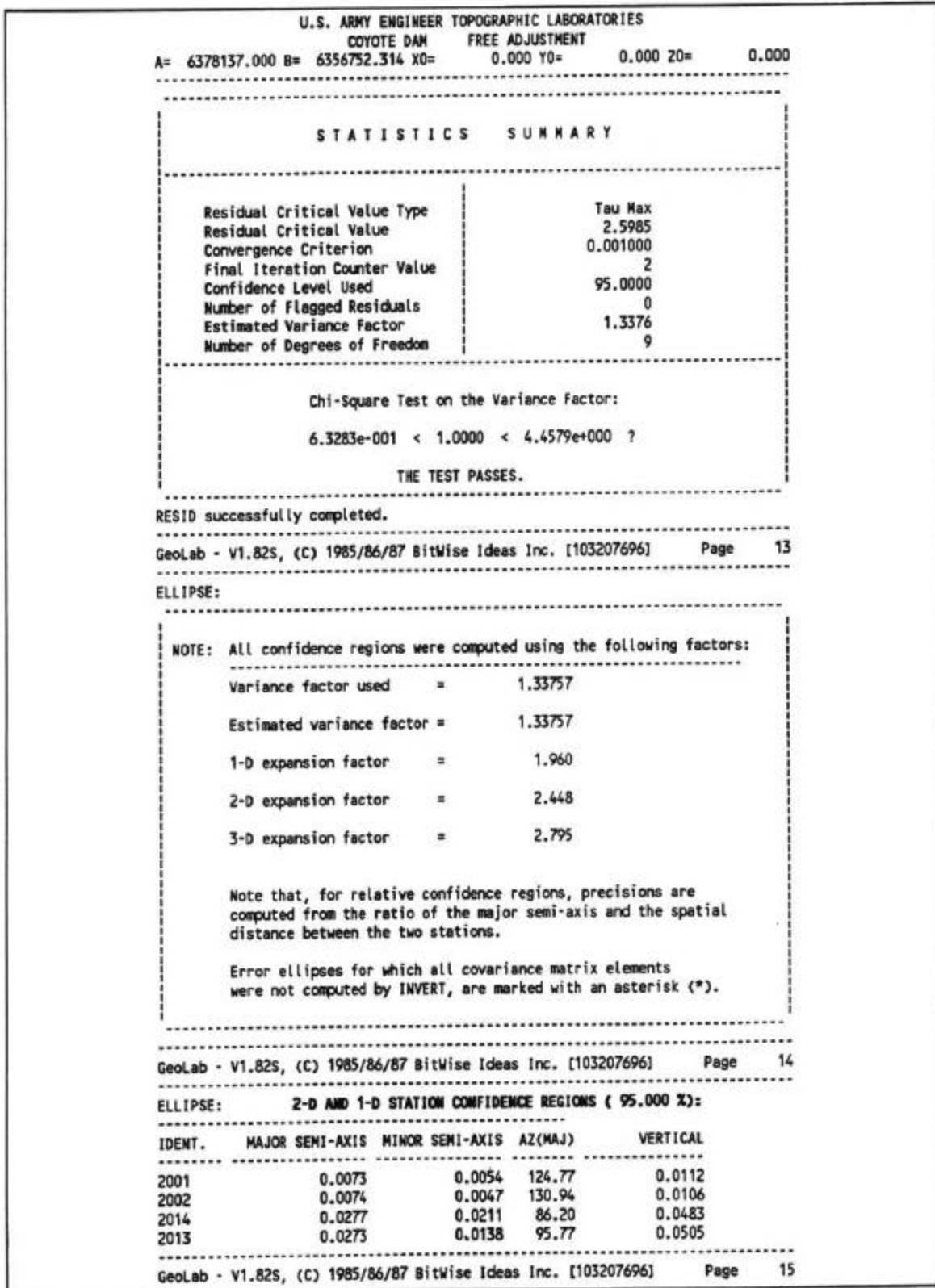

Figure F-11f. GEOLAB Adjustment Output (Free)

 U.S. ARMY ENGINEER TOPOGRAPHIC LABORATORIES
 COYOTE DAM FREE ADJUSTMENT
 A= 6378137.000 B= 6356752.314 X0= 0.000 Y0= 0.000 Z0= 0.000

ELLIPSE: 2-D AND 1-D RELATIVE STATION CONFIDENCE REGIONS (95.000 %):

FROM	TO	MAJ.SEMI	MIN.SEMI	AZ(MAJ)	VERTICAL	SPATIAL DIST.	PRECISION
2001	2002	0.0045	0.0038	105.27	0.0082	1165.1856	3.881 PPM
2001	2014	0.0272	0.0204	84.07	0.0475	8095.2706	3.363 PPM
2001	2013	0.0264	0.0125	94.67	0.0494	6317.2966	4.182 PPM
2002	2014	0.0271	0.0203	83.67	0.0473	7000.8237	3.871 PPM
2002	2013	0.0267	0.0130	94.73	0.0499	7404.1516	3.612 PPM
2014	2013	0.0359	0.0216	91.44	0.0607	13490.3592	2.665 PPM

 Geolab - V1.82S, (C) 1985/86/87 BitWise Ideas Inc. [103207696] Page 16

ELLIPSE: 3-D STATION CONFIDENCE REGIONS (95.000 %):

IDENT.	MAJOR SEMI-AXIS	MEDIUM SEMI-AXIS	MINOR SEMI-AXIS
2001	0.0161	0.0082	0.0059
	A=180.0 V= 80.4	A=298.9 V= 4.7	A= 29.6 V= 8.3
2002	0.0152	0.0082	0.0054
	A=161.8 V= 79.9	A=307.9 V= 8.4	A= 38.7 V= 5.6
2014	0.0690	0.0316	0.0237
	A=345.0 V= 86.1	A= 85.7 V= 0.7	A=175.8 V= 3.8
2013	0.0754	0.0219	0.0157
	A= 94.5 V= 72.1	A=279.0 V= 17.9	A=188.6 V= 1.3

 Geolab - V1.82S, (C) 1985/86/87 BitWise Ideas Inc. [103207696] Page 17

ELLIPSE: 3-D RELATIVE STATION CONFIDENCE REGIONS (95.000 %):

FROM	TO	MAJOR-SEMI	MED.-SEMI	MINOR-SEMI	SPATIAL DIST.	PRECISION
2001	2002	0.0117	0.0051	0.0044	1165.1856	10.011 PPM
		A= 0 V=90 A= 90 V= 0 A= 0 V= 0				
2001	2014	0.0679	0.0311	0.0228	8095.2706	8.392 PPM
		A=347 V=86 A= 84 V= 1 A=174 V= 4				
2001	2013	0.0739	0.0201	0.0142	6317.2966	11.704 PPM
		A= 93 V=72 A=279 V=18 A=188 V= 2				
2002	2014	0.0677	0.0309	0.0226	7000.8237	9.666 PPM
		A=342 V=85 A= 83 V= 1 A=173 V= 4				
2002	2013	0.0745	0.0210	0.0148	7404.1516	10.064 PPM
		A= 93 V=72 A=278 V=18 A=188 V= 1				
2014	2013	0.0887	0.0363	0.0245	13490.3592	6.577 PPM
		A= 85 V=76 A=275 V=14 A=185 V= 2				

ELLIPSE successfully completed.

 Geolab - V1.82S, (C) 1985/86/87 BitWise Ideas Inc. [103207696] Page 18

Figure F-11g. GEOLAB Adjustment Output (Free)

U.S. ARMY ENGINEER TOPOGRAPHIC LABORATORIES			
COYOTE DAM CONSTRAINED ADJUSTMENT NAD-83			
A= 6378137.000 B= 6356752.314 X0= 0.000 Y0= 0.000 Z0= 0.000			
PREPARE: ASCII input file: <coyote_1.iob>.			
PREPARE successfully completed.			
Geolab - V1.82S, (C) 1985/86/87 BitWise Ideas Inc. [103207696]			Page 0
GETUP:			
PARAMETERS		OBSERVATIONS	
Description	Number	Description	Number
All Stations	5	Directions	0
Fixed Stations	3	Distances	0
Free 3-D Stations	2	Azimuths	0
Free 2-D Stations	0	Vertical Angles	0
Free 1-D Stations	0	Zenithal Angles	0
Coord. Parameters	6	Angles	0
Astro. Latitudes	0	Heights	0
Astro. Longitudes	0	Height Differences	0
Geoid Records	0	Auxiliary Params.	0
All Aux. Pars.	4	2-D Coords.	0
Direction Pars.	0	2-D Coord. Diffs.	0
Scale Parameters	1	3-D Coords.	0
Constant Pars.	0	3-D Coord. Diffs.	21
Rotation Pars.	3		
Translation Pars.	0		
-----		-----	
Total Parameters	10	Total Observations	21
Degrees of Freedom = 11			
Geolab - V1.82S, (C) 1985/86/87 BitWise Ideas Inc. [103207696]			Page 1
GETUP: SUMMARY OF SELECTED OPTIONS			
OPTION	SELECTION		
Computation Mode	Adjustment		
Linear Unit	Metre		
Maximum Iterations	2		
Confidence Regions Selected	All		
Confidence Region Dimensions	1-D, 2-D, and 3-D		
Print Input Station Data	On		
Variance Factor Knowledge	Known		
Confidence Level for Statistics	95.000		
Dual-Weight Mode	Off		
Print Solution Vector	On All Iterations		
Printed Ellipsoidal Coordinates	5 Decimal Places		
Print Adjusted X, Y, Z	On		
Print Histograms	On		
Print Misclosures	On All Iterations		
Print Residuals	All		
Variance Factor Usage	Scale Confidence Regions		
Residual Rejection Criterion	Tau Max		
Angular Misclosure Limit Factor	10		
Linear Misclosure Limit Factor	10		
Convergence Criterion	0.001000		
Geolab - V1.82S, (C) 1985/86/87 BitWise Ideas Inc. [103207696]			Page 2

Figure F-12a. GEOLAB Adjustment Output (Constrained)

```

-----
                U.S. ARMY ENGINEER TOPOGRAPHIC LABORATORIES
                COYOTE DAM ADJUSTMENT NAD-83
A= 6378137.000 B= 6356752.314 X0= 0.000 Y0= 0.000 Z0= 0.000
-----
CODE IDENT.  DESCRIPTOR  INITIAL VALUES
-----
14 2006
    ELLIPSOIDAL : 39 11 34.37462 -123 10 10.28988 336.0850
    ASTRONOMIC  : 39 11 34.37462 -123 10 10.28988 336.0850
    GEODIAL     : 0 0 0.00000 0 0 0.00000 0.0000
    CARTESIAN   : -2708280.4788 -4143494.7721 4009147.8933

14 2013
    ELLIPSOIDAL : 39 15 12.11624 -123 13 17.48887 222.8350
    ASTRONOMIC  : 39 15 12.11624 -123 13 17.48887 222.8350
    GEODIAL     : 0 0 0.00000 0 0 0.00000 0.0000
    CARTESIAN   : -2709665.3418 -4137409.4525 4014278.4657

14 2014
    ELLIPSOIDAL : 39 7 57.41258 -123 12 14.77684 190.1700
    ASTRONOMIC  : 39 7 57.41258 -123 12 14.77684 190.1700
    GEODIAL     : 0 0 0.00000 0 0 0.00000 0.0000
    CARTESIAN   : -2713032.7742 -4145300.4693 4003867.7960

24 2001
    ELLIPSOIDAL : 39 12 14.43422 -123 11 6.45941 243.8658
    ASTRONOMIC  : 39 12 14.43422 -123 11 6.45941 243.8658
    GEODIAL     : 0 0 0.00000 0 0 0.00000 0.0000
    CARTESIAN   : -2708942.2350 -4142043.8310 4010047.0300

24 2002
    ELLIPSOIDAL : 39 11 37.00656 -123 11 0.94286 243.8815
    ASTRONOMIC  : 39 11 37.00656 -123 11 0.94286 243.8815
    GEODIAL     : 0 0 0.00000 0 0 0.00000 0.0000
    CARTESIAN   : -2709230.7400 -4142726.8330 4009152.5340

94 WGSXX
    300 SCAL : 0.00000
    300 ROTX : 0.00000
    300 ROTY : 0.00000
    300 ROTZ : 0.00000
GETUP successfully completed.
-----
GeoLab - V1.82S, (C) 1985/86/87 BitWise Ideas Inc. [103207696] Page 3
FORMEQ: NOTE 6: Reordering was done.
AT TO OBS TYPE OBSERVATION APPROX.SIG. MISCLOSURE
-----
2001 2006 3-D X-Coord Diff 666.6170 0.0037 -4.8608
2001 2006 3-D Y-Coord Diff -1441.5480 0.0045 -9.3931
2001 2006 3-D Z-Coord Diff -908.2800 0.0028 9.1433
2002 2006 3-D X-Coord Diff 953.2950 0.0022 -3.0338
2002 2006 3-D Y-Coord Diff -748.3180 0.0044 -19.6211
2002 2006 3-D Z-Coord Diff -16.7100 0.0029 12.0693
2001 2002 3-D X-Coord Diff -286.6690 0.0024 -1.8360
2001 2002 3-D Y-Coord Diff -693.2190 0.0026 10.2170
2001 2002 3-D Z-Coord Diff -891.5890 0.0025 -2.9070
2001 2002 3-D X-Coord Diff -286.6790 0.0026 -1.8260
2001 2002 3-D Y-Coord Diff -693.2230 0.0030 10.2210
2001 2002 3-D Z-Coord Diff -891.5780 0.0026 -2.9180
2014 2002 3-D X-Coord Diff 3799.0050 0.0129 3.0292
2014 2002 3-D Y-Coord Diff 2554.0180 0.0101 19.6183
2014 2002 3-D Z-Coord Diff 5296.7980 0.0113 -12.0600
2013 2001 3-D X-Coord Diff 718.2440 0.0059 4.8628
2013 2001 3-D Y-Coord Diff -4643.7750 0.0083 9.3965
2013 2001 3-D Z-Coord Diff -4222.2870 0.0059 -9.1487
FORMEQ successfully completed.
-----
GeoLab - V1.82S, (C) 1985/86/87 BitWise Ideas Inc. [103207696] Page 4

```

Figure F-12b. GEOLAB Adjustment Output (Constrained)

```

-----
                U.S. ARMY ENGINEER TOPOGRAPHIC LABORATORIES
                COYOTE DAM ADJUSTMENT NAD-83
A= 6378137.000 B= 6356752.314 X0= 0.000 Y0= 0.000 Z0= 0.000
-----
SOLVE:      Solution (Iteration Count = 1):
CODE IDENT.  TYPE              INITIAL              DX              UPDATED
-----
24 2001      LATITUDE    39 12 14.43422      0.01413      39 12 14.44836
24 2001      LONGITUDE  -123 11 6.45941      0.04476     -123 11 6.41465
24 2001      HEIGHT           243.86577      13.93968           257.80545

24 2002      LATITUDE    39 11 37.00656     -0.06729     39 11 36.93927
24 2002      LONGITUDE  -123 11 0.94286     0.34171     -123 11 0.60115
24 2002      HEIGHT           243.88154     21.63406           265.51561

94 WGSXX     3DD SCAL           0.00000     -0.00161           -0.00161
94 WGSXX     3DD ROTX           0.00000     0.03270            0.03270
94 WGSXX     3DD ROTY           0.00000     -0.06406           -0.06406
94 WGSXX     3DD ROTZ           0.00000     -0.04338           -0.04338
SOLVE successfully completed.
-----
Geolab - V1.82S, (C) 1985/86/87 BitWise Ideas Inc. [103207696]      Page 5
-----
FORMER:      FORMER successfully completed.
-----
Geolab - V1.82S, (C) 1985/86/87 BitWise Ideas Inc. [103207696]      Page 6
-----
SOLVE:      Adjusted Values (Iteration Count = 2):
CODE IDENT.  TYPE              INITIAL              DX              ADJUSTED
-----
14 2006      LATITUDE    39 11 34.37462           FIXED
14 2006      LONGITUDE  -123 10 10.28988           FIXED
14 2006      HEIGHT           336.08500           FIXED

14 2013      LATITUDE    39 15 12.11624           FIXED
14 2013      LONGITUDE  -123 13 17.48887           FIXED
14 2013      HEIGHT           222.83500           FIXED

14 2014      LATITUDE    39 7 57.41258           FIXED
14 2014      LONGITUDE  -123 12 14.77684           FIXED
14 2014      HEIGHT           190.17000           FIXED

24 2001      LATITUDE    39 12 14.44836      0.00000      39 12 14.44836
24 2001      LONGITUDE  -123 11 6.41465      0.00000     -123 11 6.41465
24 2001      HEIGHT           257.80545     -0.00000           257.80545

24 2002      LATITUDE    39 11 36.93927      0.00000     39 11 36.93927
24 2002      LONGITUDE  -123 11 0.60115     -0.00000     -123 11 0.60115
24 2002      HEIGHT           265.51561      0.00000           265.51561

94 WGSXX     3DD SCAL           -0.00161      0.00000           -0.00161
94 WGSXX     3DD ROTX           0.03270     -0.00000            0.03270
94 WGSXX     3DD ROTY           -0.06406      0.00000           -0.06406
94 WGSXX     3DD ROTZ           -0.04338      0.00000           -0.04338
-----
Geolab - V1.82S, (C) 1985/86/87 BitWise Ideas Inc. [103207696]      Page 7

```

Figure F-12c. GEOLAB Adjustment Output (Constrained)

U.S. ARMY ENGINEER TOPOGRAPHIC LABORATORIES
COYOTE DAM ADJUSTMENT NAD-83

A= 6378137.000 B= 6356752.314 X0= 0.000 Y0= 0.000 Z0= 0.000

Adjusted Cartesian Coordinates:

CODE IDENT.	X-COORDINATE	Y-COORDINATE	Z-COORDINATE
24 2001	-2708947.0978	-4142053.2284	4010056.1788
24 2002	-2709233.7715	-4142746.4512	4009164.5972

SOLVE successfully completed.

GeoLab - V1.82S, (C) 1985/86/87 BitWise Ideas Inc. [103207696] Page 8

INVERT: INVERT successfully completed.

GeoLab - V1.82S, (C) 1985/86/87 BitWise Ideas Inc. [103207696] Page 9

RESID:

STATION	3-D COORD DIFFS	STD.DEV.	RESIDUAL	STD.DEV.	STAN.RES.
2001	-2708942.2350 -4142043.8310 4010047.0300				
2006	-2708275.6180 -4143485.3790 4009138.7500	0.0050 0.0060 0.0040	0.0020 0.0043 -0.0055	0.0041 0.0045 0.0026	0.4865 0.9530 -2.1060
===== End of Observation Set =====					
2002	-2709230.7400 -4142726.8330 4009152.5340				
2006	-2708277.4450 -4143475.1510 4009135.8240	0.0030 0.0050 0.0040	-0.0024 -0.0031 0.0063	0.0016 0.0032 0.0026	-1.5309 -0.9650 2.3907
===== End of Observation Set =====					
2001	-2708941.0950 -4142050.6320 4010040.8370				
2002	-2709227.7640 -4142743.8510 4009149.2480	0.0030 0.0040 0.0040	-0.0046 -0.0036 0.0072	0.0020 0.0031 0.0032	-2.2625 -1.1706 2.2786
===== End of Observation Set =====					
2001	-2708946.1080 -4142048.2180 4010039.9500				
2002	-2709232.7870 -4142741.4410 4009148.3720	0.0040 0.0040 0.0040	0.0054 0.0004 -0.0038	0.0033 0.0031 0.0032	1.6090 0.1285 -1.1993
===== End of Observation Set =====					
2014	-2713050.5170 -4145286.8310 4003867.5850				
2002	-2709251.5120 -4142732.8130 4009164.3830	0.0180 0.0160 0.0200	-0.0035 -0.0015 0.0047	0.0149 0.0090 0.0141	-0.2328 -0.1659 0.3373
===== End of Observation Set =====					
2013	-2709663.6000 -4137421.4500 4014263.6620				
2014	-2713031.0290 -4145312.4700 4003852.9890	0.0150 0.0460 0.0330	-0.0018 0.0055 0.0010	0.0105 0.0419 0.0293	-0.1739 0.1303 0.0344

GeoLab - V1.82S, (C) 1985/86/87 BitWise Ideas Inc. [103207696] Page 10

Figure F-12d. GEOLAB Adjustment Output (Constrained)

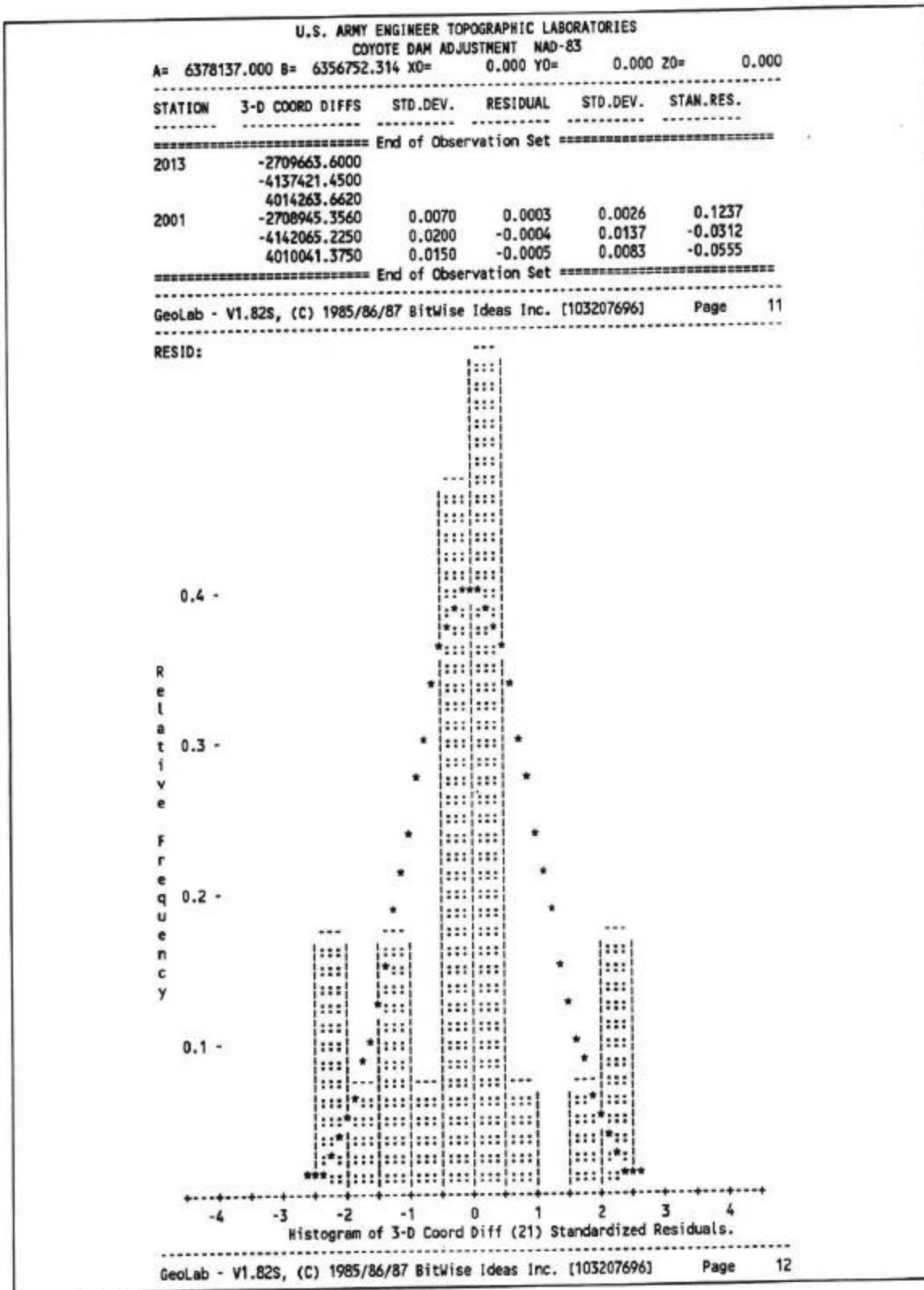

Figure F-12e. GEOLAB Adjustment Output (Constrained)

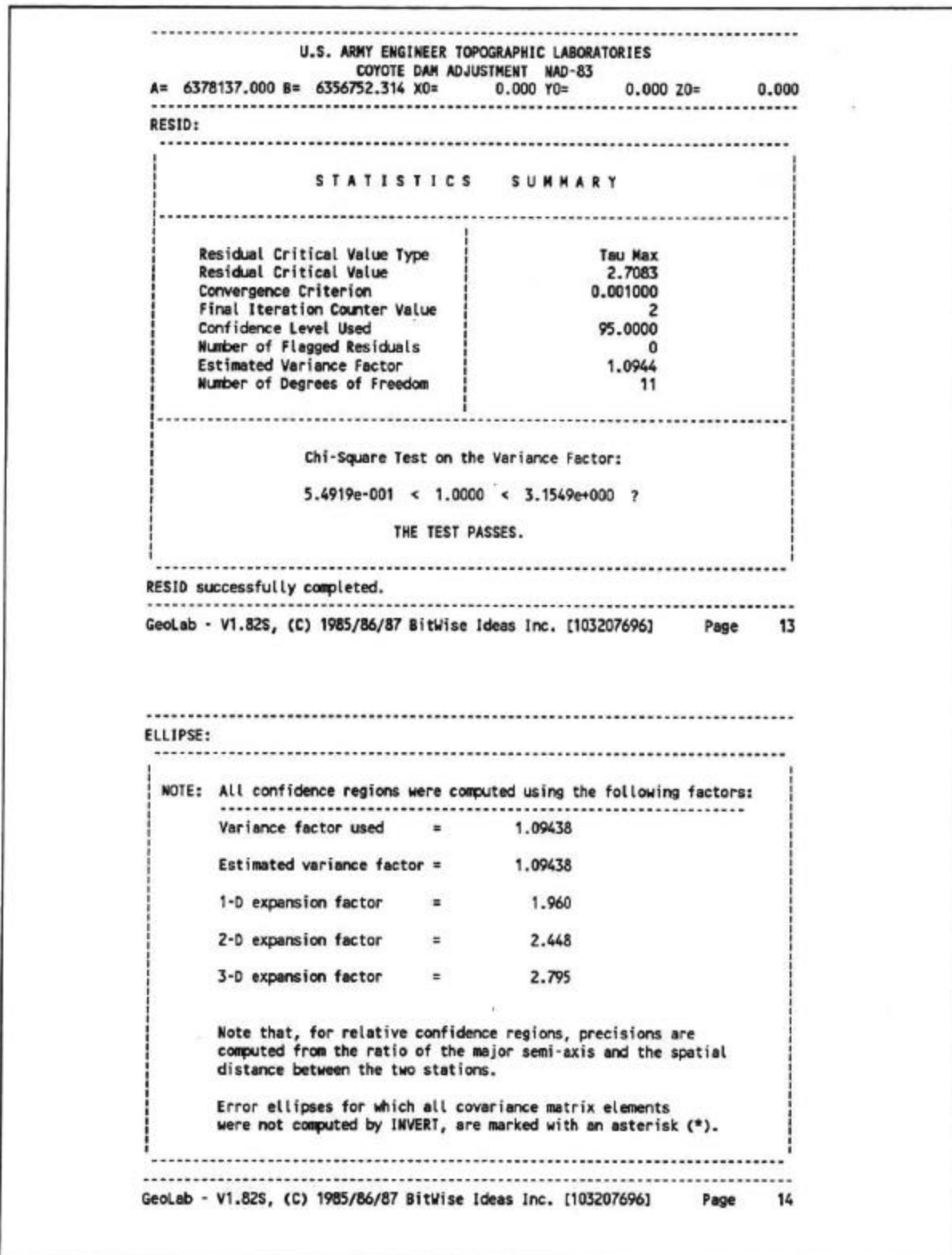

Figure F-12f. GEOLAB Adjustment Output (Constrained)

```

-----
                                U.S. ARMY ENGINEER TOPOGRAPHIC LABORATORIES
                                COYOTE DAM ADJUSTMENT NAD-83
A= 6378137.000 B= 6356752.314 X0= 0.000 Y0= 0.000 Z0= 0.000
-----
ELLIPSE:                AUXILIARY PARAMETER CONFIDENCE INTERVALS ( 95.000 %):
-----
IDENT.  TYPE  CLASS  ADJ VALUE  1.96 SIGMA
-----
WGSXX  300  SCAL  -0.0016  1.1261
        ROTX  0 0  0.03  0 0  0.82
        ROTY  0 0 -0.06  0 0  1.27
        ROTZ  0 0 -0.04  0 0  1.37
-----
GeoLab - V1.82S, (C) 1985/86/87 BitWise Ideas Inc. [103207696]  Page 15
-----

```

```

-----
ELLIPSE:                2-D AND 1-D STATION CONFIDENCE REGIONS ( 95.000 %):
-----
IDENT.  MAJOR SEMI-AXIS  MINOR SEMI-AXIS  AZ(MAJ)  VERTICAL
-----
2001  0.0066  0.0048  107.22  0.0133
2002  0.0062  0.0044  125.62  0.0127
-----
GeoLab - V1.82S, (C) 1985/86/87 BitWise Ideas Inc. [103207696]  Page 16
-----

```

```

-----
ELLIPSE:                2-D AND 1-D RELATIVE STATION CONFIDENCE REGIONS ( 95.000 %):
-----
FROM  TO  MAJ.SEMI  MIN.SEMI  AZ(MAJ)  VERTICAL  SPATIAL DIST.  PRECISION
-----
2001  2002  0.0045  0.0036  108.07  0.0082  1165.1856  3.846 PPM
-----
GeoLab - V1.82S, (C) 1985/86/87 BitWise Ideas Inc. [103207696]  Page 17
-----

```

```

-----
ELLIPSE:                3-D STATION CONFIDENCE REGIONS ( 95.000 %):
-----
IDENT.  MAJOR SEMI-AXIS  MEDIUM SEMI-AXIS  MINOR SEMI-AXIS
-----
2001  0.0191  0.0070  0.0056
        A=106.6 V= 81.9  A=270.0 V= 7.8  A= 0.3 V= 2.3
2002  0.0182  0.0070  0.0051
        A= 90.0 V= 87.6  A=306.2 V= 1.9  A=216.2 V= 1.4
-----
GeoLab - V1.82S, (C) 1985/86/87 BitWise Ideas Inc. [103207696]  Page 18
-----

```

```

-----
ELLIPSE:                3-D RELATIVE STATION CONFIDENCE REGIONS ( 95.000 %):
-----
FROM  TO  MAJOR-SEMI  MED.-SEMI  MINOR-SEMI  SPATIAL DIST.  PRECISION
-----
2001  2002  0.0117  0.0050  0.0042  1165.1856  10.027 PPM
        A= 0 V=90 A= 90 V= 0 A= 0 V= 0
ELLIPSE successfully completed.
-----
GeoLab - V1.82S, (C) 1985/86/87 BitWise Ideas Inc. [103207696]  Page 19
-----

```

Figure F-12g. GEOLAB Adjustment Output (Constrained)

Appendix G

Application: Structural Deformation Reference Network Survey--Dworshak Dam, Idaho (Walla Walla District and Topographic Engineer Center)

G-1. General

High precision GPS control surveys may be performed to establish reference locations for structural deformation monitoring surveys. Accurate reference control in the vicinity of the structure is critical. Absolute NGRS coordinate on monitoring points is of lesser importance. NGRS control may be brought into one of the reference points with GPS. Only the NGRS coordinates of this fixed point are held fixed for all subsequent adjustments in the vicinity of the structure.

G-2. Project Description

This project was conducted in the vicinity of Dworshak Dam, Idaho and was performed to establish permanent reference points in the vicinity of the dam. A diagram of the project is shown in Figure G-1. Baseline data from the NGRS control to one point (Fish Hatchery - 4001) at the project site were collected and other baseline data for baselines between 4001, BIG EDDY (4002), and four points on the Dworshak Dam and Reservoir (4003, 4004, 4005, and 4006) as shown in Figure G-1. Loop closure checks were done for the complete network by using the loop closure routine shown in Figure G-2. The resultant precision for the loop is 0.43 ppm (1:2,300,000).

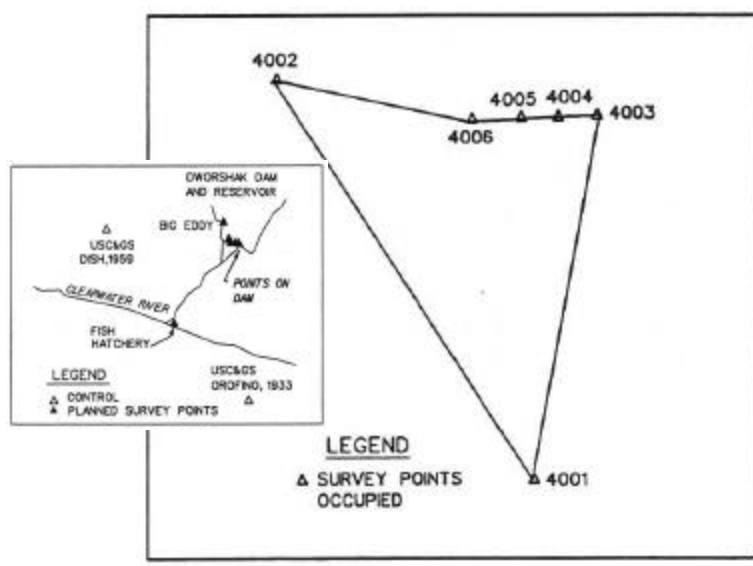

Figure G-1. Dworshak Dam locale and GPS project diagram

G-3. Adjustment

An IOB file for the adjustment based on the formulated baselines was set up. Station USC&GS Dish, 1959, and USC&GS Orofino, 1933, were held fixed to establish NGRS control on Corps of Engineers Station 4001 at the project site. Then, for the next adjustment, 4001 was held fixed to adjust station 4002, 4003, 4004, 4005, and 4006. The resultant adjustment statistics are shown in Figure G-3 (a-h). The 2-D station confidence is on the order of 0.04 m (95%) in the horizontal and ± 0.06 m in the vertical. The largest line accuracy is 36.322 ppm (1:27,000) over a short (62 meter) baseline. This would be acceptable even though a 1:100,00 relative accuracy is required. Due to fixed centering errors, maintaining 1:100,000 relative accuracies over lines less than 200 to 500 meters is unrealistic.

Trimble Loop Closure Utility			
Start Traverse at Station: 4006			
Starting Coords :	46x30'56.88832"ON	116x17'48.33684"OW	489.943
Baseline 1			
File Name:	06053001.FIX		
From Station:	4006	To Station:	4005
Distance Travelled (m):	82.829		
Current Coords :	46x30'55.20552"ON	116x17'46.75486"OW	500.412
Baseline 2			
File Name:	05042993.FIX		
From Station:	4005	To Station:	4004
Distance Travelled (m):	124.262		
Current Coords :	46x30'54.30015"ON	116x17'44.23756"OW	489.809
Baseline 3			
File Name:	04032991.FIX		
From Station:	4004	To Station:	4003
Distance Travelled (m):	214.384		
Current Coords :	46x30'51.68841"ON	116x17'42.38493"OW	497.376
Baseline 4			
File Name:	01032992.FIX		
From Station:	4003	To Station:	4001
Distance Travelled (m):	2872.755		
Current Coords :	46x30'05.98861"ON	116x19'27.67811"OW	308.887
Baseline 5			
File Name:	01023012.FIX		
From Station:	4001	To Station:	4002
Distance Travelled (m):	8122.940		
Current Coords :	46x31'41.48032"ON	116x18'24.06337"OW	490.036
Baseline 6			
File Name:	02063001.FIX		
From Station:	4002	To Station:	4006
Distance Travelled (m):	7695.981		
Current Coords :	46x30'56.88826"ON	116x17'48.33690"OW	489.941
End Traverse at Station: 4006			
Distance Travelled (m):	7695.981	Precision (ppm):	0.43
dx:	-0.001	dy:	0.001
		dz:	-0.003
		dh:	-0.002
Ending Coords :	46x30'56.88826"ON	116x17'48.33690"OW	489.941
Reference Coords:	46x30'56.88832"ON	116x17'48.33684"OW	489.943

Figure G-2. Loop Closure (Dworshak)

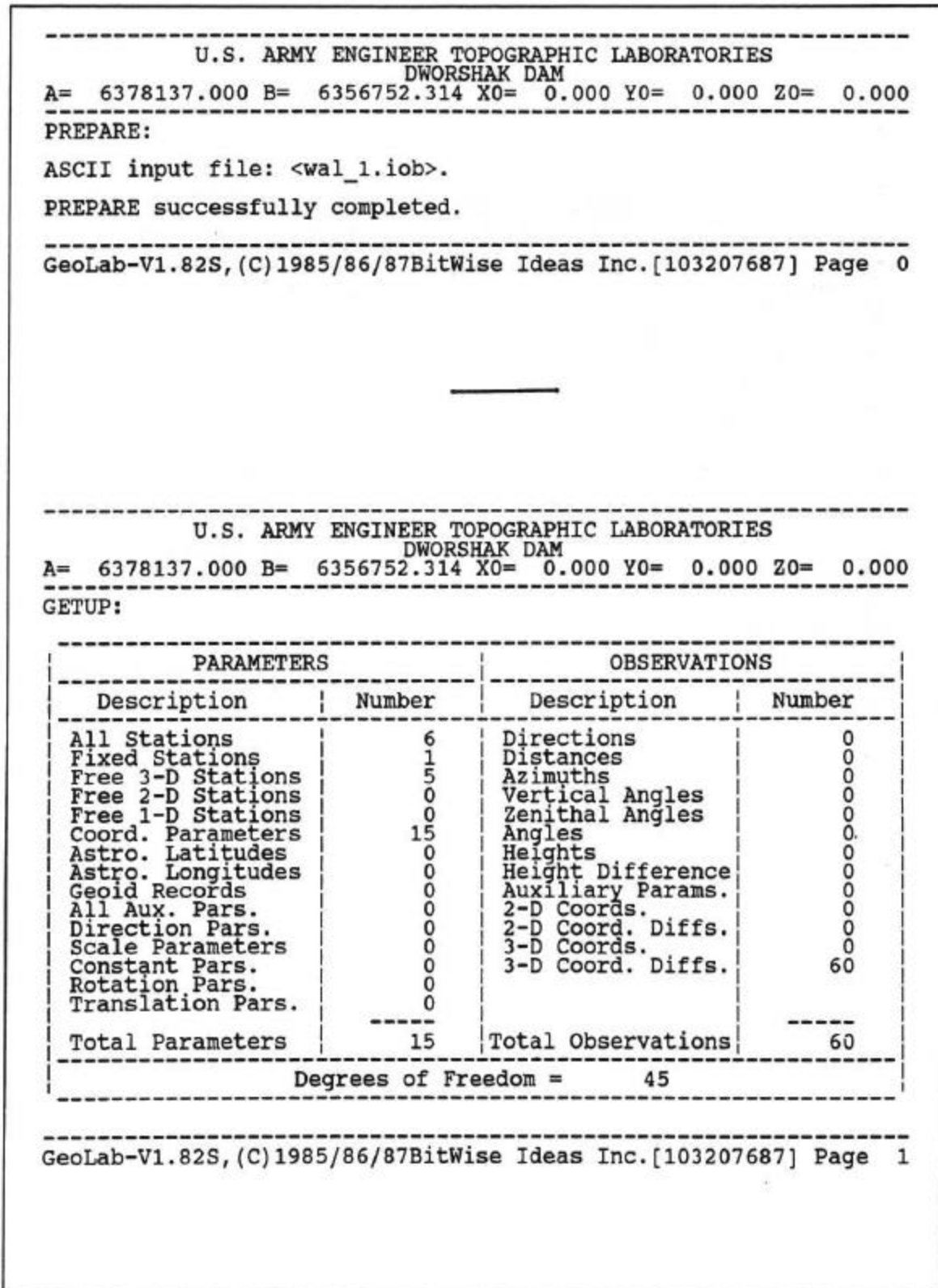

Figure G-3a. GEOLAB adjustment output (Dworshak Dam Reference Network)

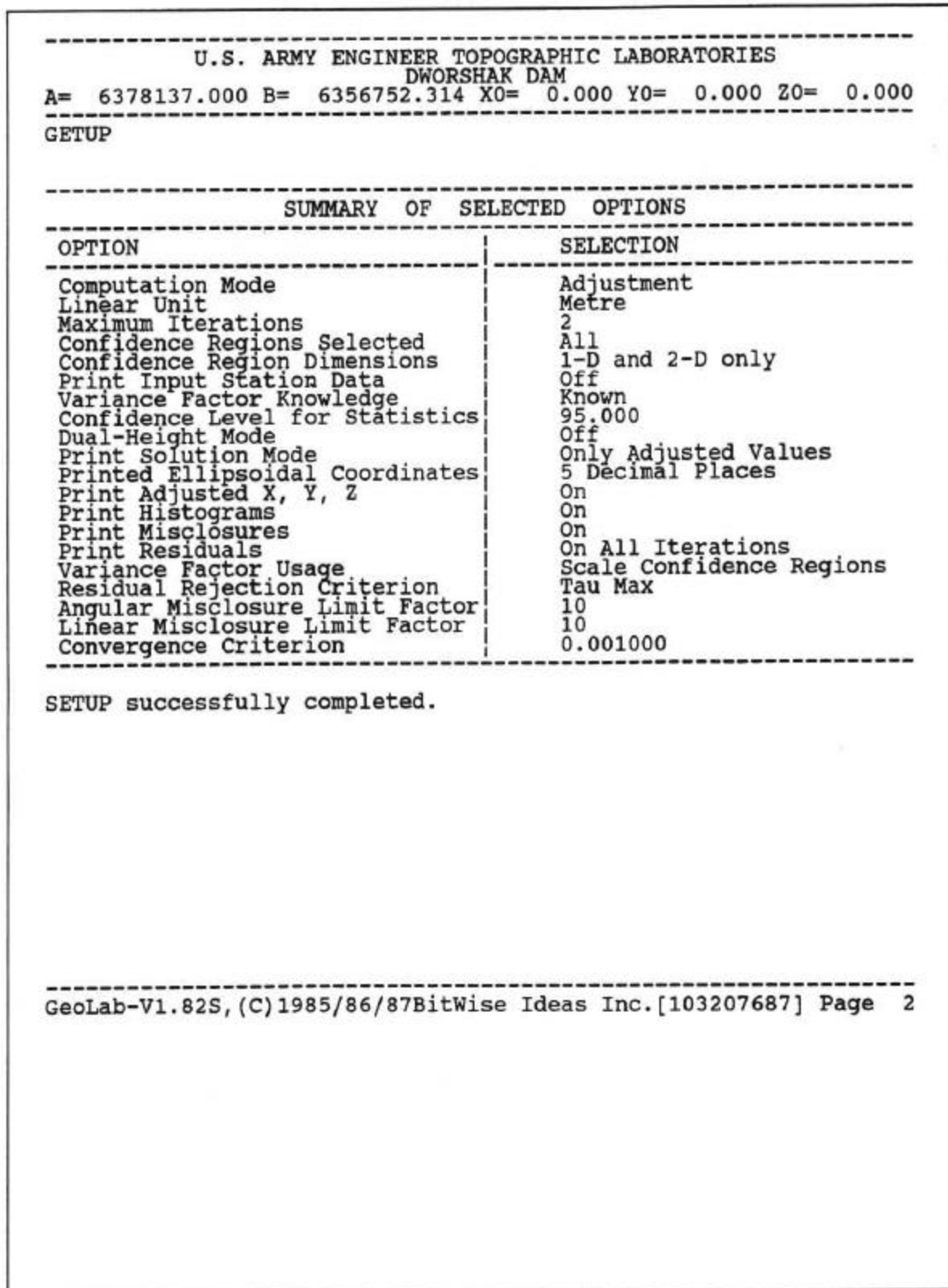

Figure G-3b. GEOLAB adjustment output (Dworshak Dam Reference Network)

U.S. ARMY ENGINEER TOPOGRAPHIC LABORATORIES						
DWORSHAK DAM						
A= 6378137.000		B= 6356752.314		X0= 0.000	Y0= 0.000	Z0= 0.000
FORMEQ:						
NOTE 6: Reordering was done.						
AT	TO	OBS	TYPE	OBSERVATION	APPROX. SIG.	MISCLOSURE
4001	4003	3-D	X-Coord Diff	2408.6880	0.0029	22.8708
4001	4003	3-D	Y-Coord Diff	-193.5840	0.0016	25.8258
4001	4003	3-D	Z-Coord Diff	1108.0180	0.0021	-26.6407
4004	4003	3-D	X-Coord Diff	7.1790	0.0007	22.7040
4004	4003	3-D	Y-Coord Diff	-74.6270	0.0003	21.7690
4004	4003	3-D	Z-Coord Diff	-50.0120	0.0006	-25.7900
4001	4004	3-D	X-Coord Diff	2401.5070	0.0055	.1688
4001	4004	3-D	Y-Coord Diff	-118.9530	0.0065	4.0528
4001	4004	3-D	Z-Coord Diff	1158.0230	0.0062	-0.8437
4001	4002	3-D	X-Coord Diff	2108.6340	0.0061	-1.6862
4001	4002	3-D	Y-Coord Diff	1204.4260	0.0079	36.7548
4001	4002	3-D	Z-Coord Diff	2160.2690	0.0067	-27.6797
4001	4003	3-D	X-Coord Diff	2408.6870	0.0055	22.8718
4001	4003	3-D	Y-Coord Diff	-193.5780	0.0072	25.8198
4001	4003	3-D	Z-Coord Diff	1108.0110	0.0062	-26.6337
4001	4005	3-D	X-Coord Diff	2359.1380	0.0047	-0.9472
4001	4005	3-D	Y-Coord Diff	-83.5390	0.0122	5.9208
4001	4005	3-D	Z-Coord Diff	1184.9630	0.0073	-7.2267
4005	4004	3-D	X-Coord Diff	42.3580	0.0008	1.1270
4005	4004	3-D	Y-Coord Diff	-35.4190	0.0015	-1.8630
4005	4004	3-D	Z-Coord Diff	-26.9330	0.0006	6.3760
4001	4002	3-D	X-Coord Diff	2108.6240	0.0045	-1.6762
4001	4002	3-D	Y-Coord Diff	1204.4190	0.0104	36.7618
4001	4002	3-D	Z-Coord Diff	2160.2710	0.0063	-27.6817
4001	4006	3-D	X-Coord Diff	2348.8140	0.0033	32.4128
4001	4006	3-D	Y-Coord Diff	-28.3330	0.0019	24.3928
4001	4006	3-D	Z-Coord Diff	1213.1260	0.0021	-23.8437
4006	4005	3-D	X-Coord Diff	10.3400	0.0008	-33.3760
4006	4005	3-D	Y-Coord Diff	-55.2020	0.0004	-18.4760
4006	4005	3-D	Z-Coord Diff	-28.1650	0.0007	16.6190
4002	4006	3-D	X-Coord Diff	240.1770	0.0031	34.1020
4002	4006	3-D	Y-Coord Diff	-1232.7570	0.0020	-12.3640
4002	4006	3-D	Z-Coord Diff	-947.1440	0.0019	3.8370
4002	4005	3-D	X-Coord Diff	250.5120	0.0027	0.7310
4002	4005	3-D	Y-Coord Diff	-1287.9560	0.0040	-30.8430
4002	4005	3-D	Z-Coord Diff	-975.3050	0.0031	20.4520
4001	4005	3-D	X-Coord Diff	2359.1440	0.0055	-0.9532
4001	4005	3-D	Y-Coord Diff	-83.5400	0.0067	5.9218
4001	4005	3-D	Z-Coord Diff	1184.9690	0.0063	-7.2327
4001	4006	3-D	X-Coord Diff	2348.8070	0.0054	32.4198
4001	4006	3-D	Y-Coord Diff	-28.3370	0.0066	24.3968
4001	4006	3-D	Z-Coord Diff	1213.1310	0.0062	-23.8487
4002	4003	3-D	X-Coord Diff	300.0520	0.0022	24.5590
4002	4003	3-D	Y-Coord Diff	-1398.0030	0.0043	-10.9360

Figure G-3c. GEOLAB adjustment output (Dworshak Dam Reference Network)

```

-----
                U.S. ARMY ENGINEER TOPOGRAPHIC LABORATORIES
                DWORSHAK DAM
A= 6378137.000 B= 6356752.314 X0= 0.000 Y0= 0.000 Z0= 0.000
-----
FORMEQ:

```

AT	T0	OBS TYPE	OBSERVATION	APPROX. SIG.	MISCLOSURE
4002	4003	3-D X-Coord Diff	-1052.2550	0.0024	1.0430
4006	4003	3-D X-Coord Diff	59.8780	0.0007	-9.5460
4006	4003	3-D Y-Coord Diff	-165.2500	0.0015	1.4320
4006	4003	3-D Z-Coord Diff	-165.2500	0.0006	-2.7900
4001	4002	3-D X-Coord Diff	2108.6250	0.0045	-1.6772
4001	4002	3-D Y-Coord Diff	1204.4170	0.0104	36.7638
4001	4002	3-D Z-Coord Diff	2160.2740	0.0063	-27.6847
4001	4002	3-D X-Coord Diff	2108.6270	0.0043	-1.6792
4001	4002	3-D Y-Coord Diff	1204.4160	0.0028	36.7648
4001	4002	3-D Z-Coord Diff	2160.2680	0.0029	-27.6787
4001	4002	3-D X-Coord Diff	2108.6320	0.0063	-1.6842
4001	4002	3-D Y-Coord Diff	1204.4280	0.0078	36.7528
4001	4002	3-D Z-Coord Diff	2160.2620	0.0062	-27.6727
4001	4002	3-D X-Coord Diff	2108.6250	0.0045	-1.6772
4001	4002	3-D Y-Coord Diff	1204.4170	0.0101	36.7638
4001	4002	3-D Z-Coord Diff	2160.2780	0.0061	-26.6887

```

FORMEQ successfully completed.
-----
GeoLab-V1.82S, (C)1985/86/87BitWise Ideas Inc. [103207687] Page 4
-----
                U.S. ARMY ENGINEER TOPOGRAPHIC LABORATORIES
                DWORSHAK DAM
A= 6378137.000 B= 6356752.314 X0= 0.000 Y0= 0.000 Z0= 0.000
-----
SOLVE:
SOLVE successfully completed.
-----
GeoLab-V1.82S, (C)1985/86/87BitWise Ideas Inc. [103207687] Page 5
-----
                U.S. ARMY ENGINEER TOPOGRAPHIC LABORATORIES
                DWORSHAK DAM
A= 6378137.000 B= 6356752.314 X0= 0.000 Y0= 0.000 Z0= 0.000
-----
FORMEQ:
FORMEQ successfully completed.
-----
GeoLab-V1.82S, (C)1985/86/87BitWise Ideas Inc. [103207687] Page 6
-----

```

Figure G-3d. GEOLAB adjustment output (Dworshak Dam Reference Network)

U.S. ARMY ENGINEER TOPOGRAPHIC LABORATORIES									
DWORSHAK DAM									
A=		6378137.000		B=		6356752.314		X0= 0.000 Y0= 0.000 Z0= 0.000	

SOLVE:									
Adjusted Values (Iteration Count = 2):									
CODE	IDENT.	TYPE	INITIAL			DX	ADJUSTED		
14	4001	LATITUDE	46	30	5.78733	FIXED			
14	2006	LONGITUDE	-116	19	17.36405	FIXED			
14	2006	HEIGHT			312.18200	FIXED			
24	4003	LATITUDE	46	30	51.48677	0.00000	46	30	51.48677
24	4003	LONGITUDE	-116	17	42.07099	0.00000	-116	17	42.07099
24	4003	HEIGHT			500.68216	0.00001			500.68217
24	4004	LATITUDE	46	30	54.09853	0.00000	46	30	54.09853
24	4004	LONGITUDE	-116	17	43.92366	-0.00000	-116	17	43.92366
24	4004	HEIGHT			493.11850	0.00000			493.11851
24	4002	LATITUDE	46	30	41.25876	0.00000	46	31	41.25876
24	4002	LONGITUDE	-116	18	23.74916	-0.00001	-116	18	23.74917
24	4002	HEIGHT			493.34210	0.00003			493.34213
24	4005	LATITUDE	46	30	55.00394	-0.00000	46	30	36.93927
24	4005	LONGITUDE	-116	17	46.44097	-0.00000	-116	17	46.44097
24	4005	HEIGHT			503.72111	0.00000			503.72111
24	4006	LATITUDE	46	30	56.68676	0.00000	46	30	56.68676
24	4006	LONGITUDE	-116	17	48.02294	0.00001	-116	17	48.02294
24	4006	HEIGHT			493.25364	0.00003			493.25367

GeoLab-V1.82S, (C)1985/86/87BitWise Ideas Inc. [103207687] Page 7									

U.S. ARMY ENGINEER TOPOGRAPHIC LABORATORIES									
DWORSHAK DAM									
A=		6378137.000		B=		6356752.314		X0= 0.000 Y0= 0.000 Z0= 0.000	

Adjusted Cartesian Coordinates:									
CODE	IDENT.	X-COORDINATE			Y-COORDINATE			Z-COORDINATE	
24	4003	-1948002.5548			-3942346.3361			4605137.8787	
24	4004	-1948009.7358			-3942271.7102			4605187.8935	
24	4002	-1948302.6080			-3940948.3316			4606190.1331	
24	4005	-1948052.0934			-3942236.2903			4605213.8271	
24	4006	-1948062.4335			-3942181.0887			4605242.9935	
SOLVE successfully completed.									

GeoLab-V1.82S, (C)1985/86/87BitWise Ideas Inc. [103207687] Page 8									

U.S. ARMY ENGINEER TOPOGRAPHIC LABORATORIES									
DWORSHAK DAM									
A=		6378137.000		B=		6356752.314		X0= 0.000 Y0= 0.000 Z0= 0.000	

INVERT:									
INVERT successfully completed.									

GeoLab-V1.82S, (C)1985/86/87BitWise Ideas Inc. [103207687] Page 9									

Figure G-3e. GEOLAB adjustment output (Dworshak Dam Reference Network)

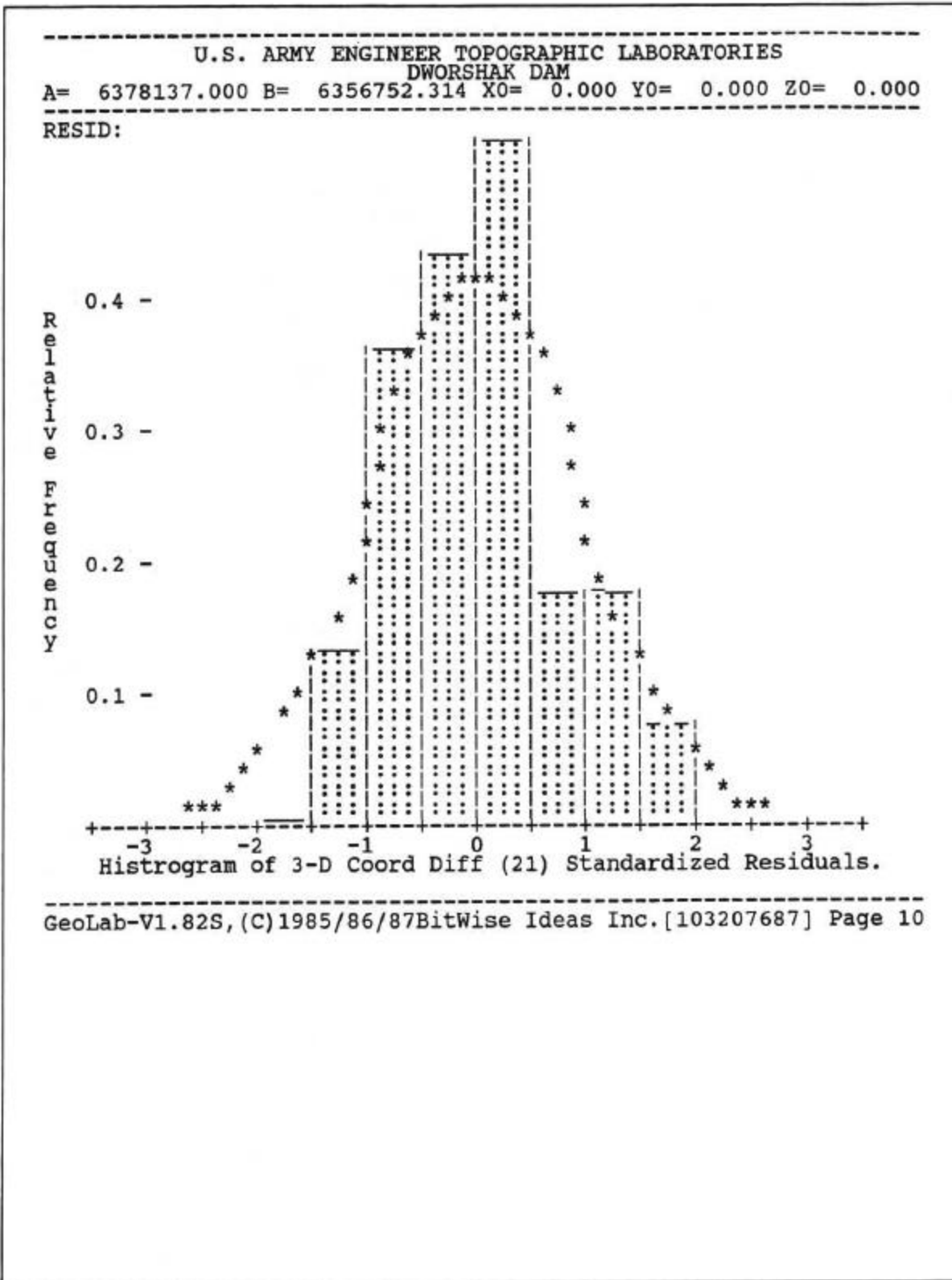

Figure G-3f. GEOLAB adjustment output (Dworshak Dam Reference Network)

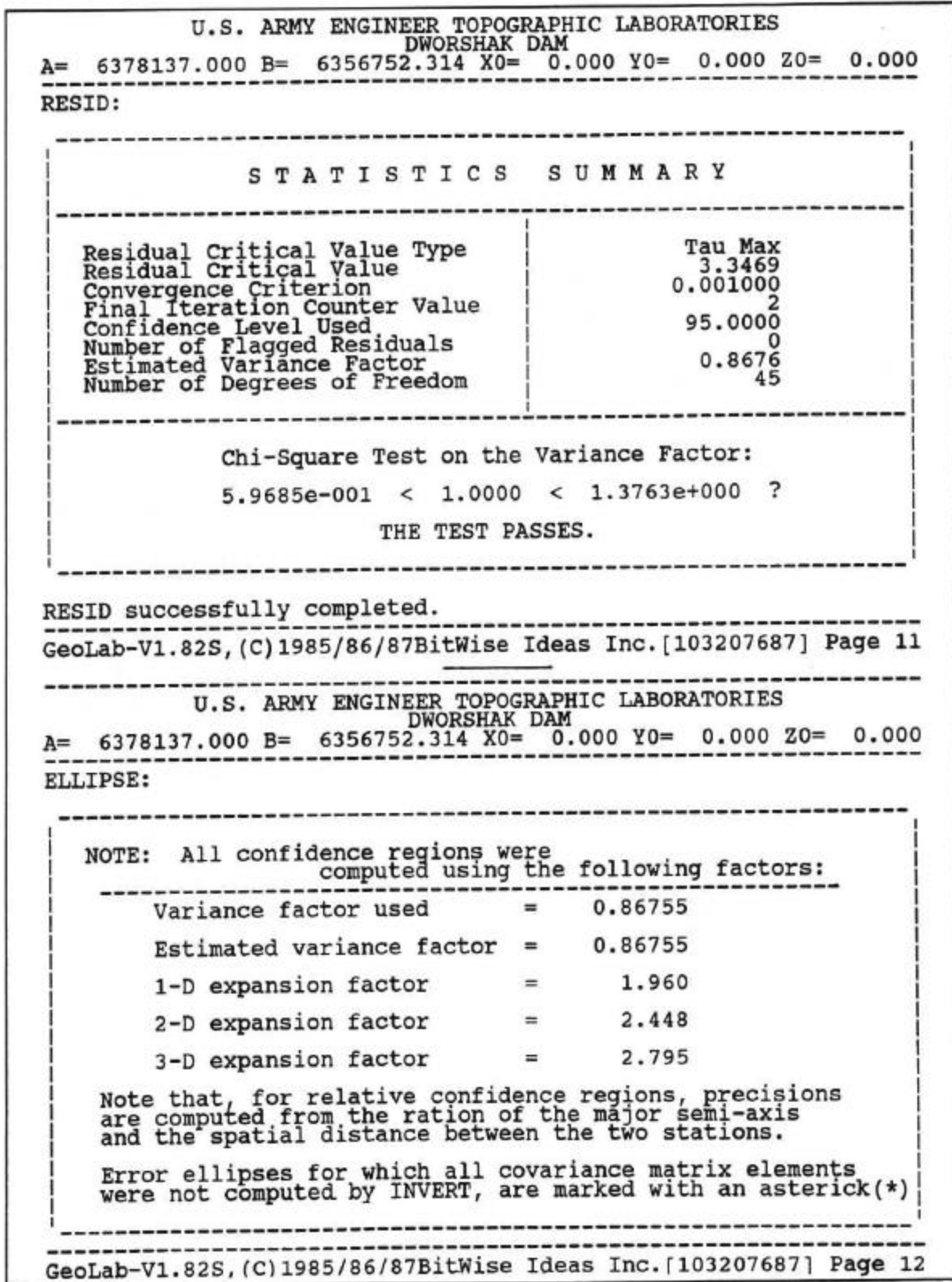

Figure G-3g. GEOLAB adjustment output (Dworshak Dam Reference Network)

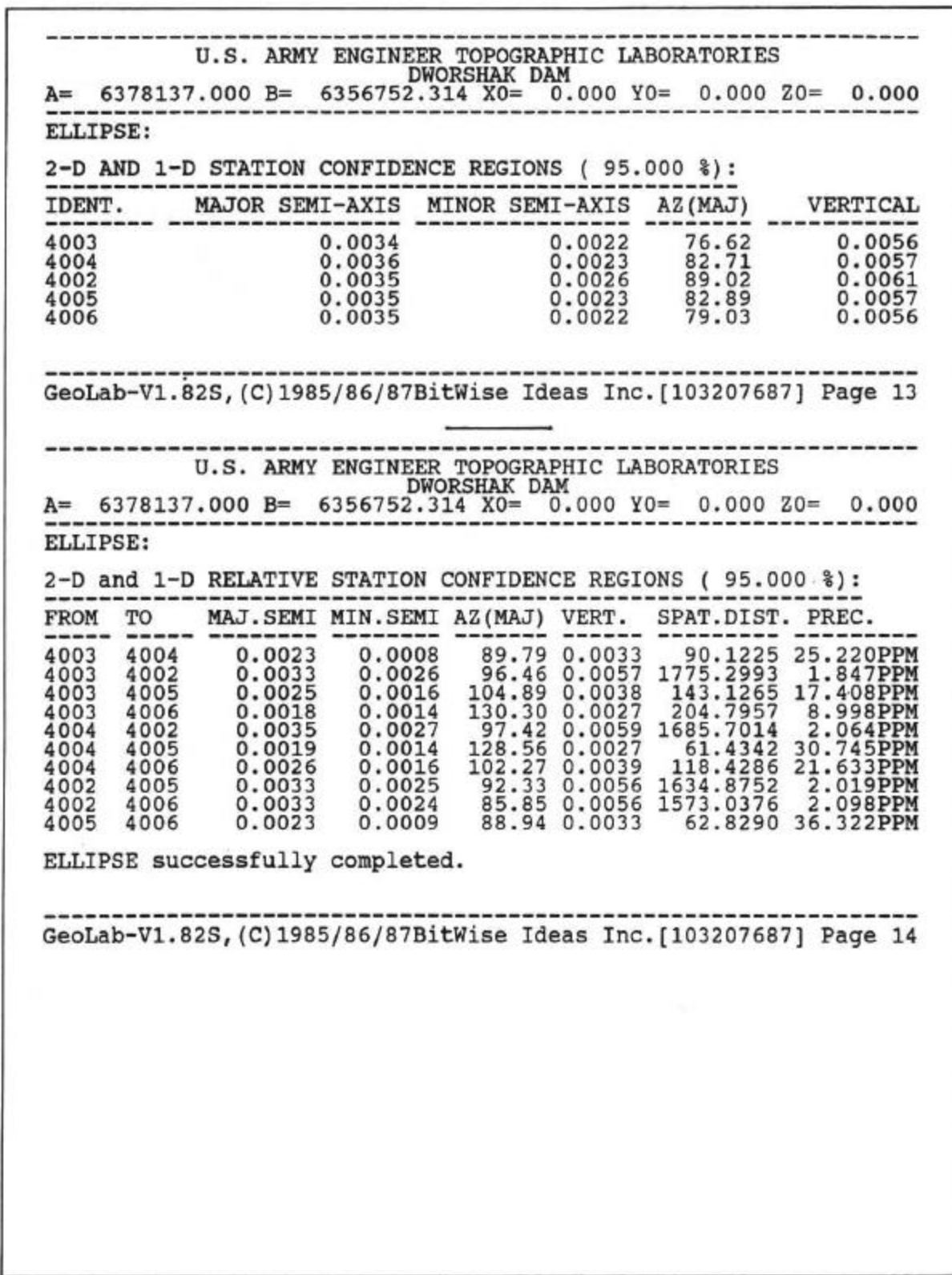

Figure G-3h. GEOLAB adjustment output (Dworshak Dam Reference Network)

Appendix H

Application: Upper Saginaw River, MI Navigation Project--Second-Order GPS Photo Mapping Control Surveys (Detroit District)

The purpose of this 1993 project was to establish Second-Order control, using static GPS survey methods, for the navigation project on the Upper Saginaw River (Michigan) leading into Saginaw Bay in Lake Huron. The survey area started at Green Point and went to the railroad bridge at the upper end of the project area. Control stations established during this survey were designed to support digital mapping of the Upper Saginaw River. A total of 8 stations in the project area were occupied, and 6 new stations were established. External NGRS control was brought in from two First-Order NGS horizontal control stations--JONAS and PARRISH. The Saginaw Area Office, Detroit District, performed all the observations and adjustments. This appendix illustrates the observation, reduction, and adjustment phases of this project.

H-1. Planning Phase

- a. The GPS survey was planned for 24-25 March 1993, Julian Day 083 and 084 in the vicinity of Saginaw, Michigan.
- b. Four Ashtech Dual Frequency (L1/L2) GPS receivers and antennas with ground planes were used for this project, simultaneously occupying 4 stations during each session--observing 6 baselines, 3 of which are independent.
- c. Prior to any data collection, a preplanning survey was conducted to determine any obstructions (see typical example in Figure H-1) and examine existing control. Control station JONAS and PARRISH had some sinking problems due to thawing ground. Station JONAS was readjusted during the survey but station PARRISH was not.
- d. A satellite visibility chart was run to determine occupation times for each session on both Day 083 and Day 084. The chart included the number of satellites and PDOP for the project area. The charts were run with an elevation mask of 20 deg (Figure H-2) and 25 deg (see Figure H-3).
- e. There were three survey sessions held on Day 083 and one on Day 084. Below are listed sessions, occupation times and stations occupied for Day 083 and Day 084.

Day 083			Day 084
Session A 0900-1000	Session B 1030-1130	Session C 1340-1540	Session A 1335-1535
HOYT GENESSEE HOLLAND EWALD	WICKES RUST HOLLAND EWALD	WICKES RUST JONAS PARRISH	HOYT GENESSEE JONAS PARRISH

H-2. Actual Survey

The survey was performed as planned, with three sessions on Day 083 and one session on Day 084. An Observation Log for each station was recorded by the observer. This information was used during post-processing.

H-3. Data Processing and Adjustment

a. The GPS baselines were processed using Ashtech baseline reduction software LINECOMP (GPPS-L, Version 4.5). All four sessions were processed. A typical output file from this program is shown in figure H-4 (a-e). From these results, session 083 A & B and 084 seemed to be satisfactory. Session 083 C tagged all the float solutions except for the vector between 4008 and 4009. The plots for these vectors, between 4008 and 4009, appeared to have been effected by the ionosphere.

b. After baseline processing was completed, a loop closure was performed--see typical output in Figure H-5--and one was performed to show closures between the unknown control stations.

c. Once the loop closures were completed, a FILLNET (Version 3.0) free adjustment and constrained adjustment was performed on all processed baselines for Julian days 083 and 084. Data shown in Figure H-6 is typical of the input file used for the free adjustment. The constrained adjustment held fixed station PARRISH (in X-Y-Z) and station JONAS (in X-Y). The results of the constrained adjustment are shown in Figure H-7 (a-f).

d. After the final adjustment of the data, CORPSCON was used to convert the station latitude, longitude to NAD 1983 SPCS coordinates. A sample output is shown in Figure H-8.

H-4. Station Descriptions

Station descriptions with adjusted coordinates for each control station set were formulated. A sample description is shown in Figure H-9.

" G.P.S. PREPLANNING SURVEY "

PROJECT: UPPER SAGINAW

STATION NAME: HOYT RIGHT OF ENTRY YES DATE: _____

HORIZONTAL CONTROL: KNOWN _____ UNKNOWN (IF UNKNOWN GIVE APPROX. LAT/LONG)

IF KNOWN GIVE VALUES: DATUM _____ PROJECTION _____ ZONE _____

LATITUDE _____ NORTH _____

LONGITUDE _____ EAST _____

VERTICAL CONTROL: KNOWN _____ UNKNOWN (IF UNKNOWN GIVE APPROX. ELEV.)

IF KNOWN GIVE VALUES: DATUM _____ ELEV. FT. _____ METERS _____

OBSERVATION SITE: COMPLETE OBSTRUCTION POLAR MAP (SEE BELOW)

ACCESSABILITY: CAR/TRUCK HIKE _____ BOAT

DISTANCE VEHICLE CAN BE PARKED TO STATION: _____

PRIVATE PROPERTY _____ PUBLIC PROPERTY KEY FOR GATE REQUIRED _____

NOTIFICATION OF PROPERTY OWNER REQUIRED PRIOR TO ACCESS NO

NAME: SAG. RIVER WALK IF YES PHONE # _____

OBSTRUCTION POLAR MAP:

INDICATE OBSTRUCTIONS;
EX. TREES, BUILDINGS, ...
(SEE EXAMPLE ON BACK)

REMARKS:

The diagram is a polar map with concentric circles representing distance from the station (0 to 300 feet) and radial lines representing bearings (0 to 330 degrees). Handwritten annotations include: 'Building' with an arrow pointing to a radial line at approximately 30 degrees; 'PIP 30°' with an arrow pointing to a radial line at approximately 90 degrees; and 'PIP 20°' with an arrow pointing to a radial line at approximately 180 degrees. The cardinal directions N, S, E, and W are marked.

Figure H-1. Preplanning survey diagram for station HOYT (Upper Saginaw River Project)

```

Ashtech, Inc. GPPS-L                Program: LINECOMP                Version: 4.5.00
                                     Fri Mar 26 10:34:33 1993

Project information
GPS Survey                          |25-character project name [ The | is in column 26
. ]
0843A                               |5-character session name
Project information

Known-station parameters
00                                  |Receiver identifier used in "LOGTIMES" file
000000                             |Project station number
1001                               |4-character short name
FIXED STATION                      |25-character long name
503 003 005 _____             |25-character comment field
0                                   |Position extraction (0=below,1=U-file,2=proj. file
)
N 43 33 32.67131                  |Latitude deg-min-sec (g=good;b=bad)
E 276 11 32.13854                 |E-Longitude deg-min-sec (g=good;b=bad)
W 83 48 27.86146                 |W-Longitude deg-min-sec (g=good;b=bad)
150.7356                          |Ellipsoidal height (m) (g=good;b=bad)
0.0000                            |North antenna offset(m)
0.0000                            |East antenna offset (m)
1.6990 0.1150 0.0000             |Vert antenna offset (m): slant/radius/added_offset
20.0                              |Temperature (degrees C)
50.0                              |Humidity (percent)
1010.0                            |Pressure (millibars)
U1001A93.084                      |Measurement filename (restricted to 24 characters)

Known-station parameters

Unknown-station parameters
00                                  |Receiver identifier used in "LOGTIMES" file
000000                             |Project station number
4005                               |4-character short name
UNKNOWN STATION                   |25-character long name
504 004 007 _____             |25-character comment field
0                                   |Position extraction (0=below,1=U-file,2=proj. file
)
N 43 26 1.65174                   |Latitude deg-min-sec (g=good;b=bad)
E 276 3 25.93899                 |E-Longitude deg-min-sec (g=good;b=bad)
W 83 56 34.06101                 |W-Longitude deg-min-sec (g=good;b=bad)
149.5289                          |Ellipsoidal height (m) (g=good;b=bad)
0.0000                            |North antenna offset(m)
0.0000                            |East antenna offset (m)
1.6350 0.1150 0.0000             |Vert antenna offset (m): slant/radius/added_offset
20.0                              |Temperature (degrees C)
50.0                              |Humidity (percent)
1010.0                            |Pressure (millibars)
U4005A93.084                      |Measurement filename (restricted to 24 characters)

Unknown-station parameters

```

Figure H-4a. Ashtech LINECOMP baseline reduction output file (Baseline 1001-4004)

```
Run-time parameters
  1                               First epoch to process
 -1                               Final epoch to process (-1 = last available)
20.0                             Elevation cutoff angle (degrees)
  1                               Data to process (0=Wdln;1=L1;2=L2;3=L1c;6=RpdSt)
0.010000                         Convergence criterion (meters)
00 00 00 00 00 00 00           Omit these satellites (up to 7)
 10                               Maximum iterations for tlsq and dlsq
00 00 00 00 00 00 00           Forbidden reference SVs (up to 7)
yes                               Apply tropo delay correction
Run-time parameters

LINECOMP 4.5.00 12/11/92

FIXED U-File from L1 only receiver.
UNKWN U-File from L1 only receiver.

FIXED U-File used BROADCAST orbits.
UNKWN U-File used BROADCAST orbits.

Common start of two UFILES: 1993/03/25 18:35:60.00
Common end   of two UFILES: 1993/03/25 20:32:60.00
  Selected first epoch: 1
  Selected last  epoch: 352
For SV 11 there are  221 triple-difference measurements.
For SV 18 there are  351 triple-difference measurements.
For SV 19 there are  351 triple-difference measurements.
For SV 27 there are   73 triple-difference measurements.
For SV 28 there are  348 triple-difference measurements.
For SV 29 there are  338 triple-difference measurements.
Epoch interval (seconds): 20.000000

THE TRIPLE DIFFERENCE SOLUTION (L1)
Measure of geometry: 0.640415
num_meas = 1329          num_used = 1323          rms_resid = 0.002595(m)
Post-Fit Chisq = 3459.383  NDF = 12.250

  Sigmax (m):  0.870234
  Sigmay (m):  0.572256
  Sigmaz (m):  0.270963
  x      y      z
x 1.00
y 0.71y 1.00
z-0.40z-0.59z 1.00

del_station: 0.005074 0.001394 -0.000650
  Station1: FIXED STATION          Station2: UNKNOWN STATION

          (00000)  (1001)          (00000)  (4005)
```

Figure H-4b. Ashtech LINECOMP baseline reduction output file (Baseline 1001-4004)

```

Latitude: 43.55907536 43 33 32.67131          43.43379221 43 26 1.65195
E-Long  : 276.19226071 276 11 32.13854        276.05720501 276  3 25.93803
W-Long  : 83.80773929 83 48 27.86146          83.94279499 83 56 34.06197
E-Height: 150.7356                             149.5416
Baseline vector:   -9839.2603   -10690.9170   -10098.3296

Mark1_xyz : 499359.2995 -4602470.6194 4372824.2683
Az1 E1 D1 : 218.17046      -0.0834 17694.1519
E1 N1 U1 : -10912.4583    -13919.7439 -1.1940
Mark2_xyz : 489520.0392 -4613161.5364 4362725.9387
Az2 E2 D2 : 38.07750      -0.0757 17694.1519
E2 N2 U2 : 10935.0401     13919.4351 1.1940

Double-Difference Epochs:
Prn: 11 Start epoch: 132 End epoch: 352
Prn: 18 Start epoch: 2 End epoch: 352
Prn: 19 Start epoch: 2 End epoch: 352
Prn: 27 Start epoch: 280 End epoch: 352
Prn: 28 Start epoch: 5 End epoch: 352
Prn: 29 Start epoch: 2 End epoch: 339

THE FLOAT DOUBLE DIFFERENCE SOLUTION (L1)
Measure of geometry: 0.103203 Wavelength = 0.190294 (m/cycle)
num meas = 1332 num used = 1317 rms resid = 0.004061(m)
Post-Fit Chisq = 42.171 NDF = 12.194

Reference SV: 18
SV Ambiguity FIT Meas SV Ambiguity FIT Meas
11 22406589.878f 0.024 211 19 21161231.999f 0.018 350
27 10785453.076f 0.024 72 28 28836460.832f 0.022 348
29 5129536.945f 0.021 336

Sigmax (m): 0.015558
Sigmay (m): 0.010159
Sigmaz (m): 0.004803
SigmaN (cy): 0.075992
SigmaN (cy): 0.018403
SigmaN (cy): 0.034642
SigmaN (cy): 0.089934
SigmaN (cy): 0.033807
x y z N N N
x 1.00
y 0.72y 1.00
z-0.50z-0.65z 1.00
N 0.97N 0.72N-0.59N 1.00
N-0.10N 0.42N-0.05N-0.05N 1.00

```

Figure H-4c. Ashtech LINECOMP baseline reduction output file (Baseline 1001-4004)

```

N-0.31N 0.26N-0.05N-0.26N 0.67N 1.00
N 0.99N 0.76N-0.52N 0.98N-0.00N-0.24N 1.00
N 0.89N 0.57N-0.60N 0.93N-0.11N-0.32N 0.90N 1.00

del_station: 0.000000 0.000000 0.000000
  Station1: FIXED STATION          Station2: UNKNOWN STATION

          (00000)      (1001)          (00000)      (4005)
Latitude: 43.55907536 43 33 32.67131    43.43379217 43 26 1.65179

E-Long   : 276.19226071 276 11 32.13854    276.05720515 276  3 25.93854

W-Long   : 83.80773929 83 48 27.86146      83.94279485 83 56 34.06146

E-Height: 150.7356                          149.5272

Baseline vector:   -9839.2497   -10690.9086   -10098.3429

Mark1 xyz : 499359.2995 -4602470.6194 4372824.2683
Az1 E11 D1 : 218.17042 -0.0834 17694.1485
E1 N1 U1 : -10912.4468 -13919.7486 -1.2084
Mark2 xyz : 489520.0498 -4613161.5280 4362725.9254
Az2 E12 D2 : 38.07746 -0.0756 17694.1485
E2 N2 U2 : 10935.0287 13919.4398 1.2084

AMBIGUITY RESOLUTION
          1          2          3          4
Abs Contrast 0.008 0.000 0.000 0.000
Contrast      100.000 100.000 100.000 100.000
Change Chi2  38.426 4588.301 4624.842 5296.077
Bias S18:11  22406590 22406591 22406589 22406590
Bias S18:19  21161232 21161232 21161232 21161232
Bias S18:27  10785453 10785453 10785453 10785454
Bias S18:28  28836461 28836462 28836460 28836461
Bias S18:29  5129537 5129537 5129537 5129537
NDF=136.7000 Chi2=42.1709

THE FIXED DOUBLE DIFFERENCE SOLUTION (L1)
Measure of geometry: 0.030142 Wavelength = 0.190294 (m/cycle)
num meas = 1332 num_used = 1315 rms_resid = 0.005514(m)
Post-Fit Chisq = 77.434 NDF = 12.176

Reference SV: 18 Integer Search Ratio = 100.000
SV  Ambiguity FIT Meas SV  Ambiguity FIT Meas
11  22406590.000X 0.031 213 19  21161232.000X 0.029 350
27  10785453.000X 0.053 65  28  28836461.000X 0.025 349
29  5129537.000X 0.024 338

Sigmax (m): 0.002257

```

Figure H-4d. Ashtech LINECOMP baseline reduction output file (Baseline 1001-4004)

```
Sigmay (m):      0.005658
Sigmaz (m):      0.004546
x      y      z
x 1.00
y 0.19y 1.00
z 0.12z-0.72z 1.00

del_station: 0.000016 0.000949 -0.000715
  Station1: FIXED STATION          Station2: UNKNOWN STATION

              (00000)      (1001)              (00000)      (4005)
Latitude: 43.55907536 43 33 32.67131      43.43379220 43 26 1.65191
E-Long   : 276.19226071 276 11 32.13854      276.05720552 276 3 25.93986
W-Long   : 83.80773929 83 48 27.86146      83.94279448 83 56 34.06014
E-Height: 150.7356                          149.5220

Baseline vector:      -9839.2208      -10690.8991      -10098.3438

Mark1_xyz : 499359.2995 -4602470.6194 4372824.2683
Az1 E1 D1 : 218.17035      -0.0835      17694.1272
E1 N1 U1  : -10912.4172      -13919.7449      -1.2136
Mark2_xyz : 489520.0787 -4613161.5185 4362725.9246
Az2 E2 D2 : 38.07739      -0.0756      17694.1272
E2 N2 U2  : 10934.9990      13919.4360      1.2136
Fri Mar 26 10:39:26 1993
```

Figure H-4e. Ashtech LINECOMP baseline reduction output file (Baseline 1001-4004)

```

PROGRAM SHOOTER
Input: FILLNET.IN                               Output: 083084aa.lop

STARTING STATION NAME: 1001

```

LINE FROM	TO		DX	DY	DZ	LENGTH	
1	1001	4008	0833C	-11172.423	-14312.145	-13760.192	22781.646
17	4008	4009	0833B	-412.530	1492.440	1614.982	2237.348
14	4007	4009	0833B	-313.662	-602.201	-613.237	914.926
11	4006	4007	0833A	-864.616	-467.386	-388.225	1056.754
9	4006	4004	0833A	628.445	613.864	569.761	1047.091
24	4005	4004	0843A	60.920	-445.464	-475.513	654.417
20	1001	4005	0843A	-9839.221	-10690.899	-10098.344	17694.127

STATION	LATITUDE	LONGITUDE	ELEV.	GH
1001	43 33 32.67152	83 48 27.85821	150.615	0.000
4008	43 23 18.39708	83 57 49.93702	146.842	0.000
4009	43 24 30.42613	83 58 1.19491	146.545	0.000
4007	43 24 57.46166	83 57 44.51670	156.913	0.000
4006	43 25 14.92267	83 57 4.10971	152.264	0.000
4004	43 25 40.45135	83 56 33.44979	148.694	0.000
4005	43 26 1.65131	83 56 34.05326	149.238	0.000
1001	43 33 32.67072	83 48 27.85454	150.452	0.000

TRAVERSE LENGTH = 46.386 kilometers
MISCLOSURES (LAT., LON., ELEV., meters): -0.025 -0.082 -0.163
LOOP MISCLOSURE = 4.0 ppm

Since geoid heights are not given, the
computed elevations may be seriously in error.

```

STARTING STATION NAME: 1002

```

LINE FROM	TO		DX	DY	DZ	LENGTH	
23	1002	4005	0843A	7853.486	-20463.167	-22275.296	31250.716
10	4006	4005	0833A	567.529	1059.329	1045.274	1592.754
12	4006	4007	0833B	-864.618	-467.386	-388.229	1056.757
16	4008	4007	0833B	-98.867	2094.641	2228.220	3059.781
18	4009	4008	0833C	412.552	-1492.436	-1614.997	2237.360
13	4006	4009	0833B	-1178.280	-1069.587	-1001.466	1880.238
9	4006	4004	0833A	628.445	613.864	569.761	1047.091
24	4005	4004	0843A	60.920	-445.464	-475.513	654.417
8	4005	4007	0833A	-1432.144	-1526.716	-1433.499	2537.088
14	4007	4009	0833B	-313.662	-602.201	-613.237	914.926
5	1002	4009	0833C	6107.640	-22591.898	-24322.208	33753.728

STATION	LATITUDE	LONGITUDE	ELEV.	GH
1002	43 42 37.45123	84 00 46.44187	162.300	0.000
4005	43 26 1.65174	83 56 34.06100	149.529	0.000
4006	43 25 14.92309	83 57 4.11762	152.555	0.000
4007	43 24 57.46199	83 57 44.52470	157.201	0.000
4008	43 23 18.39740	83 57 49.94506	147.130	0.000

Figure H-5. Sample loop closure (Upper Saginaw River Project)

FILLNET.IN										
6378137.0	298.2572221	W	Y	A	50	Y	N	N	N	N
Fillnet Input File	083084	FREE	ADJ	43.5	83.9					
1001	43	33	32.67152	083	48	27.85821	150.615			
1 0										
4008	43	23	18.39709	083	57	49.93704	146.842			
2 0										
4009	43	24	30.42636	083	58	1.19634	146.561			
3 0										
FFF 1002	43	42	37.45123	084	0	46.44187	162.300			
4 0										
4004	43	25	40.44276	083	56	33.45850	148.717			
5 0										
4005	43	26	1.64290	083	56	34.06171	149.245			
6 0										
4007	43	24	57.45316	083	57	44.52581	156.933			
7 0										
4006	43	25	14.91409	083	57	4.11839	152.287			
8 0										
*										
24	3	510	510	0.00	0.00	0.00	0.00	0.00	0.00	0.00
4	1001		4008	0833C	-11172.423	-14312.145	-13760.192	610201020		
1	2									
4	1001		4009	0833C	-11584.984	-12819.715	-12145.194	610201020		
1	3									
4	1002		1001	0833C	17692.643	-9772.176	-12177.017	610201020		
4	1									
4	1002		4008	0833C	6520.196	-24084.335	-25937.204	610201020		
4	2									
4	1002		4009	0833C	6107.640	-22591.898	-24322.208	610201020		
4	3									
4	4004		4005	0833A	-60.916	445.465	475.513			
5	6									
4	4004		4007	0833A	-1493.060	-1081.250	-957.986			
5	7									
4	4005		4007	0833A	-1432.144	-1526.716	-1433.499			
6	7									
4	4006		4004	0833A	628.445	613.864	569.761			
8	5									
4	4006		4005	0833A	567.529	1059.329	1045.274			
8	6									
4	4006		4007	0833A	-864.616	-467.386	-388.225			
8	7									
4	4006		4007	0833B	-864.618	-467.386	-388.229			
8	7									
4	4006		4009	0833B	-1178.280	-1069.587	-1001.466			
8	3									
4	4007		4009	0833B	-313.662	-602.201	-613.237			
7	3									
4	4008		4006	0833B	765.751	2562.026	2616.450			
2	8									
4	4008		4007	0833B	-98.867	2094.641	2228.220			
2	7									
4	4008		4009	0833B	-412.530	1492.440	1614.982			
2	3									
4	4009		4008	0833C	412.552	-1492.436	-1614.997			
3	2									
4	1001		4004	0843A	-9778.301	-11136.364	-10573.856			

Figure H-6. Partial sample of input file for FILLNET Free Adjustment

```

PROGRAM FILLNET, Version 3.0.00
LICENSED TO: ASHTECH INC.

Fillnet Input File 083084 CONSTRAINED      43.5      83.9

a = 6378137.000    1/f = 298.2572221    W      Longitude positive WE
ST

PRELIMINARY COORDINATES:
STR.              LAT.              LON.              ELEV.      G.H.  CON

  1  FF      1001 43 33 32.66675    83 48 27.86095    150.615    0.000
  2      4008 43 23 18.39709    83 57 49.93704    146.842    0.000
  3      4009 43 24 30.42636    83 58  1.19634    146.561    0.000
  4  FFF     1002 43 42 37.45123    84  0 46.44187    162.300    0.000
  5      4004 43 25 40.44276    83 56 33.45850    148.717    0.000
  6      4005 43 26  1.64290    83 56 34.06171    149.245    0.000
  7      4007 43 24 57.45316    83 57 44.52581    156.933    0.000
  8      4006 43 25 14.91409    83 57  4.11839    152.287    0.000

GROUP 1, NO. OF VECTORS AND BIAS CONSTRAINTS:

 24      0.000  0.001    0.000  0.001    0.000  0.000    0.000  0.000

VECTORS:
              DX              DY              DZ              LENGTH  ERROR CODES

1001  4008  -11172.423 -14312.145 -13760.192  22781.646  6102.0 102.
0  4
1001  4009  -11584.984 -12819.715 -12145.194  21120.196  6102.0 102.
0  4
1002  1001   17692.643  -9772.176 -12177.017  23596.711  6102.0 102.
0  4
1002  4008    6520.196 -24084.335 -25937.204  35990.370  6102.0 102.
0  4
1002  4009    6107.640 -22591.898 -24322.208  33753.028  6102.0 102.
0  4
4004  4005    -60.916   445.465   475.513    654.418   3 51.0 51.
0  4
4004  4007  -1493.060 -1081.250  -957.986    2077.515   3 51.0 51.
0  4
4005  4007  -1432.144 -1526.716 -1433.499    2537.088   3 51.0 51.
0  4
4006  4004     628.445    613.864    569.761    1047.091   3 51.0 51.
0  4
4006  4005     567.529   1059.329   1045.274    1592.754   3 51.0 51.
0  4
4006  4007   -864.616  -467.386  -388.225    1056.754   3 51.0 51.
0  4

```

Figure H-7a. Results of Constrained Adjustment (Upper Saginaw River Project)

4006	4007	-864.618	-467.386	-388.229	1056.757	3	51.0	51.
0 4								
4006	4009	-1178.280	-1069.587	-1001.466	1880.238	3	51.0	51.
0 4								
4007	4009	-313.662	-602.201	-613.237	914.926	3	51.0	51.
0 4								
4008	4006	765.751	2562.026	2616.450	3741.145	3	51.0	51.
0 4								
4008	4007	-98.867	2094.641	2228.220	3059.781	3	51.0	51.
0 4								
4008	4009	-412.530	1492.440	1614.982	2237.348	3	51.0	51.
0 4								
4009	4008	412.552	-1492.436	-1614.997	2237.360	3	51.0	51.
0 4								
1001	4004	-9778.301	-11136.364	-10573.856	18205.499	3	51.0	51.
0 4								
1001	4005	-9839.221	-10690.899	-10098.344	17694.127	3	51.0	51.
0 4								
1002	1001	17692.725	-9772.257	-12176.953	23596.773	3	51.0	51.
0 4								
1002	4004	7914.403	-20908.632	-22750.807	31896.832	3	51.0	51.
0 4								
1002	4005	7853.486	-20463.167	-22275.296	31250.716	3	51.0	51.
0 4								
4005	4004	60.920	-445.464	-475.513	654.417	3	51.0	51.
0 4								
SHIFTS:								
1	0.000	0.000	0.102					
2	-0.190	-0.260	0.238					
3	-0.181	-0.230	0.226					
4	0.000	0.000	0.000					
5	0.097	-0.045	0.222					
6	0.095	-0.047	0.238					
7	0.091	-0.049	0.223					
8	0.095	-0.051	0.222					
ADJUSTED VECTORS, GROUP 1:								
			DX,DY,DZ	V	DN,DE,DU	v	v'	
1001	4008	0833C	-11172.608	-0.063	-18960.149	0.017	0.3	
			-14312.293	-0.093	-12630.231	-0.073	-1.1	
			-13760.130	0.105	-10.059	0.135	2.0	
1001	4009	0833C	-11585.141	-0.039	-16736.980	0.014	0.2	
			-12819.845	-0.085	-12881.834	-0.048	-0.8	
			-12145.133	0.095	-6.620	0.124	2.0	
1002	1001	0833C	17692.745	0.058	-16815.857	-0.014	-0.2	
			-9772.339	-0.070	16554.120	0.051	0.7	
			-12177.068	0.052	30.106	0.090	1.3	

Figure H-7b. Results of Constrained Adjustment (Upper Saginaw River Project)

1002	4008	0833C	6520.137	0.019	-35776.006	0.007	0.1
			-24084.632	-0.149	3923.889	0.003	0.0
			-25937.198	0.152	20.048	0.214	2.1
1002	4009	0833C	6107.605	0.038	-33552.837	0.000	0.0
			-22592.184	-0.148	3672.286	0.022	0.2
			-24322.201	0.144	23.486	0.208	2.2
4004	4005	0833A	-60.916	-0.001	654.286	-0.000	-0.0
			445.467	-0.000	-13.234	-0.001	-0.2
			475.516	0.000	1.327	0.000	0.0
4004	4007	0833A	-1493.074	-0.001	-1325.757	-0.001	-0.2
			-1081.252	0.001	-1599.518	-0.001	-0.2
			-957.990	-0.002	5.347	-0.002	-0.3
4005	4007	0833A	-1432.158	0.000	-1980.043	-0.000	-0.0
			-1526.719	0.002	-1586.285	0.000	0.0
			-1433.505	-0.002	4.020	-0.003	-0.4
4006	4004	0833A	628.451	-0.000	787.486	-0.000	-0.1
			613.865	-0.001	690.124	-0.000	-0.1
			569.763	0.000	-2.121	0.001	0.1
4006	4005	0833A	567.535	-0.002	1441.772	-0.000	-0.1
			1059.333	-0.001	676.890	-0.002	-0.3
			1045.278	0.000	-0.794	0.001	0.1
4006	4007	0833A	-864.623	-0.001	-538.271	-0.001	-0.3
			-467.387	0.000	-909.394	-0.001	-0.1
			-388.227	-0.002	3.227	-0.002	-0.2
4006	4007	0833B	-864.623	0.001	-538.271	0.001	0.3
			-467.387	0.000	-909.394	0.001	0.2
			-388.227	0.002	3.227	0.001	0.2
4006	4009	0833B	-1178.293	-0.003	-1372.338	0.002	0.3
			-1069.590	0.001	-1285.281	-0.002	-0.3
			-1001.467	0.001	-8.729	0.000	0.0
4007	4009	0833B	-313.670	-0.004	-834.066	0.000	0.1
			-602.203	0.001	-375.887	-0.004	-0.5
			-613.240	-0.000	-11.955	-0.001	-0.1
4008	4006	0833B	765.761	-0.006	3595.507	0.001	0.2
			2562.037	-0.001	1033.678	-0.006	-0.7
			2616.464	0.002	12.167	0.002	0.2
4008	4007	0833B	-98.862	-0.004	3057.236	0.003	0.4
			2094.651	-0.002	124.284	-0.005	-0.6

Figure H-7c. Results of Constrained Adjustment (Upper Saginaw River Project)

			2228.237	0.005	15.393	0.005	0.6
4008	4009	0833B	-412.532	-0.007	2223.169	0.004	0.7
			1492.448	-0.002	-251.603	-0.007	-1.0
			1614.997	0.006	3.438	0.004	0.6
4009	4008	0833C	412.532	-0.015	-2223.169	0.006	1.2
			-1492.448	-0.002	251.603	-0.015	-1.9
			-1614.997	0.009	-3.438	0.007	0.9
1001	4004	0843A	-9778.397	0.005	-14577.156	-0.004	-0.1
			-11136.390	0.014	-10906.429	0.006	0.2
			-10573.904	-0.017	-0.012	-0.022	-0.8
1001	4005	0843A	-9839.312	0.007	-13922.870	-0.003	-0.1
			-10690.923	0.013	-10919.663	0.009	0.3
			-10098.389	-0.016	1.314	-0.020	-0.8
1002	1001	0843A	17692.745	-0.024	-16815.857	0.001	0.0
			-9772.339	0.011	16554.120	-0.022	-0.7
			-12177.068	-0.012	30.106	-0.019	-0.5
1002	4004	0843A	7914.349	0.002	-31393.013	0.001	0.0
			-20908.729	0.036	5647.691	0.006	0.1
			-22750.972	-0.032	30.094	-0.048	-1.0
1002	4005	0843A	7853.433	0.002	-30738.727	0.003	0.1
			-20463.262	0.036	5634.457	0.005	0.1
			-22275.456	-0.030	31.421	-0.046	-1.0
4005	4004	0843A	60.916	-0.003	-654.286	-0.000	-0.1
			-445.467	-0.001	13.234	-0.003	-0.4
			-475.516	-0.000	-1.327	0.000	0.0
S.E. OF UNIT WEIGHT =			0.843				
NUMBER OF -							
		OBS. EQUATIONS	74				
		UNKNOWNNS	23				
		DEGREES OF FREEDOM	51				
		ITERATIONS	0				
GROUP 1 ROT. ANGLES (sec.) AND SCALE DIFF. (ppm):							
HOR. SYSTEM	0.000	0.000	0.657	5.277			
STD. ERRORS	0.001	0.001	0.166	0.804			
XYZ SYSTEM	0.051	-0.473	0.452				
ADJUSTED POSITIONS:							

Figure H-7d. Results of Constrained Adjustment (Upper Saginaw River Project)

(m)		LAT.	LON.	ELEV.	STD. ERRORS		
1	1001	43 33 32.66675	83 48 27.86095	150.717	0.000	0.000	0.
019							
2	4008	43 23 18.39093	83 57 49.94860	147.080	0.024	0.024	0.
019							
3	4009	43 24 30.42050	83 58 1.20657	146.787	0.022	0.023	0.
019							
4	1002	43 42 37.45123	84 0 46.44187	162.300	0.000	0.000	0.
000							
5	4004	43 25 40.44591	83 56 33.46051	148.939	0.020	0.020	0.
019							
6	4005	43 26 1.64599	83 56 34.06378	149.483	0.020	0.020	0.
019							
7	4007	43 24 57.45612	83 57 44.52799	157.156	0.022	0.022	0.
019							
8	4006	43 25 14.91718	83 57 4.12068	152.509	0.021	0.021	0.
019							
ACCURACIES (m):							
			D. LAT.	D. LON.	VERT.		
1001	4008		0.024	0.024	0.014		
1001	4009		0.022	0.023	0.014		
1002	1001		0.000	0.000	0.019		
1002	4008		0.024	0.024	0.019		
1002	4009		0.022	0.023	0.019		
4004	4005		0.002	0.004	0.004		
4004	4007		0.003	0.004	0.004		
4005	4007		0.003	0.004	0.004		
4006	4004		0.003	0.004	0.004		
4006	4005		0.003	0.004	0.004		
4006	4007		0.002	0.003	0.003		
4006	4007		0.002	0.003	0.003		
4006	4009		0.003	0.004	0.004		
4007	4009		0.003	0.004	0.004		
4008	4006		0.004	0.005	0.004		
4008	4007		0.004	0.005	0.004		
4008	4009		0.003	0.004	0.004		
4009	4008		0.003	0.004	0.004		
1001	4004		0.020	0.020	0.014		
1001	4005		0.020	0.020	0.014		
1002	1001		0.000	0.000	0.019		
1002	4004		0.020	0.020	0.019		
1002	4005		0.020	0.020	0.019		
4005	4004		0.002	0.004	0.004		

Figure H-7e. Results of Constrained Adjustment (Upper Saginaw River Project)

ESTIMATES OF PRECISION						
Based on the VECTOR ACCURACIES produced by FILLNET						
This is a reasonable estimate of the accuracies of the vectors in the network at 1 SIGMA.						
VECTOR	LENGTH	PPM(h)	RATIO(h)	PPM(v)	RATIO(v)	
1001	4008	22781.793	1.5 1:	671215	0.6 1:	1627271
1001	4009	21120.326	1.5 1:	663584	0.7 1:	1508595
1002	1001	23596.882	0.0 1:	0	0.8 1:	1241941
1002	4008	35990.553	0.9 1:	1060382	0.5 1:	1894240
1002	4009	33753.209	0.9 1:	1060499	0.6 1:	1776485
4004	4005	654.421	6.8 1:	146333	6.1 1:	163605
4004	4007	2077.527	2.4 1:	415504	1.9 1:	519382
4005	4007	2537.102	2.0 1:	507420	1.6 1:	634275
4006	4004	1047.096	4.8 1:	209419	3.8 1:	261774
4006	4005	1592.761	3.1 1:	318552	2.5 1:	398190
4006	4007	1056.761	3.4 1:	293091	2.8 1:	352254
4006	4007	1056.761	3.4 1:	293091	2.8 1:	352254
4006	4009	1880.249	2.7 1:	376046	2.1 1:	470062
4007	4009	914.932	5.5 1:	182971	4.4 1:	228733
4008	4006	3741.164	1.7 1:	584269	1.1 1:	935291
4008	4007	3059.800	2.1 1:	477854	1.3 1:	764950
4008	4009	2237.364	2.2 1:	447472	1.8 1:	559341
4009	4008	2237.364	2.2 1:	447472	1.8 1:	559341
1001	4004	18205.594	1.6 1:	643665	0.8 1:	1300400
1001	4005	17694.218	1.6 1:	625585	0.8 1:	1263873
1002	1001	23596.882	0.0 1:	0	0.8 1:	1241941
1002	4004	31897.000	0.9 1:	1127729	0.6 1:	1678789
1002	4005	31250.879	0.9 1:	1104885	0.6 1:	1644783
4005	4004	654.421	6.8 1:	146333	6.1 1:	163605

Figure H-7f. Results of Constrained Adjustment (Upper Saginaw River Project)

```
                                083084C.SPC
;Software: CORPSCON v3.01, Agency: CORPS OF ENGINEERS SAGINAW
;Project: UPPER SAGINAW MAPPING,
;Original Coordinates on NAD 83 Geographic Coordinates
;Translated Coordinates on NAD 83 State Plane Zone 2113,U.S. FOOT

1001 JONAS           ,13271491.47735,  750899.10875
4008 WICKS           ,13230401.67183,  688469.29439
4009 RUST            ,13229535.79827,  695757.90291
1002 PARRISH         ,13216876.80162,  805765.50958
4004 HOYT            ,13235976.88650,  702879.28348
4005 GENESSEE        ,13235921.56530,  705025.46304
4007 EWALD           ,13230753.74995,  698500.99009
4006 HOLLAND         ,13233727.24329,  700283.34945
█
```

Figure H-8. CORPSCON file of translated coordinates to NAD 83

U.S. ARMY ENGINEER DISTRICT - DETROIT																		
<p>GENERAL INFORMATION</p> <p>designation: RUST reference no. SAG-0612</p> <p>project: SAGINAW RIVER channel/reach: UPPER sheet no.</p> <p>USGS Quad: SAGINAW NOAA chart: 14867</p> <p>community: SAGINAW county: SAGINAW state: MICHIGAN Township/Range T.12N R.04E section: 26</p>	<p>HORIZONTAL</p> <p>datum: NAD83 lat: 43° 24' 30.42050" N lon: 83° 58' 1.20657" W</p> <p>Y: 0.00 m (N) X: 0.00 m (E)</p> <p>Y: 695,757.90 ft (US) N X: 13,229,535.80 ft (US) E</p> <p>state: MICHIGAN projection: LAMBERT zone: S code: 2113</p>	<p>HORIZONTAL ORIGIN</p> <p>agency: USACE order: 03/23/93 date: 03/23/93 method: GPS set by: D. HENRY</p> <p>Point source: JONAS 1932 PARRISH</p> <p>MOST RECENT RECOVERY 03/23/93 NEW</p>	<p>VERTICAL</p> <table style="width: 100%; border-collapse: collapse;"> <tr> <td style="text-align: right;">feet</td> <td style="text-align: center;">-----</td> <td style="text-align: left;">meters</td> </tr> <tr> <td>IGLD 1955:</td> <td style="text-align: center;">0.000</td> <td>0.000</td> </tr> <tr> <td>IGLD 1985:</td> <td style="text-align: center;">0.000</td> <td>0.000</td> </tr> <tr> <td>NAVD 1988:</td> <td style="text-align: center;">0.000</td> <td>0.000</td> </tr> <tr> <td>NGVD 1929:</td> <td style="text-align: center;">0.000</td> <td>0.000</td> </tr> </table> <p>pt. source: geoid. hgt: 0.000 0.000</p> <p>PROPERTY OWNER firm: SAGINAW P.O.C. BOAT LAUNCH telephone: access: car, boat</p>	feet	-----	meters	IGLD 1955:	0.000	0.000	IGLD 1985:	0.000	0.000	NAVD 1988:	0.000	0.000	NGVD 1929:	0.000	0.000
feet	-----	meters																
IGLD 1955:	0.000	0.000																
IGLD 1985:	0.000	0.000																
NAVD 1988:	0.000	0.000																
NGVD 1929:	0.000	0.000																
<p>DESCRIPTION</p> <p>STATION IS A BRASS DISK SET IN CONCRETE ON THE NORTH SIDE OF A BOAT LAUNCH RAMP (RUST AVE. BOAT LAUNCH) OWNED BY THE CITY OF SAGINAW. TO REACH STATION FROM THE RUST STREET BRIDGE (M-46) OVER THE SAGINAW RIVER, TAKE SOUTH HAMILTON SOUTH TO LEE STREET, GO EAST TO RIVER AND RUST AVE. BOAT LAUNCH IS AT THE END OF THE STREET. NOTE: THERE ARE TWO SIGNS DIRECTING YOU TO THE BOAT LAUNCH, LEE ST. & SOUTH HAMILTON, AND ONE NEAR THE BRIDGE ON THE WEST SIDE OF THE RIVER.</p>																		
<p>SKETCH</p>																		
<p>Ref # SAG-0612</p>		<p>SURVEY CONTROL DATA Design: 1 RUST</p>																
<p>Office of Record: Saginaw Area Office Printed on 11/04/93</p>																		

Figure H-9. Final station description of point RUST (typical)

Appendix I

Application: Rio Guamani, Puerto Rico Section 205 Flood Control Project--GPS Horizontal and Vertical Control Densification (Jacksonville District)

This appendix is an example of a constrained adjustment of a static GPS survey performed to set basic horizontal and vertical control for a flood control project near Guayama on the south coast of Puerto Rico. The survey was performed in March 2002 by Renan L. Lopez de Azua & Associates (RLDA) under contract for the Jacksonville District. The Trimble GPSurvey screen capture below is a sketch of the 14 points that were occupied on this survey. GPS observations between points are shown by solid lines. Nine of the 14 points were held fixed in the constrained adjustment. Five new 3D control points were located. No conventional observations were included in this sample adjustment although some conventional leveling was performed. These leveling observations were later included in a subsequent readjustment.

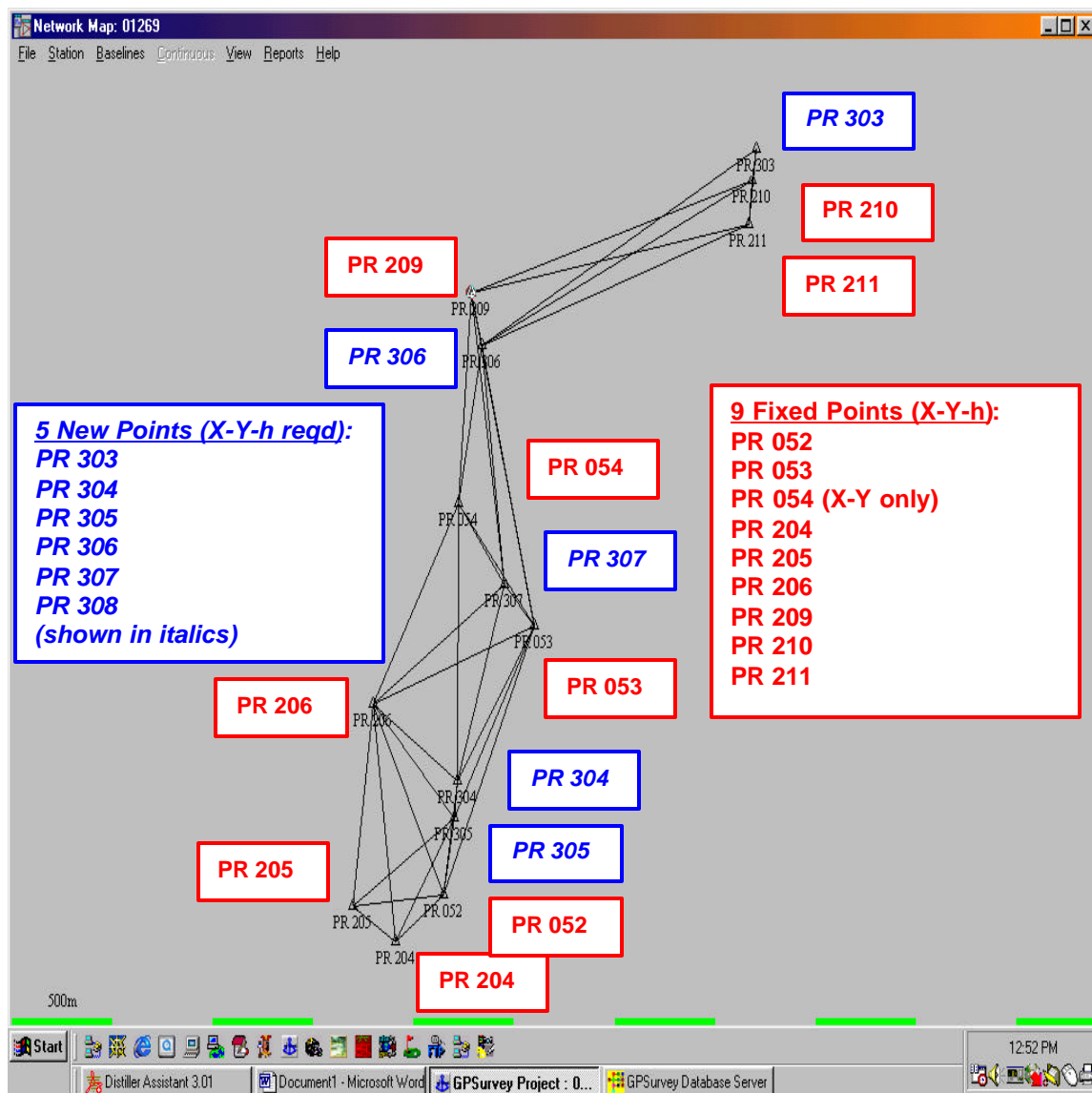

Figure I-1. Diagram of constrained network adjustment

a. A total of 46 baselines were observed on the network shown in Figure I-1 above. Since vertical densification was being performed, duplicate baseline observations were performed. One baseline was subsequently excluded from the final constrained adjustment, resulting in 45 vectors. This produced 135 3D observation equations in the final adjustment. With the 14 geoid heights, a total of 149 observations were adjusted.

b. Initially, a free adjustment was performed over the network and outliers are removed. Next, the geoid model is inserted and adjusted and revised geoid model files are inserted back into GPSurvey before the final constrained adjustment is run. These preliminary adjustments are not shown in this example--only the final constrained adjustment is illustrated on the following pages.

c. The vertical orthometric datum used for this project in Puerto Rico is "Mean Sea Level," which is often termed NGVD 29 even though there is no direct relationship with the CONUS NGVD 29 datum.

d. The following pages contain excerpts from the Technical Instructions issued by the Jacksonville District for this project.

REQUEST FOR PROPOSAL

Engineering Division
Design Branch

SUBJECT: Contract No. DACW17-02-D-0002

Mr. Renan Lopez De Azua
R. Lopez De Azua & Associates, Inc.
1959 Loiza Street
San Juan, Puerto Rico 00911-1422

Dear Mr. De Azua:

Reference contract number DACW17-02-D-0002 for Surveying and Mapping Services. The Government desires to execute a delivery order under subject contract for the following project:

RIO GUAMANI AT GUAYAMA, SECTION 205,
FLOOD CONTROL PROJECT, ADDITIONAL SURVEYS,
PLANS AND SPECIFICATIONS SURVEY, GUAYAMA, PUERTO RICO (Survey No. 01-269)

Please review the enclosed scope of work outlining the technical requirements and submit an itemized fee proposal for this work within 10 working days of receipt of this document. Please furnish this fee proposal to the attention of the Chief, Design Branch.

This request does not constitute a notice to proceed for the delivery order. Please do not commence work or incur any costs chargeable to the Government. You are cautioned that preparation of this fee proposal is entirely at your own risk and the Government can assume no obligation for payment of any related expenses incurred by your firm.

Mr. Robert Jenkins of the Survey Section is the point of contact. Please call him at 904-232-1610 if you have questions or need additional information.

Sincerely,

Walter Clay Sanders, P.E.
Assistant Chief, Engineering Division

Enclosures

TECHNICAL REQUIREMENTS
RIO GUAMANI AT GUAYAMA, SECTION 205 FLOOD CONTROL PROJECT, ADDITIONAL
SURVEYS PLANS AND SPECIFICATION SCOPE SURVEY,
GUAYAMA, PUERTO RICO (Survey 01-269)

1. LOCATION OF WORK. The project is located in the vicinity of Rio Guamani at Guayama, Puerto Rico.

2. SCOPE OF WORK.

2.a. The services to be rendered by the Contractor include obtaining hydrographic and topographic data of project features to be surveyed as shown on Enclosure 2 (plan plot). The project area was originally surveyed by Survey No. 98-062. The required surveys are to provide additional information not shown on the original survey. The additional data shall be merged with the original data and provide it as a single survey. All survey work shall be done in the Metric System.

2.b. The services to be rendered by the Contractor include all the work described in these technical requirements. Details not specifically described in these instructions are nevertheless a firm requirement if they can be identified as an item, or items, commonly a part of professional grade work of a comparative nature.

2.c. The Contractor shall furnish all necessary materials, labor, supervision, equipment, and transportation necessary to execute and complete all work required by these specifications.

2.d. The Corps of Engineers, Survey Section shall be contacted the same day that the Contractor plans to commence the work.

2.e. Rights-of-Entry must be obtained verbally and recorded in the field book before entering on the private property. Enter in the field book the name and address of the property owner contacted for rights-of-entry.

2.f. COMPLIANCE. : Surveying and Mapping shall be in strict compliance with EM-1110-1-1000 for Photogrammetric Mapping, EM-1110-1-1002 Survey Markers and Monumentation, EM-1110-1-1003 NAVSTAR Global Positioning System Surveying, EM-1110-1-1004 Deformation Monitoring and Control Surveying, EM-1110-1-1005 Topographic Surveying, EM-1110-2-1003 Hydrographic Surveying, EM-1110-1-2909 Geospatial Data and System, Tri-Services A/E/C CADD Standards, Tri-Services Spatial Data Standards, Related Spatial Data Products and Chapter 177, Chapter 472, and Chapter 61G17 of the Minimum Technical Standards set by the Puerto Rico Board of Professional Surveyors and Mappers

2.f(1). STANDARDS FOR DIGITAL GEOSPATIAL METADATA. Metadata are "data about data". They describe the content, identification, data quality, spatial data organization, spatial reference, entity and attribute information, distribution, metadata reference, and other characteristics of data. Each survey project shall have metadata submitted with the final data submittal. Furnish a digital file using CORPSMET 95 (Metadata Software) with the appropriate data included. Enclosure 5 is an example of the metadata file printed. Point of contact in Survey Section is William Mihalik at 904-232-1462.

2.g. All digital data shall be submitted on CD ROM's.

3. FIELD SURVEY EFFORT. The area of work is outlined in Enclosure 1 (technical requirements) and depicted in yellow on Enclosure 2 (prints), Enclosure 3 (digital design file), Enclosure 4 (control monuments and descriptions).

Technical Requirements: Rio Guamani at Guayama, Section 205 Flood Control Project (Continued)

3.a. CONTROL. The Horizontal datum shall be based on the Lambert Projection for Puerto Rico and the US Virgin Islands, North Zone (NAD 1983 meters). The vertical datum shall be NGVD of 1929. All control surveys shall be Third Order, Class II accuracy. Establish (replace missing or disturbed control monuments and/or set) by any of the following methods.

3.a(1) The basic control network shall be accomplished using precise differential carrier-phase Global Positioning System (GPS). Differential GPS baseline vector observations shall be made in strict accordance with the criteria contained in the engineering manual EM-1110-2-2003 and with the Geometric Geodetic Accuracy Standards And Specifications For Using GPS Relative Positioning Techniques by Federal Geodetic Control Committee, version 5.0.

3.a(2) Network design, station and baseline occupation requirements, for static and kinematic surveys, satellite observation time per baseline, baseline redundancies, and connection requirements to existing networks, shall follow the criteria given in the above said engineering manual. A field observation log shall be completed at each setup in the field.

3.a(3) GPS derived elevation data shall be supplied in reference to the above said datum. Existing benchmark data and stations shall be used in tandem in a minimally constrained adjustment program to model the geoid. All supporting data used in vertical adjustment shall be submitted. The GPS plan shall be submitted and approved by Mr. David J. Robar prior to commencing work.

3.a(4) Existing Corps of Engineers control data shall be utilized for horizontal and vertical control at the project site. The GPS network shall commence from the control shown on Enclosure 3. All established or recovered control shall be fully described and entered in a FIELD BOOK, in accordance with the Technical Requirements of this contract. All control surveys shall be Third Order, Class II accuracy. The Contractor shall submit the field data and abstracts for the control networks to Survey Section for computation before commencing the mapping. The monument designations shall be furnished as requested.

3.a(5) All horizontal and vertical control (double run forward and back) established shall be a closed traverse or level loop no spur lines, with third order accuracy. All horizontal and vertical control along with baseline layouts, sketches, and pertinent data shall be entered in field books.

3.a(6) All monuments, survey markers, etc., recovered shall be noted on the copies of control descriptions. Control points established or recovered with no description or out-of-date (5 Years old) description shall be described with sketches for future recovery use.

3.a(7) All original field notes shall be kept in standard pocketsize field books and shall become the property of the Government. The first four pages of the field books shall be reserved for indexing and the binding outside edge shall be free of all marking.

3.b. FIELD SURVEY EFFORT: A Contract Plans and Specification Scope Hydrographic, Topographic and Utility Surveys are requested of the project area.

3.b(1) Topographic Survey: Take conventional spot elevations and cross sections (field data) at intervals sufficient to calculate earthwork quantities for plans and specifications in accordance with FAR 52.236-16 QUANTITY SURVEYS. Collect additional data points necessary to define the existing terrain at alignment and grade changes, and where roads, and other feature alignments cross through or run adjacent to the survey area. The surface model shall be of adequate density and quality to produce a one-foot contour interval derived from the original digital terrain model (DTM) file. Locate and detail culverts, utilities, fences, and other structures. Locate tree lines and other planimetric features. Locate all property irons and monuments in the survey area. Plot all field data points (x,y,z) unless thinning is required for readability of text.

Technical Requirements: Rio Guamani at Guayama, Section 205 Flood Control Project (Continued)

3.b(1)a Locate all power poles, power lines, extend limits of fencing and extend topography as noted on the enclosure.

3.b(1)b PR 53 Bridge: From north side of bridge to the intersection with PR3. Include gabions at intersection of PR 3 and PR 53.

3.b(1)c Pozo Hondo Bridge: Bridge has been replaced since previous survey and therefore must be resurveyed.

3.b(1)d At the west end of the project, determine limits of pavement, sanitary manhole and distribution, extend topo to fence along back of housing project.

3.b(1)e Fill area near northeast corner of PR 3 and PR 53.

3.b(1)f For siphon structure crossing the river, determine location and top elevation. For the structure along the edge of the street, determine location, top elevation, inverts and pipe sizes.

3.b(1)g Concrete irrigation channel, determine location, size and inverts at 50m intervals. For structure, determine location, invert and pipe size.

3.b(1)h For channel, located on southwest side of project approximately 500 meters west of PR 53, locate and provide topography from end of concrete to where it intersects with Rio Guamani.

3.b(2) PLANIMETRICS: All standard, geographic, and surface-visible features which are visible or identifiable shall be located with (X, Y, & Z) angles and distances including land use features, structural features, hydrographic features, and scale-dependent features.

3.b(3) LAND USE FEATURES: Land use features include parks, golf courses, and other recreational areas, historic areas, archeological sites, buildings, fences and walls, canals, ditches, reservoirs, trails, streets, roads, railroads, quarries, borrow pits, cemeteries, orchards, boundaries of logged-off areas and wooded areas, individual lone large trees, the trace of cross-country telephone, telegraph, and electric power transmission lines and their poles and towers, fence lines, billboards, rocks, and other walls, and similar details.

3.b(4) STRUCTURAL FEATURES: Structural features include bridges, trestles, tunnels, piers, retaining walls, dams, power plants, transformer and other substations, transportation terminals, and airfields, oil, water, and other storage tanks, and similar detail.

3.b(5) HYDROGRAPHIC FEATURES: Hydrographic features included rivers, stream, lakes, ponds, marshes, springs, falls and rapids, glaciers, water wells, and similar details.

3.b(6) CULVERT/WEIRS: Provide survey of the weirs and culverts and all appurtenances to include invert elevation of outflow pipe, diameter of pipe, waterside length of pipe to discharge, and invert elevation of pipe at discharge. Locate with X, Y, and Z all culverts and weirs. Obtain invert elevations, top elevations at both ends, length of culverts, size, and direction for the existing culverts.

3.b(7) BRIDGE SURVEYS: Elevation shall be taken every 5 meter and at any grade change in both directions. The limit shall extend 20 meter upstream and downstream of each bridge, and the width of the adjacent channel survey. Survey shall be in accordance with US ARMY CORPS OF ENGINEERS TECHNICAL REQUIREMENT FOR SURVEYING, MAPPING AND PHOTOGRAMMETRIC SERVICES Section 12.7 "Bridge Surveys".

Technical Requirements: Rio Guamani at Guayama, Section 205 Flood Control Project (Continued)

3.b(7)a An efforts shall be made by the survey contractor to obtain as-built data and prints of these structures which can be field verified and incorporated into the final submission. Should the survey contractor experience any difficulty in coordinating and obtaining information, the survey contractor should seek assistance from CESAJ-EN-DT Mr. Rob Jenkins at 904-232-1610 and the local sponsor's designated representative.

3.b(8) Property Corners: Locate all property irons and monuments that are found (NO PROPERTY SURVEY).

3.b(9) UTILITIES: The scope of this survey should include locating and providing data on all the existing aerial/underground utilities within the two areas. Locate all the existing aerial/surface utilities. Data required includes but is not limited to the field location of sanitary and storm sewer mains, trunks, laterals, catch basin and manholes, potable water mains, meters and valves, fire protection mains, electrical lines and poles and lowest point along the lines, transformers, junction boxes, and manholes, telephone lines, junction boxes, and manholes, cable television lines and junction boxes and Gas/Natural Mains. All utility information secured for this survey must be shown on the drawings.

3.b(9)a. SANITARY AND STORM SEWERS: The survey should include a manhole diameter, manhole construction material, size of lines, type of pipe, line size invert elevations, drop elevations in the manholes and top elevation of manholes. Obtain invert elevation and top elevations for all catch basins.

3.b(9)b. POTABLE WATER: The survey should indicate the location and elevations of the valves, meters mains.

3.b(9)c. FIRE PROTECTION MAINS: Locate all fire protection mains, fire hydrants, size of mains, type of pipe, and the type and location of valves in the survey area.

3.b(9)d. ELECTRICAL POWER LINES AND TELEPHONE LINES AND BOXES: Locate all aerial and underground lines and manholes within the survey area. Indicate the height and location (in X-Y coordinates) of poles for all aerial lines. The survey shall include the channel crossing and a minimum of two supporting structures (poles, towers,) beyond. In the event the crossing creates a junction within the two supporting structures the survey shall include two supporting structures in the direction of each leg created. Indicate the low wire elevation of all lines crossing the channel and at the power pole. The survey Contractor shall indicate electrical lines supported on bridges, and sizes of conduit, etc.

3.b(9)e. CABLE TELEVISION: Locate and name all aerial and underground cable television lines and manholes. Indicate the height and location (in X-Y-Z coordinates) of poles or manholes lines. Indicate the low wire elevation of all lines crossing the channel.

3.b(9)f. HIGHWAY RIGHT-OF-WAY/EASEMENTS. All highway or road right-of-way or easements shall be researched for recorded as-built data. Obtain additional Real Estate data as necessary including deeds, maps, title and parcel data in the vicinity to determine the correct positions of the subject right-of-way or easements. Perform a field survey traversing and connecting all available corners for each parcel or tract of land. The recorded data shall be included in the digital files.

3.b(9)g. UTILITY RIGHT-OF-WAY OR EASEMENTS. All electrical, telephone, sewer, water, cable, and electrical easements shall be researched for recorded as-built data. Obtain additional Real Estate data as necessary including deeds, maps, title and parcel data in the vicinity to determine the correct positions of the subject parcels. Perform a field survey traversing and connecting all available corners for each parcel or tract of land as needed. The record data shall be included in the digital files.

Technical Requirements: Rio Guamani at Guayama, Section 205 Flood Control Project (Continued)

3.c BREAKLINE. Breaklines shall be located for all natural or man-made features as needed (on sections). The breaklines shall be located with X, Y, and Z and identified.

3.d DATA COLLECTION (KINEMATIC/RTK OR TOTAL STATION). Data collection will be allowed for data points only, showing all instrument positions, calibration, backsites and closing readings in the field book. Mr. Robar shall be contacted if you plan to use GPS (RTK) before utilizing. If RTK is utilized Q1 and Q2 files shall be furnished. Before using RTK, one session shall be performed around the expected survey area. After observation of the primary control (four monuments; one on each corner of the work area) the geoid model shall be prepared utilizing the four occupied monuments data. The geoid model shall be furnished to the Corps of Engineers for review and acceptance. CAUTION, unless the one session is observed with the four monuments before modeling the geoid, all data will be rejected and returned to the Contractor.

4. DATA PROCESSING. The Contractor shall make the necessary computations to verify the correctness of all measurements and apply the proper theory of location in accordance with the law or precedent and publish the results of the survey. The Contractor shall submit advance copies of the horizontal control so that USACE can compute the final positions before setting property corners that shall be established. Compute and tabulate the horizontal and vertical positions on all work performed. Review and edit all field data for discrepancies before plotting the final drawings.

4.a. Furnish X, Y, Z and descriptor ASCII file for each cross section and locate feature and one X, Y, Z, and descriptor ASCII file with all sections and features included.

5. CADD. The survey data shall be translated or digital capture into Intergraph IGDS 3D design files according to the specifications furnished. The survey data (cover, control, site plan, plan sheets, and section drawings) shall be provided in Intergraph MicroStation (PC or 32) Version 4.0 or higher, AT&T System V UNIX, CLIX R3.1 Vr. 6.3.2 format as shown in the letter dated 30 September 1992. The neat mapping area on all sheets (covers and plans) shall be 30-inches by 25-inches.

5.a. GLOBAL ORIGIN. The IGDS 3-D design file shall be prepared with a global origin of 0,0, 2147483.658, Design file master units: MM., Sub units: 1,000, and positional units: 1. The file name shall be the survey number prefixed to a "C," i.e., C269S1.DGN. All reference file's name shall commence with the C269 also.

5.b. DIGITAL TERRAIN MODEL (DTM) DATA. The Contractor shall develop and deliver a surface model of the survey area using Intergraph compatible Digital Terrain Modeling software and the model file shall have the .dtm extension. The digital terrain model shall be developed from cross sections, spot elevations, and breaklines. Breaklines should include ridges, drainage, road edges, surface water boundaries, and other linear features implying a change in slope. The surface model shall be of adequate density and quality to produce at 1-Foot minor contour interval and major contours on an interval of 5-Foot derived from the original DTM (Digital Terrain Model) file. The contour data shall be incorporated as a reference file into the final data set. All data used to develop the DTM's shall be delivered in Intergraph 3-D design files.

5.b(1) CONTOURS. The contours shall be developed in the digital terrain model (DTM). The contours shall be provided in one or more master DGN files and attached as a reference file to all sheet files utilizing the clip bounds methods. Each contour shall be drawn sharp and clear as a continuous solid line, dashed contours are not acceptable. Every index contour shall be accentuated as a heavier line than the intermediate and shall be annotated according to its actual elevation above NGVD 29. Whenever index contours are closer than one-quarter (1/4) inch, and the ground slope is uniform, the intermediate shall be omitted (in this case only plot the 5-Foot contours). Labeling or numbering of contours shall be placed on top of the contour line, so that the elevation is readily discernible, do not break contours. Labeling of intermediate contours may be required in areas of low relief.

Technical Requirements: Rio Guamani at Guayama, Section 205 Flood Control Project (Continued)

5.c. MASTER DGN FILES. (Scale 1:1)

5.c(1) The survey data (DTM data points) points shall be provided in one or more master DGN file and attached as a reference file to all sheet files utilizing the clip bounds methods.

5.c(2) The planimetric data shall be provided in one or more master DGN file and attached as a reference file to all sheet files utilizing the clip bounds methods.

5.c(3) The culvert/weirs data shall be provided in one or more master DGN file and attached as a reference file to all sheet files utilizing the clip bounds methods.

5.c(4) The bridge data shall be provided in one or more master DGN file and attached as a reference file to all sheet files utilizing the clip bounds methods.

5.c(5) The road data shall be provided in one or more master DGN file and attached as a reference file to all sheet files utilizing the clip bounds methods.

5.c(6) The utility data points shall be provided in one or more master DGN file and attached as a reference file to all sheet files utilizing the clip bounds methods.

5.c(7) The contours shall be provided in one or more master DGN file and attached as a reference file to all sheet files utilizing the clip bounds methods.

5.c(8) The breaklines shall be provided in one or more master DGN file and attached as a reference file to all sheet files utilizing the clip bounds methods **DO NOT PLOT THE BREAKLINES.**

5.d. COVER AND CONTROL SHEET. The first sheet shall be a cover sheet showing the control sketch, survey control tabulation, sheet layout or index, legend, project location map, survey notes, north arrow, graphic scale, grid ticks, and large signature block. Tabulate, plot, and list the horizontal control used for the survey on the final drawings.

5.e. PLAN SHEETS: The plan sheets shall be prepared to a scale of 1:1000 and 1:200 (METRIC), in the Corps of Engineers format (reference letter and instruction dated September 30, 1992) showing notes, title block, grid, north arrow, graphic scale, legend, sheet index, and D. O. File Number. Sheets shall be oriented with north to the top. The extreme right 177.8MM/7 inches of the sheet shall be left blank for notes, legends, etc. The second sheet and all sheets following shall be a continuation sheet and shall have a minimum of two notes, note 1: See Drawing number 1 for notes, note 2: Refer to Survey No. 01-269. Plans sheets title block shall be labeled as shown in Enclosure 4.

5,e(1) Section Views. The sections shall be extracted and displayed from the digital terrain model (DTM OR TNT) utilizing INROADS OR INXPRESS. The sections shall be generated or extracted along the same azimuth as the section was collected in the field. The sections shall be displayed at a 10 to 1 vertical exaggeration. The planimetric lines (alignment of extraction), alignment, stations, and cross sections shall be displayed in one DGN file, "**DO NOT PLOT**".

6. MAP CONTENT.

6a. Coordinate Grid: Grid ticks (English) of the applicable State Plane Coordinate System shall be properly annotated at the top, bottom and both sides of each sheet. Spacing of the grid ticks shall be 127MM/5 inches apart.

6.b. CONTROL. All horizontal and vertical ground control monuments shall be shown on the maps in plan and tabulated. In addition, show the channel limits (station, range and R/W) on the completed drawings.

6.c. PLANIMETRIC. The maps shall contain all surface-visible utilities and planimetric which are visible or identifiable.

6.d. TOPOGRAPHY. The map shall contain all representable and specified topographic features which are visible or identifiable.

Technical Requirements: Rio Guamani at Guayama, Section 205 Flood Control Project (Continued)

6.e. SPOT ELEVATIONS. Spot elevations shall be shown on the maps in proper position. In areas where the contours are more than 3 inches apart at map scale, spot elevations shall be shown. The horizontal distance between the contours and such spot elevations or between the spot elevations shall not exceed two (2) inches at scale of delivered maps.

6.f. CONTOURS. The contours shall be developed in the digital terrain model (DTM). Each contour shall be drawn sharp and clear as a continuous solid line, dashed contours are not acceptable. Every index contour shall be accentuated as a heavier line than the intermediate and shall be annotated according to its actual elevation. Whenever index contours are closer than one-quarter (1/4) inch, and the ground slope is uniform, the intermediate shall be omitted. Labeling or numbering of contours shall be placed on top of the contour line, so that the elevation is readily discernible, do not break contours. Labeling of intermediate contours may be required in areas of low relief.

6.g. MAP EDIT. All names, labels, notes, and map information shall be checked for accuracy and completeness. All commercial buildings, roads and man made features shall be labeled with the type of construction, purpose and name. All residences shall be labeled with the type of construction.

6.h. SHEET INDEX AND LEGEND. On plan drawings a small scale sheet index shall be shown on each sheet of the series; highlighting the sheets in the standard manner. Planimetric and topographic feature legends shall be shown on each sheet. Contractor logo shall be shown on each drawing.

6.i. MAP ACCURACY. All mapping shall conform to the national map accuracy standards except that no dashed contour line will be accepted.

7. SURVEY/QUALITY CONTROL REPORT. The Contractor shall furnish a digital (*.doc) file on the final CD. The report shall include Right-of-Entry information, Control monuments Designation recovered, destroyed, fixed, included in control network, tide gauge location and monument used, dates of field survey collection, types of equipment used, quality control checks, and digital files. Unique circumstances and/or issues related to this survey, general approach/methodology to this survey. Along with any other data required in accordance with the law or precedent and for the Corps of Engineers to publish the results of the survey.

8. DELIVERIES. On completion, all data required shall be delivered or mailed to Design Branch, Survey Section at the address shown in contract, and shall be accompanied by a properly numbered, dated and signed letter or shipping form, in duplicate, listing the materials being transmitted. All costs of deliveries shall be borne by the Contractor. Items to be delivered include, but are not limited to the following:

- 8.a. GPS network plan, (before GPS work commences).
- 8.b. GPS raw data log sheets filled out in field with all information and sketches.
- 8.c. Plan sheet layout.
- 8.d. Computation files with Horizontal and Vertical abstracts along with any Q1 and Q2 files.
- 8.e. Horizontal and Vertical Field Books.
- 8.f. Furnish X, Y, Z, and descriptor ASCII file for each cross section and one merged with all data collected for all cross section.
- 8.g. DTM File.
- 8.h. DGN files to a scale of 1:1000 and 1:200.
- 8.i. Furnish a digital file using CORPSMET 95 (Metadata Software) with the appropriate data included.
- 8.j. Advance paper plots of all plan sheets, cover sheet and control sheets for approval.
- 8.k. Final paper plots on standard sized (30-inches by 42-inches, 2 set paper plots).
- 8.l. Survey Report C269*.doc file.

I-1. Loading RINEX Files for Baseline Processing

This screen capture in Figure I-2 below shows how the RINEX baseline observation files (e.g., *.02o) are loaded from the source file directory into the program GPSurvey. At this stage baselines can be selectively included or excluded from the adjustment.

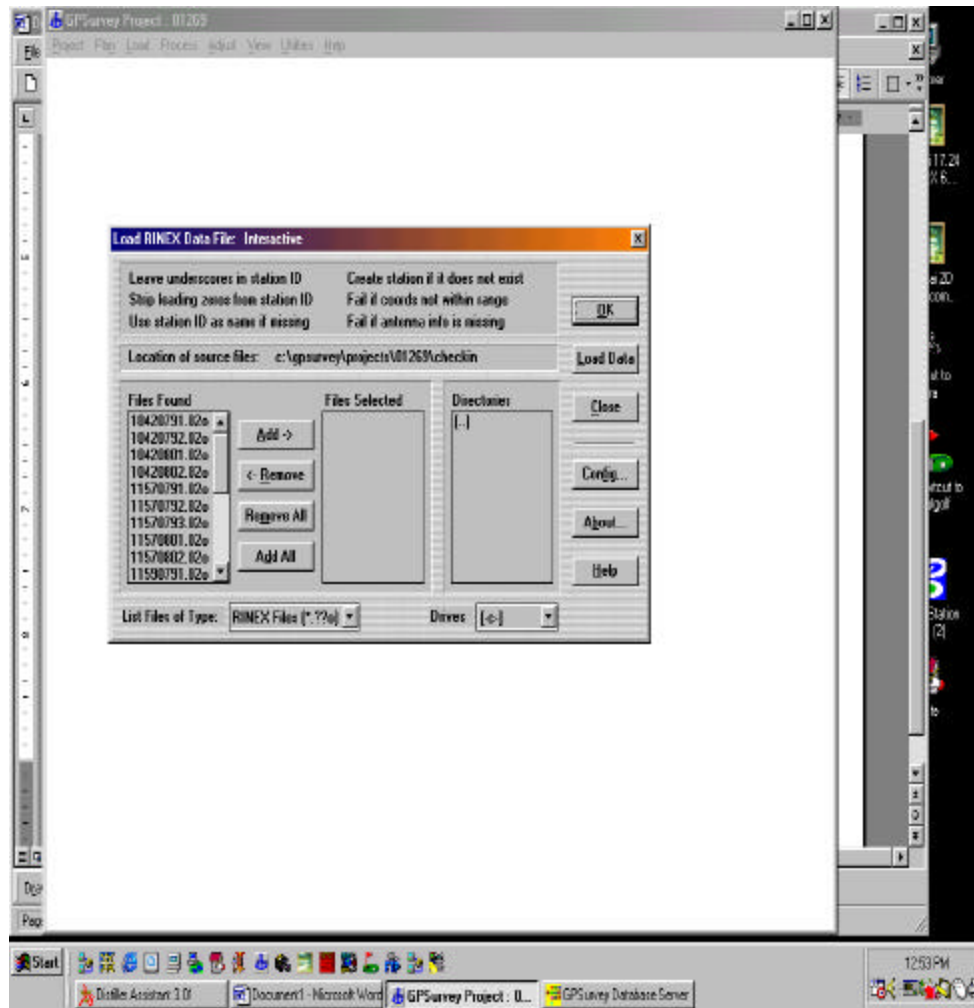

Figure I-2. Loading RINEX data files

The screen capture in Figure I-3 below taken from GPSurvey shows which files were actually selected to be loaded for the project. In this example, all the observed lines were included.

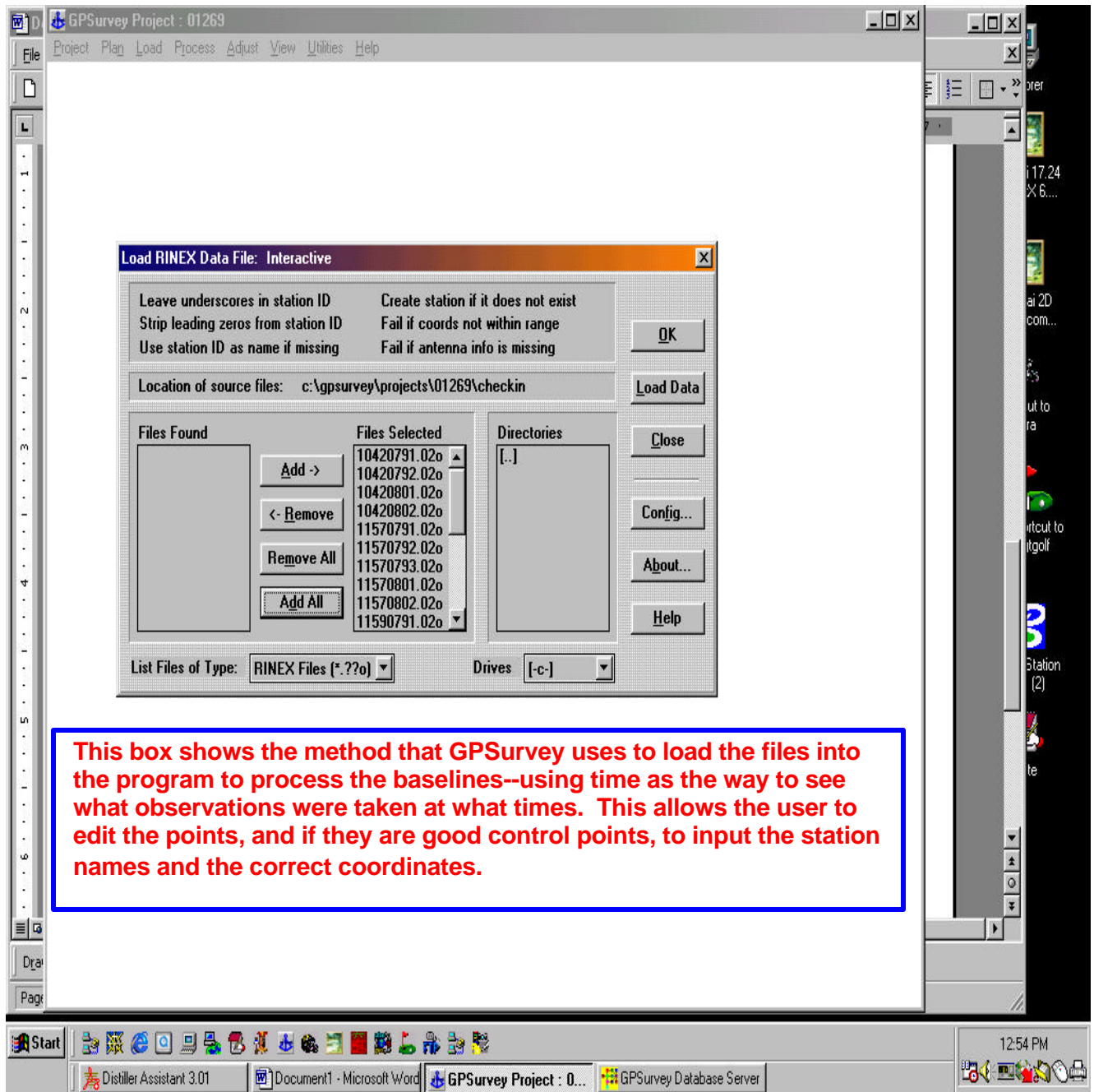

Figure I-3. Selected files for baseline processing

This screen in Figure I-4 shows the RINEX navigation file (e.g., *.02n) that is selected for the processing with the baseline file.

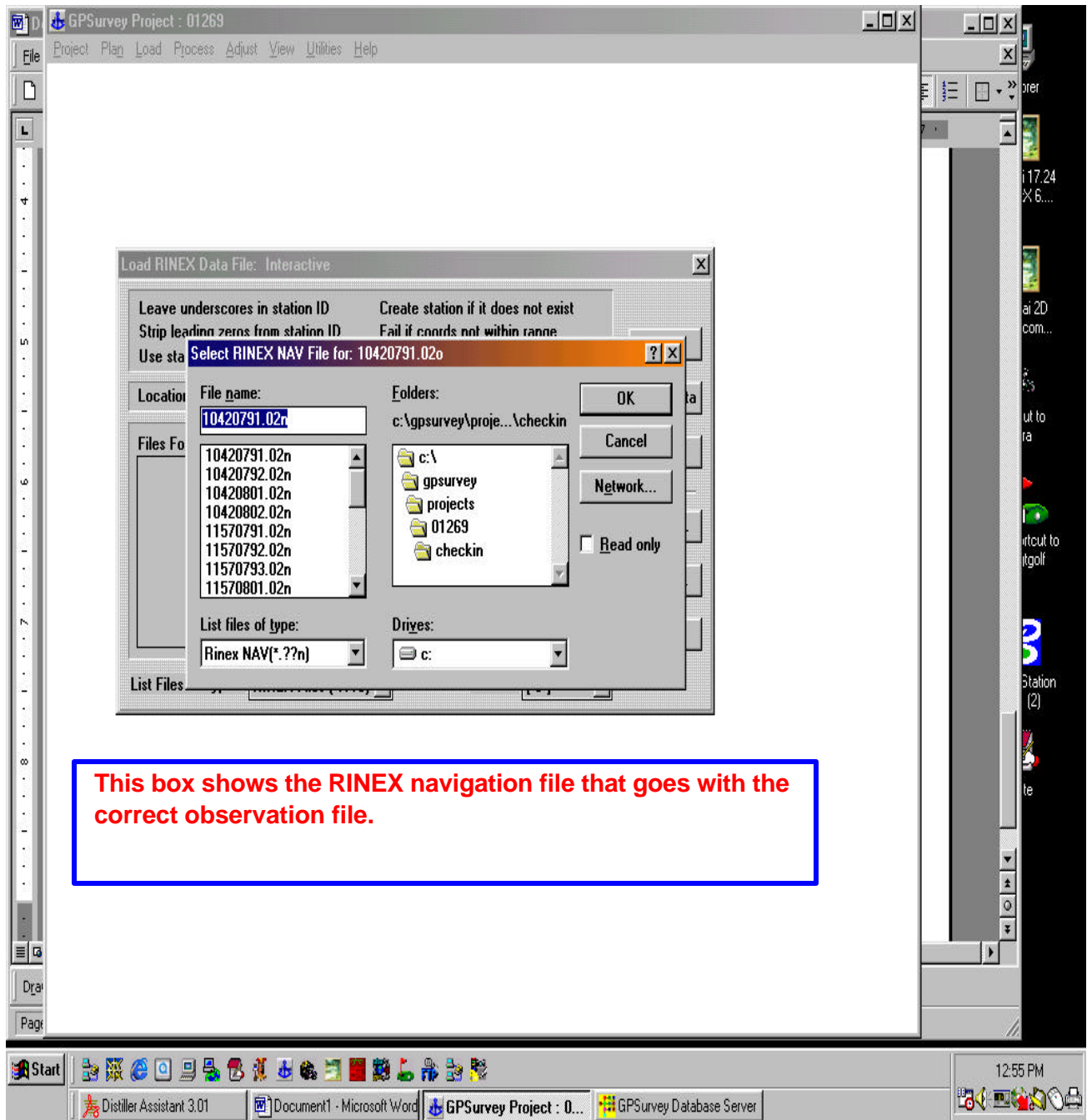

Figure I-4. Loading RINEX navigation files

This screen capture (Figure I-5) from the Trimble WAVE Baseline Processor shows what baselines will be processed using the times of the observation as the key to processing.

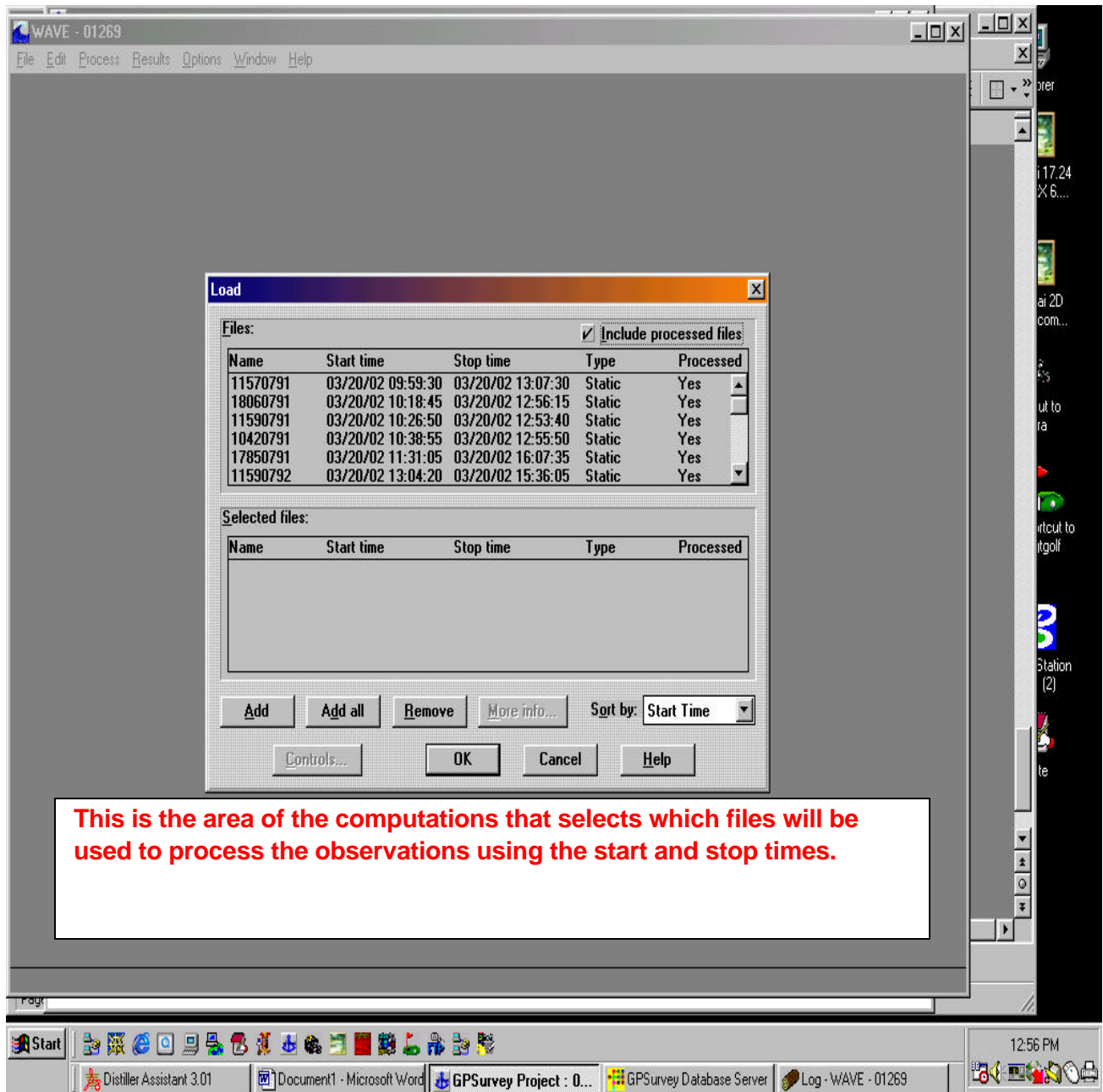

Figure I-5. Trimble WAVE Baseline Processor file listing

Figure I-6 depicts the files transferred and loaded for baseline processing. The files are sorted by observation time. All files were selected for processing.

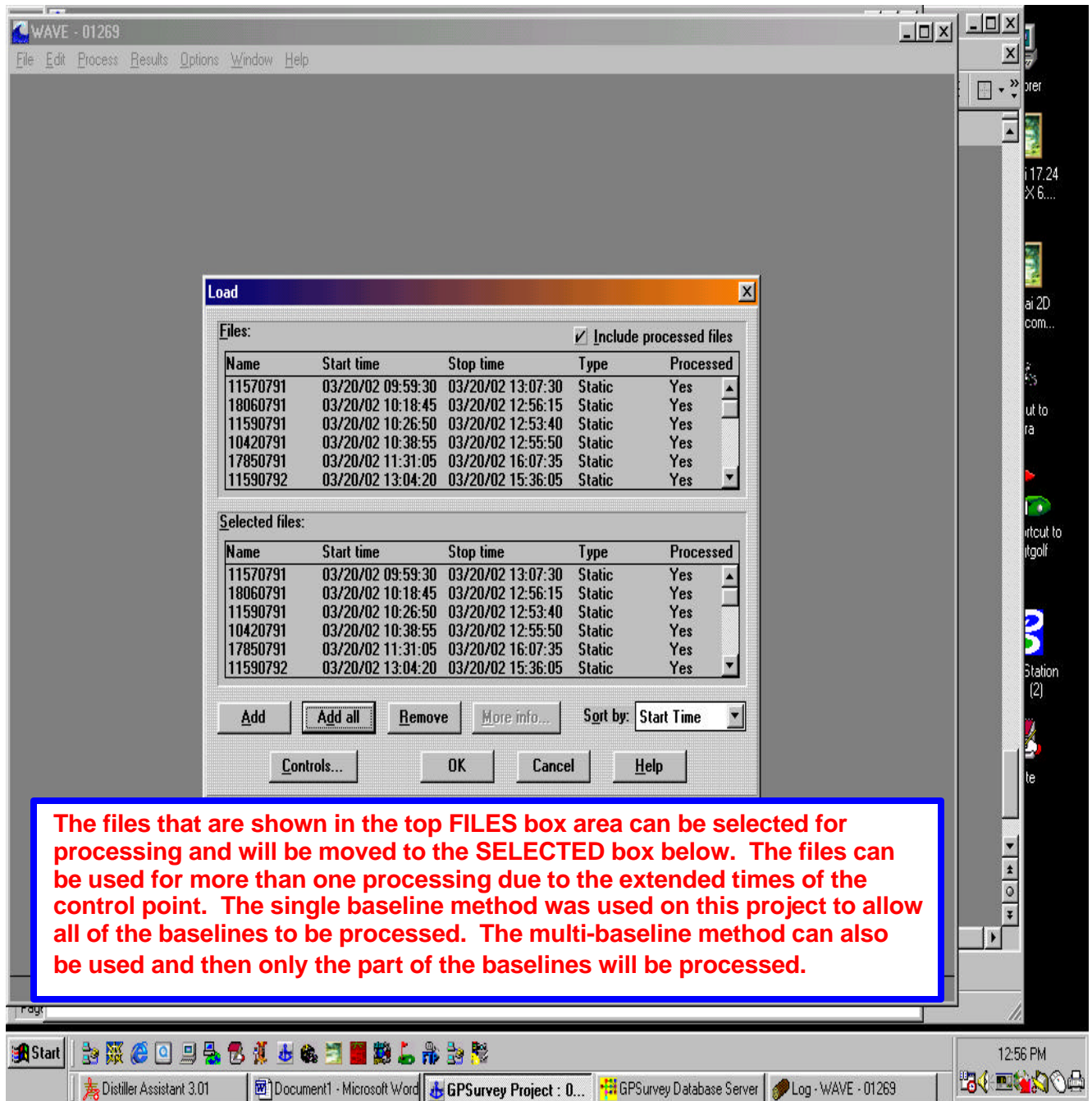

Figure I-6. Loaded files sorted by observation times

Figure I-7 shows the file loading status--with observation 11570791 currently loading.

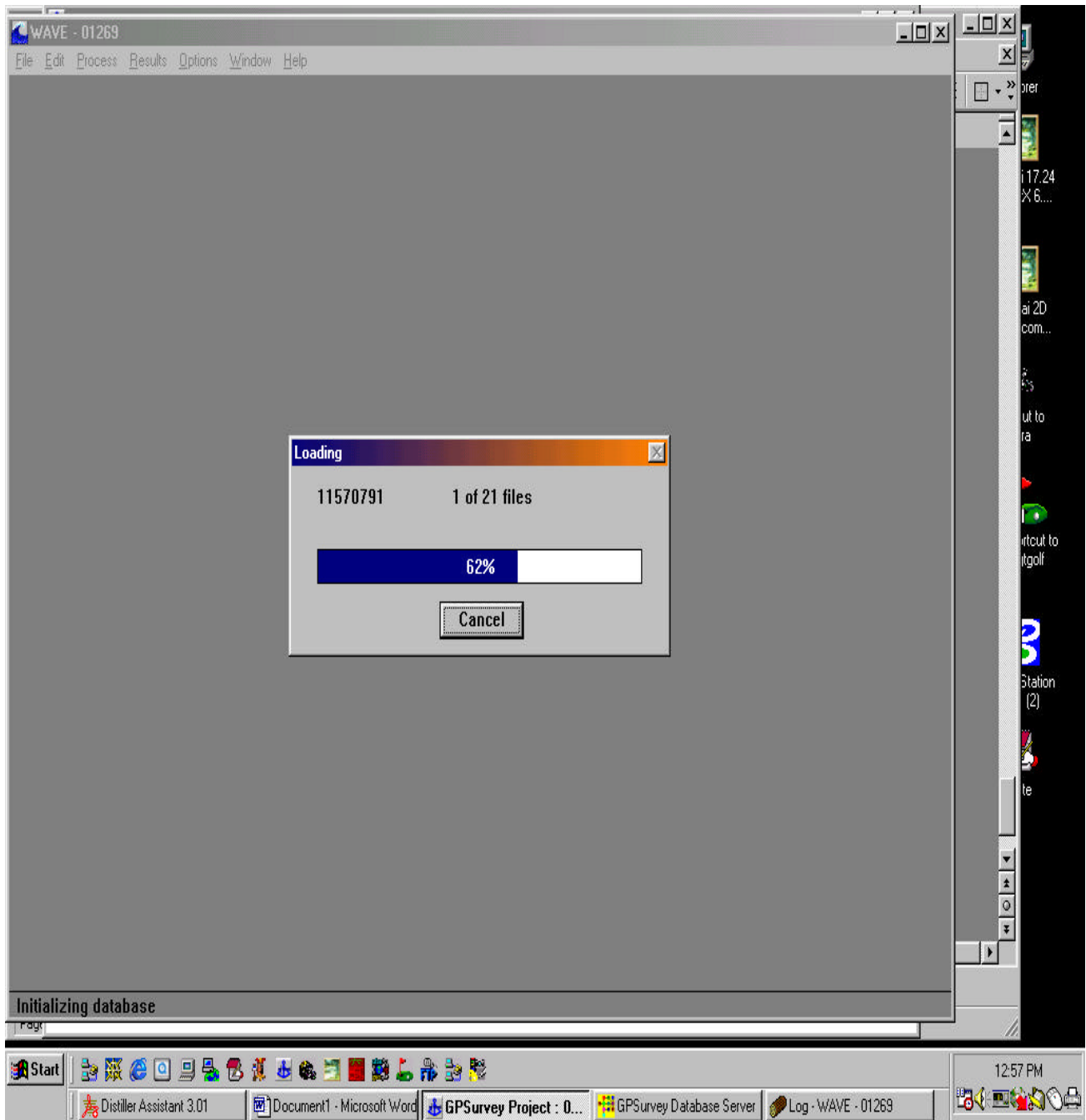

Figure I-7. Loading individual baseline observation files

I-2. Static Baseline Processing (Trimble WAVE Baseline Processor)

This screen (Figure I-8) shows the setup for processing static baseline observations. Start and stop times are indicated. In this example, "All Baselines" were selected. "Independent" or "User Defined" baselines could have been opted at this stage.

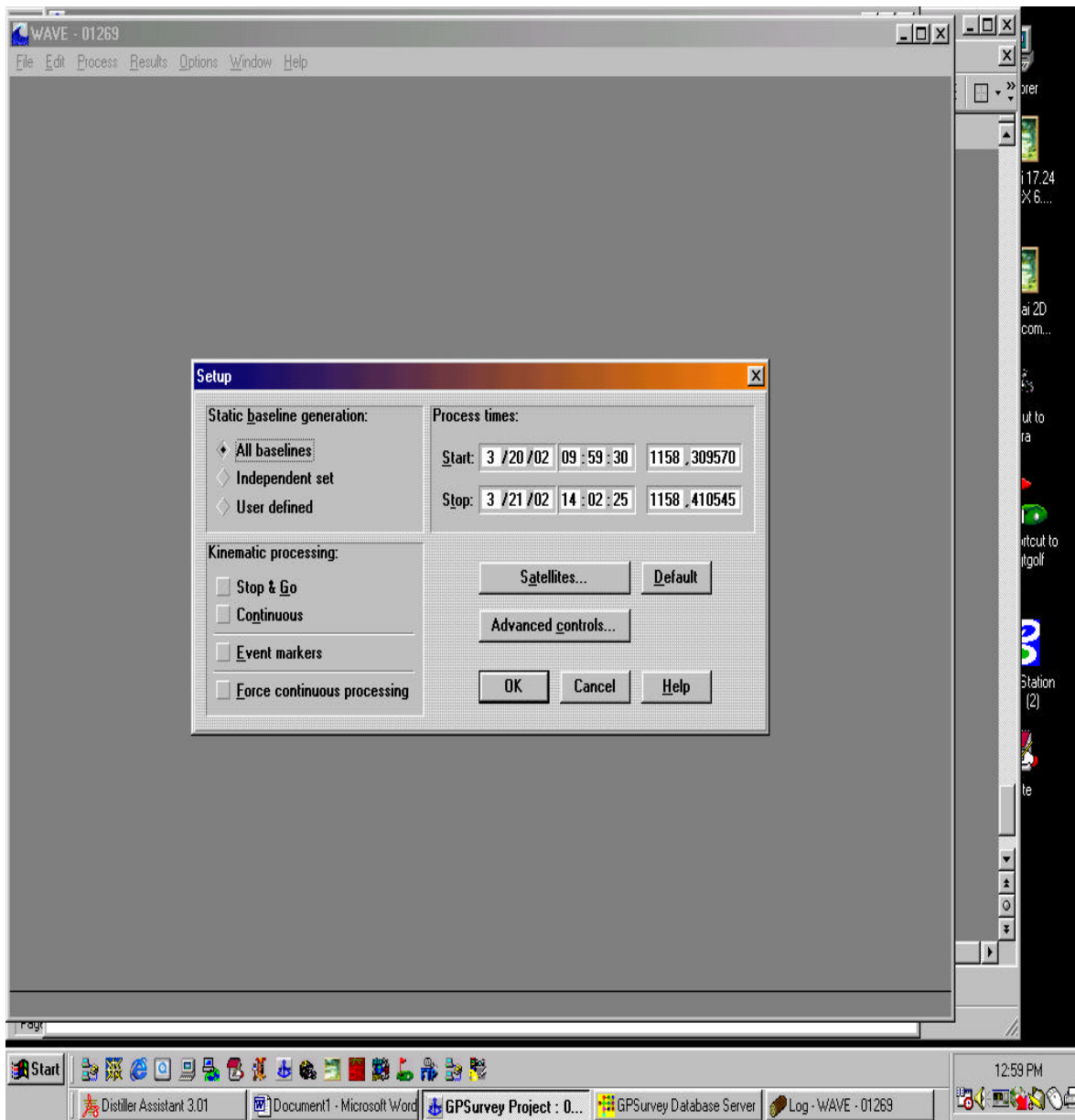

Figure I-8. WAVE setup for baselines to be processed

This screen capture (Figure I-9) shows the Advanced Control options that can be specified--e.g., satellite elevation mask, iterations, search times, etc. The Broadcast Ephemeris is selected in this example--if the Precise Ephemeris were available, then this file could have been loaded. Residual Generation and Antenna Phase Correction options are also turned on for these baseline reductions.

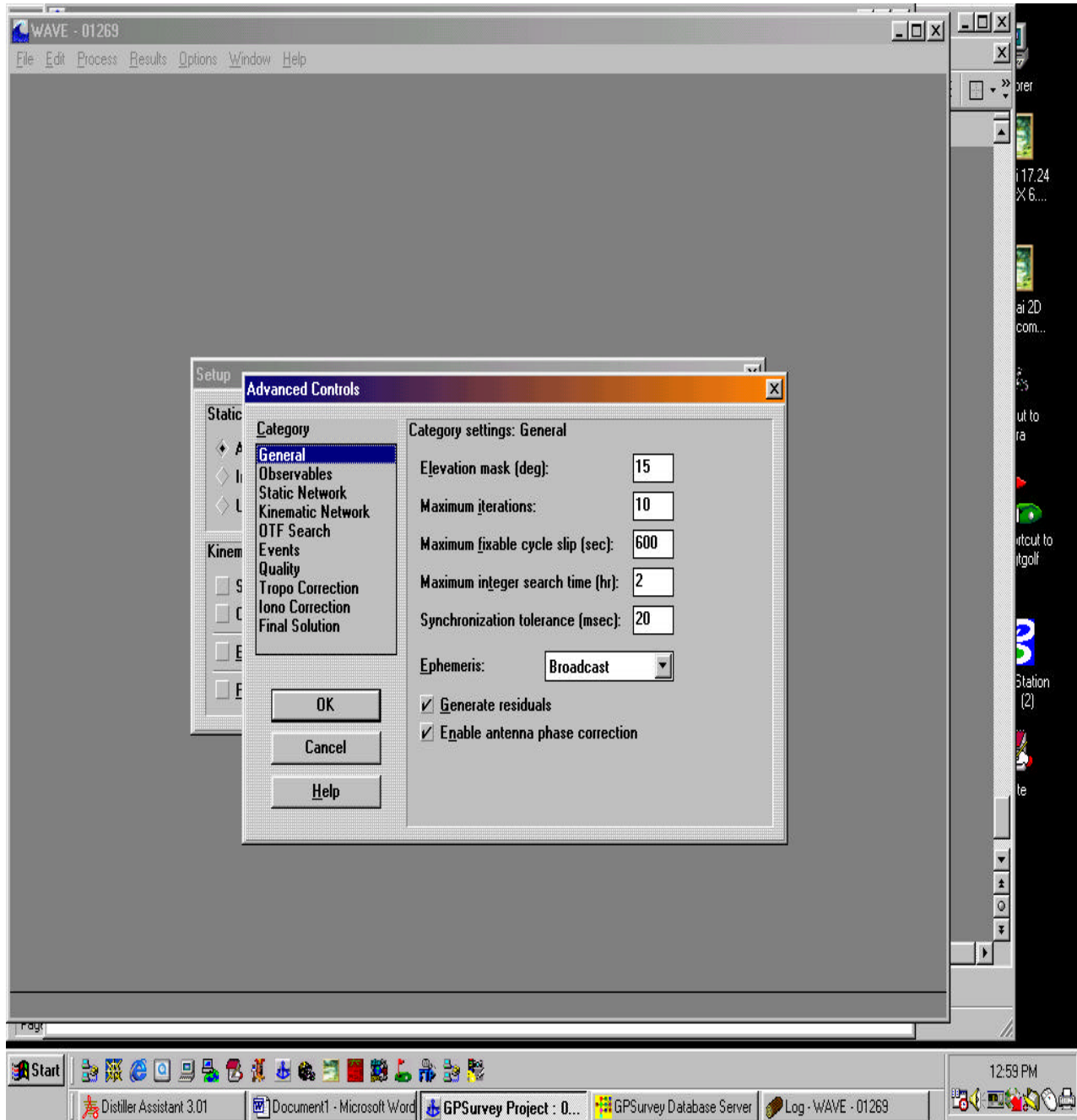

Figure I-9. Trimble WAVE Baseline Processor Advanced Controls screen

As baselines are being processed, this screen (Figure I-10) shows which specific baseline is currently being processed and its completion status.

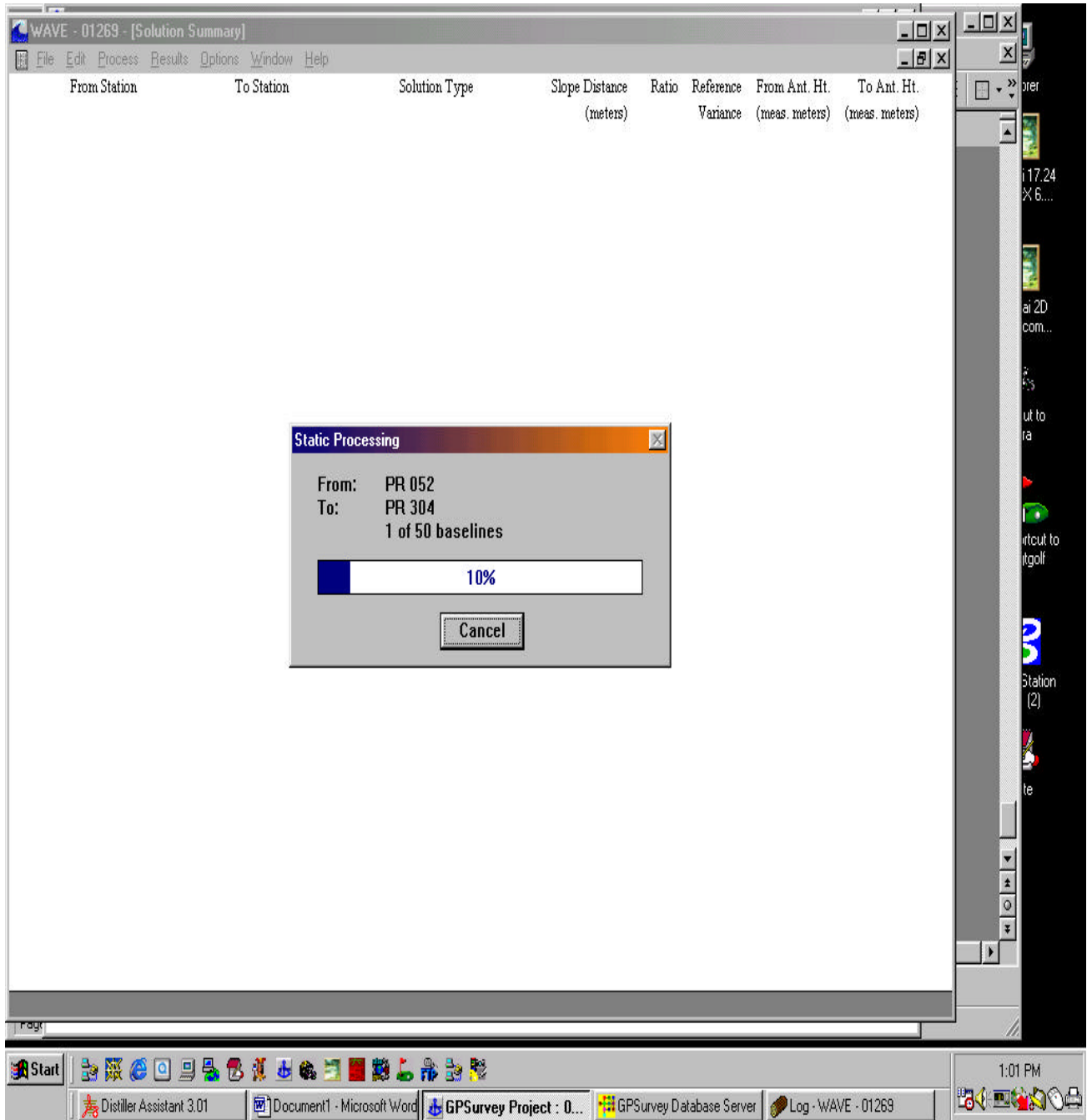

Figure I-10. Trimble WAVE Baseline Processor--Static Processing screen

As processing progresses, for each completed baseline the WAVE Baseline Processor outputs the display shown in Figure I-11 below. From Station, To Station, Solution Type, Slope Distance, Ratios, Reference Variances, and Antenna Height data are tabulated for code, triple, float and/or fixed solutions. The adequacy of the baseline solutions is evaluated from the resultant ratios and variances, as was described in Chapter 10. (A detailed baseline reduction summary report is not shown for lines on this project--see Chapter 10 for a typical example).

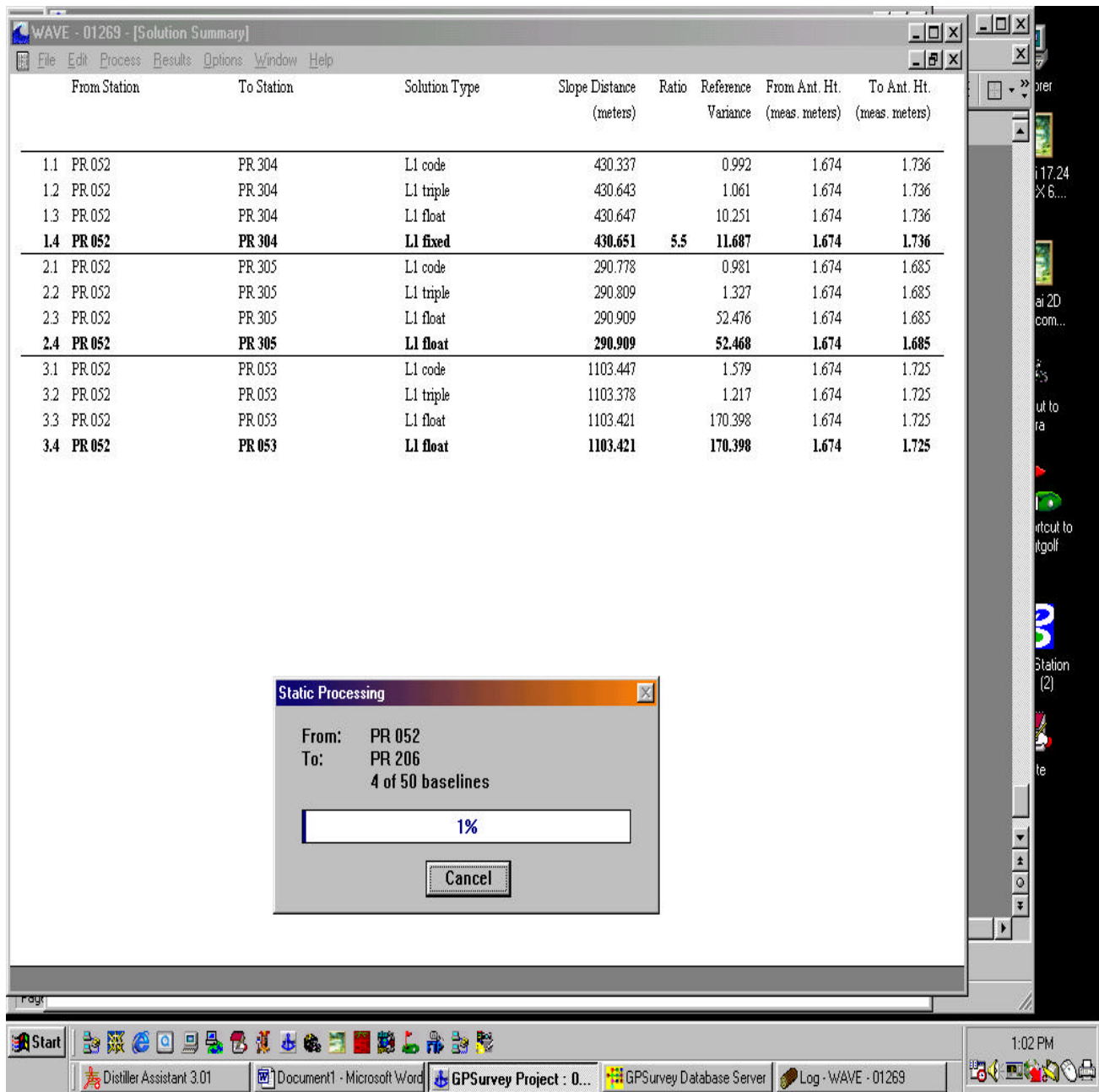

Figure I-11. Trimble WAVE Baseline Processor--Static Processing screen

I-3. Constrained Network Adjustment (Trimble GPSurvey)

Figure I-12 below shows the screen that starts the loading of all of the baselines into the GPS network for the free and final adjustments. During this process one can change the names of baselines if errors were made and were not put on the observation log sheets.

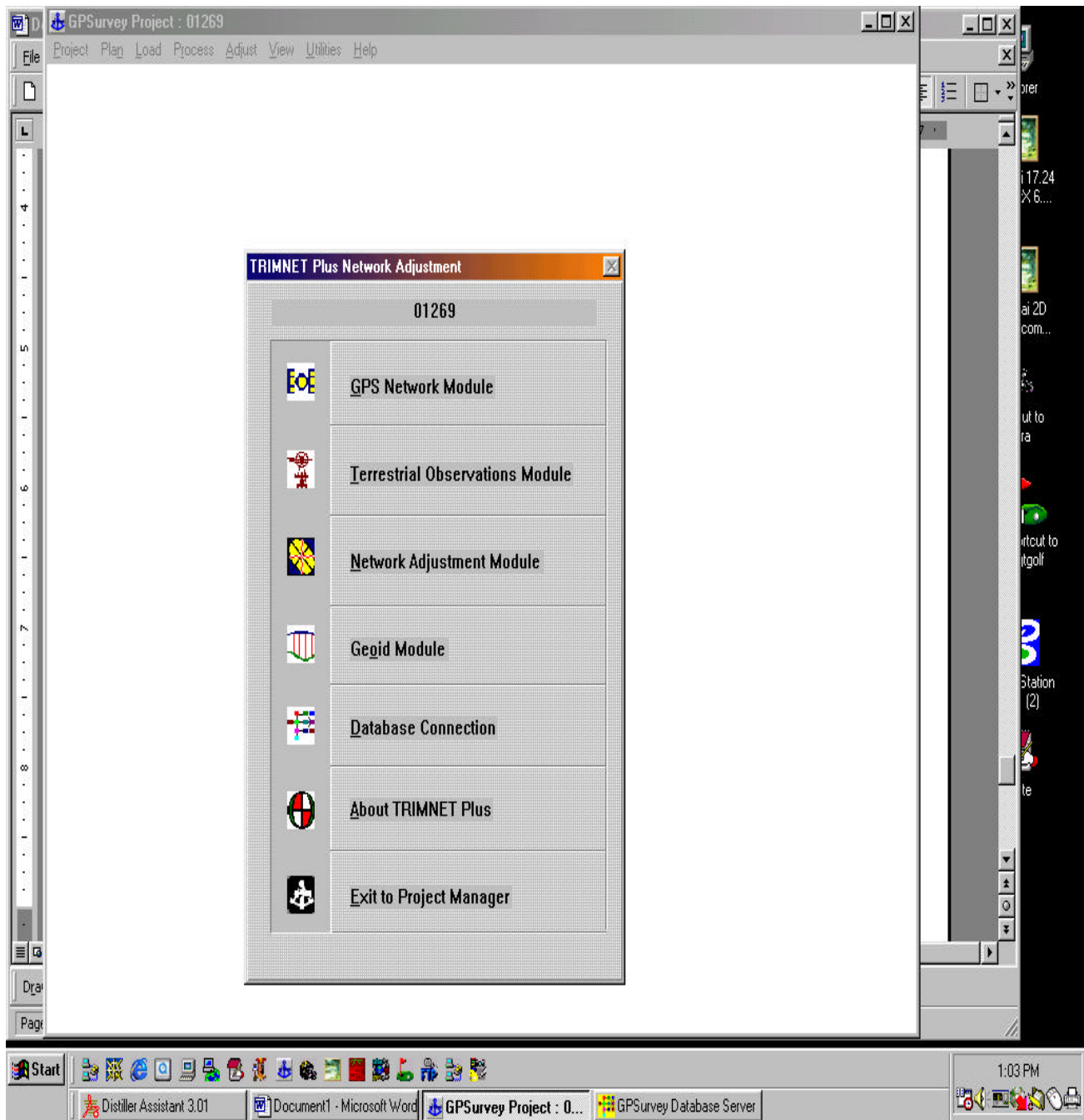

Figure I-12. Trimble GPSurvey option screen

Fixed values are set for the known control points. (Only 6 of the 9 fixed points are listed below). All are fixed in X, Y, and orthometric elevation, except point PR 054 which is fixed only in X-Y.

COORDINATE EDITING FIELD

PT#	NAME	NORTH/EAST	ELL(H)/ORTH(h)	FIX	KNWN
1 PR 052		215011.4802 232319.5773	-7.5431 33.8990	YX-h	YXHh
2 PR 053		216017.8960 232771.9230	4.0567 45.4270	YX-h	YXHh
3 PR 054		216466.5690 232394.4000	20.4581 61.7864	YX--	YXHh
4 PR 204		214840.3600 232081.2180	-10.9963 30.4390	YX-h	YXHh
5 PR 205		214972.4560 231867.1890	-10.4586 30.9650	YX-h	YXHh
6 PR 206		215719.3160 231966.5380	52.5379 93.8970	YX-h	YXHh

ESC=EXIT ENTER=SAVE ,TAB=CURSOR PgUp PgDn (ALT)F2-F5=(SET)CLEAR FIX

ADJUSTMENT ACTIVITY LOG
NETWORK = 01269
TIME = Tue Aug 20 13:09:54 2002

Adjustment process underway.
Computing closures.
Closures have been computed.
Indexing observation equations and unknowns.
Number of sub-networks = 1.
Number of inner constraints sub-network 1 = 0.

Sub-network 1: Fixed y = 9 Fixed x = 9 Fixed H = 0
Fixed h = 8.

Points included in sub-network 1:

PR 052
PR 053
PR 054
PR 204
PR 205
PR 206
PR 209
PR 210
PR 211
PR 303
PR 304
PR 305
PR 306
PR 307

Initializing parameter group 1: GPS Observations.

90 horizontal observations
45 vertical observations
45 observed azimuths
45 observed distances
Located in sub-network 1.
9 fixed latitudes
9 fixed longitudes
0 fixed ellipsoid heights
8 fixed orthometric heights
Y rotation parameter 1 = 31.
X rotation parameter 2 = 32.
Azimuth rotation parameter 3 = 33.
Network scale parameter 4 = 34.
Omitting parameter 5 by user choice
Omitting parameter 6 by user choice
Omitting parameter 7 by user choice

Initializing parameter group 3: Geoid Model.

0 horizontal observations
14 vertical observations
0 observed azimuths
0 observed distances
Located in sub-network 0.
0 fixed latitudes
0 fixed longitudes
0 fixed ellipsoid heights
8 fixed orthometric heights
Transformation 1 ruled ineligible.

Transformation 2 ruled ineligible.
Transformation 3 ruled ineligible.
Transformation 4 ruled ineligible.
Transformation 5 ruled ineligible.
Transformation 6 ruled ineligible.
Transformation 7 ruled ineligible.

Number of fixed horizontal coordinates = 18.
Number of fixed vertical coordinates = 8.
Number of observation equations = 149.
Number of vertical observation equations = 59.
Number of unknowns = 34.
Number of inner constraint equations = 0.
The following observations are excluded from the adjustment:
39
40
41

The following points were excluded from the adjustment:
none

Proceeding with observation equations.
Turning on graphics before going into adjustment iteration.

Beginning adjustment iteration 1.
Forming observation equations.
Performing observation covariance inverses.
Forming constants and normal equations.
Computing normals inverse.
Computing observation residuals.
Solutions from iteration 1:

1 2.854913e-005
2 -2.935114e-005
3 -9.454666e-006
4 -1.135234e-006
5 -1.135234e-006
6 1.091846e-007
7 2.731083e-008
8 -5.073252e-006
9 1.715210e-005
10 1.715210e-005
11 -1.007466e-006
12 4.382808e-007
13 6.931903e-006
14 6.931903e-006
15 6.961781e-007
16 -2.403132e-007
17 8.987806e-006
18 1.346934e-005
19 1.346934e-005
20 2.070258e-005
21 1.626538e-005
22 1.626538e-005

ADJUSTMENT ACTIVITY LOG
(Continued)

23 -1.993965e-005
24 -4.512070e-007
25 -1.089678e-005
26 -3.463680e-006
27 -4.153571e-006

28 -4.153571e-006
29 6.861524e-007
30 -1.480108e-007
31 2.050461e-004
32 1.875429e-003
33 6.811946e-005
34 -6.488047e-010

Recomputing closures for check on residuals

Iteration check on residuals (tolerance = 1.0e-005):

eq #	1	obs #	1	=	-1.172920e-002	-	-1.172920e-002	=	+1.809317e-015
eq #	2	obs #	2	=	-2.725732e-003	-	-2.725732e-003	=	+3.192759e-015
eq #	3	obs #	3	=	-3.388132e-021	-	+0.000000e+000	=	+3.388132e-021
eq #	4	obs #	4	=	+2.743241e-003	-	+2.743241e-003	=	+4.312089e-015
eq #	5	obs #	5	=	+1.184806e-003	-	+1.184806e-003	=	+1.869165e-016
eq #	6	obs #	6	=	+1.445093e-002	-	+1.445093e-002	=	+1.059916e-015
eq #	7	obs #	7	=	-9.747927e-003	-	-9.747927e-003	=	+5.759282e-016
eq #	8	obs #	8	=	+1.903540e-003	-	+1.903540e-003	=	+1.575563e-015
eq #	9	obs #	9	=	+3.920341e-003	-	+3.920341e-003	=	+1.554312e-015
eq #	10	obs #	10	=	+0.000000e+000	-	+0.000000e+000	=	+0.000000e+000
eq #	11	obs #	11	=	-8.470329e-022	-	+0.000000e+000	=	+8.470329e-022
eq #	12	obs #	12	=	+2.117582e-022	-	+0.000000e+000	=	+2.117582e-022
eq #	13	obs #	13	=	+0.000000e+000	-	+0.000000e+000	=	+0.000000e+000
eq #	14	obs #	14	=	+6.776264e-021	-	+0.000000e+000	=	+6.776264e-021
eq #	15	obs #	15	=	-6.987002e-001	-	-6.987002e-001	=	+3.958023e-011
eq #	16	obs #	16	=	+3.973133e-003	-	+3.973130e-003	=	+3.200652e-009
eq #	17	obs #	17	=	+5.760878e-002	-	+5.760878e-002	=	+1.616346e-013
eq #	18	obs #	18	=	+1.586500e+000	-	+1.586500e+000	=	+5.998612e-008
eq #	19	obs #	19	=	-2.164304e-002	-	-2.164304e-002	=	+5.047094e-009
eq #	20	obs #	20	=	+6.403900e-003	-	+6.403901e-003	=	+7.033141e-010
eq #	21	obs #	21	=	+2.027594e+000	-	+2.027594e+000	=	+2.697398e-011
eq #	22	obs #	22	=	+4.625992e-002	-	+4.625992e-002	=	+5.238827e-010
eq #	23	obs #	23	=	-6.325114e-003	-	-6.325114e-003	=	+1.996675e-013
eq #	24	obs #	24	=	+9.153852e+000	-	+9.153853e+000	=	+3.238207e-007
eq #	25	obs #	25	=	+6.079804e-003	-	+6.079805e-003	=	+1.324542e-009
eq #	26	obs #	26	=	+1.030900e-002	-	+1.030900e-002	=	+2.308817e-010
eq #	27	obs #	27	=	-1.284557e+001	-	-1.284557e+001	=	+4.230263e-007
eq #	28	obs #	28	=	+1.100492e-002	-	+1.100492e-002	=	+1.224835e-009
eq #	29	obs #	29	=	+3.674400e-002	-	+3.674400e-002	=	+5.064874e-010
eq #	30	obs #	30	=	+9.199836e+000	-	+9.199836e+000	=	+6.668890e-007
eq #	31	obs #	31	=	+7.156526e-002	-	+7.156526e-002	=	+1.585227e-009
eq #	32	obs #	32	=	-8.199078e-003	-	-8.199080e-003	=	+2.176101e-009
eq #	33	obs #	33	=	+3.572660e+000	-	+3.572660e+000	=	+6.910694e-011
eq #	34	obs #	34	=	-6.813613e-002	-	-6.813613e-002	=	+4.435793e-009
eq #	35	obs #	35	=	+1.161688e-002	-	+1.161688e-002	=	+1.747977e-013
eq #	36	obs #	36	=	-4.230644e+001	-	-4.230644e+001	=	+2.053469e-012
eq #	37	obs #	37	=	-6.084741e-002	-	-6.084741e-002	=	+8.463078e-010
eq #	38	obs #	38	=	+1.902216e-002	-	+1.902216e-002	=	+9.575674e-016
eq #	39	obs #	42	=	+6.152651e+000	-	+6.152651e+000	=	+5.531042e-011
eq #	40	obs #	43	=	-4.564548e-003	-	-4.564547e-003	=	+1.372292e-009
eq #	41	obs #	44	=	-5.731869e-003	-	-5.731869e-003	=	+1.098175e-013
eq #	42	obs #	45	=	-7.877954e-001	-	-7.877955e-001	=	+1.334509e-007
eq #	43	obs #	46	=	+3.354646e-002	-	+3.354646e-002	=	+1.968335e-009
eq #	44	obs #	47	=	+1.752018e-002	-	+1.752019e-002	=	+5.410225e-010
eq #	45	obs #	48	=	+6.442804e-001	-	+6.442799e-001	=	+4.696995e-007
eq #	46	obs #	49	=	-8.173709e-003	-	-8.173708e-003	=	+6.671547e-010
eq #	47	obs #	50	=	+4.028200e-003	-	+4.028195e-003	=	+4.943828e-009
eq #	48	obs #	51	=	+7.818527e+001	-	+7.818527e+001	=	+5.998611e-008
eq #	49	obs #	52	=	+4.574225e-001	-	+4.574225e-001	=	+5.047094e-009
eq #	50	obs #	53	=	-2.897678e-001	-	-2.897678e-001	=	+7.036552e-010

ADJUSTMENT ACTIVITY LOG (Continued)

eq #	51 obs #	54 =	-1.433430e+000	-	-1.433430e+000	=	+2.697398e-011
eq #	52 obs #	55 =	+1.431538e-002	-	+1.431537e-002	=	+5.238827e-010
eq #	53 obs #	56 =	-7.738471e-004	-	-7.738471e-004	=	+1.996680e-013
eq #	54 obs #	57 =	-6.310346e+001	-	-6.310346e+001	=	+4.630607e-011
eq #	55 obs #	58 =	+5.137484e-001	-	+5.137484e-001	=	+1.054321e-009
eq #	56 obs #	59 =	-2.815387e-001	-	-2.815387e-001	=	+1.278977e-013
eq #	57 obs #	60 =	+8.221172e+001	-	+8.221172e+001	=	+1.446183e-007
eq #	58 obs #	61 =	+3.601027e-001	-	+3.601027e-001	=	+1.398636e-009
eq #	59 obs #	62 =	-2.123748e-001	-	-2.123748e-001	=	+1.761587e-009
eq #	60 obs #	63 =	+1.433463e+002	-	+1.433463e+002	=	+2.587701e-007
eq #	61 obs #	64 =	+3.651871e-001	-	+3.651871e-001	=	+3.239688e-009
eq #	62 obs #	65 =	-7.682988e-002	-	-7.682989e-002	=	+4.859315e-010
eq #	63 obs #	66 =	-8.057405e+000	-	-8.057408e+000	=	+2.663404e-006
eq #	64 obs #	67 =	-2.428793e-002	-	-2.428794e-002	=	+1.056293e-008
eq #	65 obs #	68 =	+1.022291e-002	-	+1.022291e-002	=	+2.236477e-009
eq #	66 obs #	69 =	+1.043459e+000	-	+1.043459e+000	=	+4.850657e-007
eq #	67 obs #	70 =	+3.335514e-002	-	+3.335514e-002	=	+6.000156e-009
eq #	68 obs #	71 =	-3.885174e-003	-	-3.885173e-003	=	+1.363619e-009
eq #	69 obs #	72 =	-2.530377e+001	-	-2.530377e+001	=	+5.300641e-007
eq #	70 obs #	73 =	+1.943408e-001	-	+1.943408e-001	=	+1.436075e-009
eq #	71 obs #	74 =	+5.981976e-002	-	+5.981976e-002	=	+6.784776e-010
eq #	72 obs #	75 =	-3.876707e+002	-	-3.876707e+002	=	+6.668890e-007
eq #	73 obs #	76 =	-5.318146e-001	-	-5.318146e-001	=	+1.585227e-009
eq #	74 obs #	77 =	-1.246179e-001	-	-1.246179e-001	=	+2.177010e-009
eq #	75 obs #	78 =	-4.999991e+000	-	-4.999992e+000	=	+2.567016e-007
eq #	76 obs #	79 =	-8.464778e-004	-	-8.464774e-004	=	+4.184973e-010
eq #	77 obs #	80 =	+5.878313e-002	-	+5.878313e-002	=	+3.522176e-010
eq #	78 obs #	81 =	-3.041574e+001	-	-3.041574e+001	=	+1.918465e-013
eq #	79 obs #	82 =	+6.040496e-001	-	+6.040496e-001	=	+8.466833e-010
eq #	80 obs #	83 =	-7.491374e-002	-	-7.491374e-002	=	+2.220446e-016
eq #	81 obs #	84 =	-8.818368e+000	-	-8.818368e+000	=	+6.838974e-013
eq #	82 obs #	85 =	+5.804676e-002	-	+5.804676e-002	=	+1.436223e-009
eq #	83 obs #	86 =	-5.248905e-002	-	-5.248905e-002	=	+7.896461e-015
eq #	84 obs #	87 =	-1.775986e+001	-	-1.775986e+001	=	+6.124193e-007
eq #	85 obs #	88 =	+7.135368e-002	-	+7.135368e-002	=	+1.861621e-009
eq #	86 obs #	89 =	-4.440025e-002	-	-4.440025e-002	=	+5.002584e-010
eq #	87 obs #	90 =	-6.772805e+000	-	-6.772805e+000	=	+1.807343e-007
eq #	88 obs #	91 =	-7.871768e-003	-	-7.871767e-003	=	+1.556578e-009
eq #	89 obs #	92 =	-8.291872e-003	-	-8.291872e-003	=	+3.354864e-010
eq #	90 obs #	93 =	-1.806235e+001	-	-1.806235e+001	=	+1.588827e-006
eq #	91 obs #	94 =	-4.562904e-003	-	-4.562893e-003	=	+1.067908e-008
eq #	92 obs #	95 =	-4.474693e-003	-	-4.474691e-003	=	+2.553851e-009
eq #	93 obs #	96 =	+1.623485e+000	-	+1.623485e+000	=	+5.698642e-011
eq #	94 obs #	97 =	+2.373179e-002	-	+2.373180e-002	=	+1.653033e-009
eq #	95 obs #	98 =	+2.825941e-003	-	+2.825941e-003	=	+2.628063e-014
eq #	96 obs #	99 =	-1.054534e+001	-	-1.054534e+001	=	+1.824318e-012
eq #	97 obs #	100 =	-2.877803e-002	-	-2.877803e-002	=	+1.195649e-009
eq #	98 obs #	101 =	-4.835661e-002	-	-4.835661e-002	=	+4.281298e-015
eq #	99 obs #	102 =	-8.425857e+001	-	-8.425857e+001	=	+9.947598e-014
eq #	100 obs #	103 =	+3.183408e-001	-	+3.183408e-001	=	+8.360663e-010
eq #	101 obs #	104 =	+1.388665e-001	-	+1.388665e-001	=	+8.049117e-016
eq #	102 obs #	105 =	-2.764462e-001	-	-2.764464e-001	=	+2.750273e-007
eq #	103 obs #	106 =	-1.645783e-002	-	-1.645783e-002	=	+2.075703e-009
eq #	104 obs #	107 =	-9.338660e-003	-	-9.338667e-003	=	+7.330924e-009
eq #	105 obs #	108 =	-6.531868e+000	-	-6.531868e+000	=	+1.349563e-007
eq #	106 obs #	109 =	-2.225955e-002	-	-2.225956e-002	=	+2.050959e-009
eq #	107 obs #	110 =	-4.099432e-002	-	-4.099433e-002	=	+4.002003e-009
eq #	108 obs #	111 =	-9.038680e+001	-	-9.038680e+001	=	+3.029304e-007
eq #	109 obs #	112 =	+2.265426e-001	-	+2.265425e-001	=	+2.131102e-009
eq #	110 obs #	113 =	+1.169143e-001	-	+1.169143e-001	=	+2.070887e-009

ADJUSTMENT ACTIVITY LOG (Concluded)

eq # 111 obs # 114 = +2.037355e+001 - +2.037355e+001 = +2.851333e-007
eq # 112 obs # 115 = +9.310192e-003 - +9.310186e-003 = +6.041398e-009
eq # 113 obs # 116 = +4.737690e-003 - +4.737689e-003 = +1.041203e-009
eq # 114 obs # 117 = -1.192683e+002 - -1.192683e+002 = +1.931255e-011
eq # 115 obs # 118 = +2.685878e-001 - +2.685878e-001 = +5.685091e-009
eq # 116 obs # 119 = +3.448002e-001 - +3.448002e-001 = +2.232659e-013
eq # 117 obs # 120 = -4.574976e+002 - -4.574976e+002 = +5.053889e-007
eq # 118 obs # 121 = +1.969103e-001 - +1.969103e-001 = +8.038071e-010
eq # 119 obs # 122 = +4.035390e-001 - +4.035390e-001 = +5.586175e-010
eq # 120 obs # 123 = +4.347293e+000 - +4.347293e+000 = +6.027581e-007
eq # 121 obs # 124 = +2.905365e-002 - +2.905365e-002 = +4.957338e-009
eq # 122 obs # 125 = +9.965576e-003 - +9.965577e-003 = +8.288416e-010
eq # 123 obs # 126 = -3.646539e+000 - -3.646539e+000 = +1.978812e-008
eq # 124 obs # 127 = -2.164740e-002 - -2.164740e-002 = +2.524004e-010
eq # 125 obs # 128 = -1.541062e-002 - -1.541062e-002 = +1.220997e-009
eq # 126 obs # 129 = +9.490985e+000 - +9.490985e+000 = +2.209788e-012
eq # 127 obs # 130 = +3.390364e-002 - +3.390364e-002 = +2.073581e-009
eq # 128 obs # 131 = +2.135251e-001 - +2.135251e-001 = +1.421085e-014
eq # 129 obs # 132 = -2.072900e+001 - -2.072900e+001 = +2.623430e-010
eq # 130 obs # 133 = +2.839774e-002 - +2.839773e-002 = +9.410564e-009
eq # 131 obs # 134 = +1.905402e-002 - +1.905402e-002 = +1.155499e-013
eq # 132 obs # 135 = +5.346306e+001 - +5.346306e+001 = +1.856001e-006
eq # 133 obs # 136 = -4.327163e-002 - -4.327162e-002 = +1.013239e-008
eq # 134 obs # 137 = -2.995442e-003 - -2.995444e-003 = +2.334752e-009
eq # 135 obs # 138 = +9.531944e-001 - +9.531939e-001 = +5.226953e-007
eq # 136 obs # 139 = -5.585728e-003 - -5.585722e-003 = +5.518201e-009
eq # 137 obs # 140 = +7.454290e-003 - +7.454295e-003 = +4.226804e-009
eq # 138 obs # 141 = +2.174733e-001 - +2.174733e-001 = +2.825215e-011
eq # 139 obs # 142 = +1.392240e-002 - +1.392241e-002 = +3.276267e-009
eq # 140 obs # 143 = +2.256987e-002 - +2.256987e-002 = +1.521283e-013
eq # 141 obs # 144 = +1.819094e+000 - +1.819094e+000 = +3.490333e-007
eq # 142 obs # 145 = +2.807063e-002 - +2.807064e-002 = +6.859983e-009
eq # 143 obs # 146 = +2.239743e-003 - +2.239741e-003 = +1.289568e-009
eq # 144 obs # 147 = -1.721200e+001 - -1.721200e+001 = +1.612694e-006
eq # 145 obs # 148 = +7.842632e-003 - +7.842637e-003 = +4.262680e-009
eq # 146 obs # 149 = -3.978830e-003 - -3.978828e-003 = +2.201065e-009
eq # 147 obs # 150 = -6.138768e+000 - -6.138769e+000 = +7.859648e-007
eq # 148 obs # 151 = +2.141678e-002 - +2.141677e-002 = +5.741399e-010
eq # 149 obs # 152 = +8.847308e-003 - +8.847305e-003 = +2.683643e-009

Successful adjustment 1 iterations
Beginning adjustment summary in stats.log.
Beginning coordinate adjustment in coords.log.
Coordinate adjustment summary complete.
Beginning plots of error ellipses.
Ellipse plotting complete.
Proceeding with adjustment of observations.
Observation adjustment complete.
Statistics summary complete.
Plot histograms.
Histogram plotting complete.
Computing covariances in azimuth, distance and height.
Covariance processing complete.
Iterations complete, so turning graphics off.
Graphics turned off.
Closing activity log.
TIME = Tue Aug 20 13:09:56 2002.

CLOSURES LOG
NETWORK = 01269
TIME = Tue Aug 20 13:09:54 2002

OBS# TYPE BACKSIGHT FORESIGHT CLOSURE TRANSFORM

1	hgoid	PR 052	-0.011729m	0.000000m
2	hgoid	PR 053	-0.002726m	0.000000m
3	hgoid	PR 054	0.000000m	0.000000m
4	hgoid	PR 204	0.002743m	0.000000m
5	hgoid	PR 205	0.001185m	0.000000m
6	hgoid	PR 206	0.014451m	0.000000m
7	hgoid	PR 209	-0.009748m	0.000000m
8	hgoid	PR 210	0.001904m	0.000000m
9	hgoid	PR 211	0.003920m	0.000000m
10	hgoid	PR 303	0.000000m	0.000000m
11	hgoid	PR 304	0.000000m	0.000000m
12	hgoid	PR 305	0.000000m	0.000000m
13	hgoid	PR 306	0.000000m	0.000000m
14	hgoid	PR 307	0.000000m	0.000000m
15	gpsaz	PR 206	PR 204	-0.698700" -3.394764"
16	gpsht	PR 206	PR 204	0.003973m -0.228487m
17	gpsds	PR 206	PR 204	0.057609m 0.083265m
18	gpsaz	PR 206	PR 305	1.586500" -3.391457"
19	gpsht	PR 206	PR 305	-0.021643m -0.216107m
20	gpsds	PR 206	PR 305	0.006404m 0.054952m
21	gpsaz	PR 206	PR 052	2.027594" -3.393058"
22	gpsht	PR 206	PR 052	0.046260m -0.263303m
23	gpsds	PR 206	PR 052	-0.006325m 0.074304m
24	gpsaz	PR 305	PR 205	9.153853" -3.394245"
25	gpsht	PR 305	PR 205	0.006080m 0.082280m
26	gpsds	PR 305	PR 205	0.010309m 0.056380m
27	gpsaz	PR 305	PR 204	-12.845573" -3.394136"
28	gpsht	PR 305	PR 204	0.011005m -0.011935m
29	gpsds	PR 305	PR 204	0.036744m 0.050882m
30	gpsaz	PR 305	PR 052	9.199836" -3.392437"
31	gpsht	PR 305	PR 052	0.071565m -0.046754m
32	gpsds	PR 305	PR 052	-0.008199m 0.027313m
33	gpsaz	PR 052	PR 205	3.572660" -3.392647"
34	gpsht	PR 052	PR 205	-0.068136m 0.129742m
35	gpsds	PR 052	PR 205	0.011617m 0.042640m
36	gpsaz	PR 052	PR 204	-42.306444" -3.392533"
37	gpsht	PR 052	PR 204	-0.060847m 0.035526m
38	gpsds	PR 052	PR 204	0.019022m 0.027557m
39	gpsaz	PR 204	PR 205	31.946543" -3.390954"
40	gpsht	PR 204	PR 205	-0.010386m 0.095248m
41	gpsds	PR 204	PR 205	0.062515m 0.023619m
42	gpsaz	PR 206	PR 205	6.152651" -3.394882"
43	gpsht	PR 206	PR 205	-0.004565m -0.134274m
44	gpsds	PR 206	PR 205	-0.005732m 0.070769m
45	gpsaz	PR 206	PR 307	-0.787796" -3.386272"
46	gpsht	PR 206	PR 307	0.033546m -0.101236m
47	gpsds	PR 206	PR 307	0.017520m 0.074743m
48	gpsaz	PR 206	PR 304	0.644280" -3.390719"
49	gpsht	PR 206	PR 304	-0.008174m -0.189596m
50	gpsds	PR 206	PR 304	0.004028m 0.047512m
51	gpsaz	PR 206	PR 305	78.185273" -3.391457"
52	gpsht	PR 206	PR 305	0.457422m -0.216107m

Geoid Model
Closures

GPS Baseline
Closures

azimuth (")
height (m)
distance (m)

Excluded from
adjustment

1 Jul 03

CLOSURES LOG (Continued)

OBS#	TYPE	BACKSIGHT	FORESIGHT	CLOSURE	TRANSFORM
53	gpsds	PR 206	PR 305	-0.289768m	0.054952m
54	gpsaz	PR 206	PR 052	-1.433430"	-3.393058"
55	gpsht	PR 206	PR 052	0.014315m	-0.263303m
56	gpsds	PR 206	PR 052	-0.000774m	0.074304m
57	gpsaz	PR 206	PR 053	-63.103459"	-3.386483"
58	gpsht	PR 206	PR 053	0.513748m	-0.178852m
59	gpsds	PR 206	PR 053	-0.281539m	0.080682m
60	gpsaz	PR 304	PR 054	82.211724"	-3.385721"
61	gpsht	PR 304	PR 054	0.360103m	0.223656m
62	gpsds	PR 304	PR 054	-0.212375m	0.096682m
63	gpsaz	PR 304	PR 307	143.346314"	-3.386373"
64	gpsht	PR 304	PR 307	0.365187m	0.088764m
65	gpsds	PR 304	PR 307	-0.076830m	0.072159m
66	gpsaz	PR 304	PR 305	-8.057408"	-3.391576"
67	gpsht	PR 304	PR 305	-0.024288m	-0.026103m
68	gpsds	PR 304	PR 305	0.010223m	0.013164m
69	gpsaz	PR 304	PR 052	1.043459"	-3.393177"
70	gpsht	PR 304	PR 052	0.033355m	-0.073299m
71	gpsds	PR 304	PR 052	-0.003885m	0.040451m
72	gpsaz	PR 304	PR 053	-25.303768"	-3.386585"
73	gpsht	PR 304	PR 053	0.194341m	0.011146m
74	gpsds	PR 304	PR 053	0.059820m	0.065489m
75	gpsaz	PR 305	PR 052	-387.670687"	-3.392437"
76	gpsht	PR 305	PR 052	-0.531815m	-0.046754m
77	gpsds	PR 305	PR 052	-0.124618m	0.027313m
78	gpsaz	PR 305	PR 053	-4.999992"	-3.385844"
79	gpsht	PR 305	PR 053	-0.000846m	0.037693m
80	gpsds	PR 305	PR 053	0.058783m	0.077383m
81	gpsaz	PR 052	PR 053	-30.415742"	-3.384242"
82	gpsht	PR 052	PR 053	0.604050m	0.085161m
83	gpsds	PR 052	PR 053	-0.074914m	0.103621m
84	gpsaz	PR 053	PR 054	-8.818368"	-3.389982"
85	gpsht	PR 053	PR 054	0.058047m	0.212127m
86	gpsds	PR 053	PR 054	-0.052489m	0.055061m
87	gpsaz	PR 053	PR 307	-17.759856"	-3.390630"
88	gpsht	PR 053	PR 307	0.071354m	0.077236m
89	gpsds	PR 053	PR 307	-0.044400m	0.019765m
90	gpsaz	PR 307	PR 054	-6.772805"	-3.390188"
91	gpsht	PR 307	PR 054	-0.007872m	0.134036m
92	gpsds	PR 307	PR 054	-0.008292m	0.035398m
93	gpsaz	PR 209	PR 306	-18.062349"	-3.391626"
94	gpsht	PR 209	PR 306	-0.004563m	-0.062671m
95	gpsds	PR 209	PR 306	-0.004475m	0.019314m
96	gpsaz	PR 206	PR 054	1.623485"	-3.385611"
97	gpsht	PR 206	PR 054	0.023732m	0.033654m
98	gpsds	PR 206	PR 054	0.002826m	0.080868m
99	gpsaz	PR 209	PR 054	-10.545342"	-3.394912"
100	gpsht	PR 209	PR 054	-0.028778m	-0.156773m
101	gpsds	PR 209	PR 054	-0.048357m	0.073623m
102	gpsaz	PR 209	PR 053	-84.258567"	-3.395767"
103	gpsht	PR 209	PR 053	0.318341m	-0.369270m
104	gpsds	PR 209	PR 053	0.138867m	0.119357m
105	gpsaz	PR 306	PR 307	-0.276446"	-3.394771"
106	gpsht	PR 306	PR 307	-0.016458m	-0.231562m
107	gpsds	PR 306	PR 307	-0.009339m	0.083548m
108	gpsaz	PR 306	PR 054	-6.531868"	-3.394121"
109	gpsht	PR 306	PR 054	-0.022260m	-0.096678m
110	gpsds	PR 306	PR 054	-0.040994m	0.055759m

CLOSURES LOG (Continued)

<u>OBS#</u>	<u>TYPE</u>	<u>BACKSIGHT</u>	<u>FORESIGHT</u>	<u>CLOSURE</u>	<u>TRANSFORM</u>
111	gpsaz	PR 306	PR 053	-90.386796"	-3.394977"
112	gpsht	PR 306	PR 053	0.226543m	-0.309177m
113	gpsds	PR 306	PR 053	0.116914m	0.100033m
114	gpsaz	PR 054	PR 307	20.373552"	-3.391484"
115	gpsht	PR 054	PR 307	0.009310m	-0.136809m
116	gpsds	PR 054	PR 307	0.004738m	0.035406m
117	gpsaz	PR 054	PR 053	-119.268323"	-3.391690"
118	gpsht	PR 054	PR 053	0.268588m	-0.214424m
119	gpsds	PR 054	PR 053	0.344800m	0.055080m
120	gpsaz	PR 307	PR 053	-457.497609"	-3.391042"
121	gpsht	PR 307	PR 053	0.196910m	-0.078470m
122	gpsds	PR 307	PR 053	0.403539m	0.019768m
123	gpsaz	PR 211	PR 306	4.347293"	-3.397813"
124	gpsht	PR 211	PR 306	0.029054m	0.299146m
125	gpsds	PR 211	PR 306	0.009966m	0.131473m
126	gpsaz	PR 209	PR 307	-3.646539"	-3.395561"
127	gpsht	PR 209	PR 307	-0.021647m	-0.291657m
128	gpsds	PR 209	PR 307	-0.015411m	0.102740m
129	gpsaz	PR 211	PR 209	9.490985"	-3.397023"
130	gpsht	PR 211	PR 209	0.033904m	0.358618m
131	gpsds	PR 211	PR 209	0.213525m	0.131534m
132	gpsaz	PR 211	PR 210	-20.728997"	-3.389977"
133	gpsht	PR 211	PR 210	0.028398m	0.026161m
134	gpsds	PR 211	PR 210	0.019054m	0.015150m
135	gpsaz	PR 210	PR 303	53.463059"	-3.390187"
136	gpsht	PR 210	PR 303	-0.043272m	0.015632m
137	gpsds	PR 210	PR 303	-0.002995m	0.011081m
138	gpsaz	PR 210	PR 306	0.953194"	-3.398670"
139	gpsht	PR 210	PR 306	-0.005586m	0.269392m
140	gpsds	PR 210	PR 306	0.007454m	0.138704m
141	gpsaz	PR 210	PR 209	0.217473"	-3.397880"
142	gpsht	PR 210	PR 209	0.013922m	0.328864m
143	gpsds	PR 210	PR 209	0.022570m	0.136789m
144	gpsaz	PR 303	PR 306	1.819094"	-3.399319"
145	gpsht	PR 303	PR 306	0.028071m	0.250078m
146	gpsds	PR 303	PR 306	0.002240m	0.145324m
147	gpsaz	PR 306	PR 209	-17.212003"	-3.390045"
148	gpsht	PR 306	PR 209	0.007843m	0.056902m
149	gpsds	PR 306	PR 209	-0.003979m	0.019312m
150	gpsaz	PR 211	PR 303	-6.138769"	-3.389327"
151	gpsht	PR 211	PR 303	0.021417m	0.045389m
152	gpsds	PR 211	PR 303	0.008847m	0.026218m

**SUMMARY OF COVARIANCES
NETWORK = 01269
TIME = Tue Aug 20 13:09:55 2002**

Definition of precision $(E \times S) \hat{y} = C\hat{y} + P\hat{y}$:

- Horizontal:
 Precision (P) expressed as: ratio
 Propagated linear error (E): U.S.
 (standard error of adjusted horizontal distance)
 Scalar (S) on propagated linear error: 1.0000
 Constant error term (C): 0.0000
- 3-Dimensional:
 Precision (P) expressed as: ratio
 Propagated linear error (E): U.S.
 (standard error of adjusted slope distance)
 Scalar (S) on propagated linear error: 1.0000
 Constant error term (C): 0.0000
 Using orthometric height errors

This adjustment output file shows the precision of the 3D line vectors between each of the points in the network. Since 14 points were in this network (9 fixed and 5 new), a combination of 91 connecting lines are output ... only a selected few of which are shown in this tabulation. The precisions shown are from each point to every other point in the survey even if there wasn't a baseline measured between the points. This summary is used to show the precision even though the baselines were not measured and how the entire network fits relative to the 9 fixed control points.

FROM/ TO	AZIMUTH/ DELTA H	1.00σ 1.00σ	DISTANCE/ DELTA h	1.00σ 1.00σ	HOR PREC/ 3-D PREC
PR 052 PR 053	._*_ .*_	._*_ .*_	._*_ .*_	._*_ .*_	._*_ .*_
	+11.5998m	0.0292m	._*_ .*_	._*_ .*_	._*_ .*_
PR 052 PR 054	._*_ .*_	._*_ .*_	._*_ .*_	._*_ .*_	._*_ .*_
	+28.0013m	0.0395m	+27.8874m	0.0414m	._*_ .*_
PR 052 PR 204	._*_ .*_	._*_ .*_	._*_ .*_	._*_ .*_	._*_ .*_
	-3.4532m	0.0290m	._*_ .*_	._*_ .*_	._*_ .*_
•					
•					
•					
PR 052 PR 209	._*_ .*_	._*_ .*_	._*_ .*_	._*_ .*_	._*_ .*_
	+41.5643m	0.0307m	._*_ .*_	._*_ .*_	._*_ .*_
PR 052 PR 211	._*_ .*_	._*_ .*_	._*_ .*_	._*_ .*_	._*_ .*_
	+46.9522m	0.0294m	._*_ .*_	._*_ .*_	._*_ .*_
PR 052 PR 303	29ø16'46"	1.46"	3173.919m	0.0172m	1: 184743
	+46.7669m	0.0541m	+46.5919m	0.0547m	1: 184743
PR 052 PR 304	8ø54'01"	7.71"	430.678m	0.0158m	1: 27341
	+3.2057m	0.0535m	+3.1648m	0.0584m	1: 27341
•					
•					
PR 053 PR 303	31ø58'26"	2.25"	2077.146m	0.0170m	1: 122324
	+35.1671m	0.0539m	+35.0639m	0.0547m	1: 122324
PR 053 PR 304	213ø34'58"	5.08"	697.314m	0.0146m	1: 47849
	-8.3941m	0.0569m	-8.3632m	0.0584m	1: 47849
PR 053 PR 305	209ø02'33"	2.34"	823.967m	0.0086m	1: 96335
	-8.7670m	0.0481m	-8.7264m	0.0509m	1: 96335

Precision between two fixed points

PR 054 "h" not held fixed

1-s azimuth accuracy

1-s distance accuracy

Precision ratio

Precision between fixed points and new points

1-s ortho elev accuracy

(a total of 91 precisions are output ... all similar to the above examples)

OBSERVATION ADJUSTMENT SUMMARY
NETWORK = 01269
TIME = Tue Aug 20 13:09:55 2002

OBSERVATION ADJUSTMENT (Tau = 3.50)

GPS Parameter Group 1 GPS Observations

Azimuth rotation = +3.3908 seconds 1.00σ = 1.2360 seconds
Deflection in latitude = -45.7925 seconds 1.00σ = 6.9026 seconds
Deflection in longitude = -62.5723 seconds 1.00σ = 7.5689 seconds
Network scale = 0.999906082080 1.00σ = 0.000005772833

This is the adjustment summary of all of the control that was used in this survey. The points have a difference in the geoid, horizontal and vertical observations that were performed in this survey based on the geoid model that was used to adjust the observation data from the RINEX files.

OBS#	BLK#/ REF#	TYPE	BACKSIGHT/ INSTRUMENT/ FORESIGHT	UDVC/ UDPG/ RESIDUAL	OBSERVED/ ADJUSTED/ 1.00σ	1.00σ/ TAU
1	1	hgoid	***- ***- PR 052 ***- ***- 1	-41.4304m -41.4421m -0.011729m	0.0223m 0.0207m 0.0084m	0.40
2	2	hgoid	***- ***- PR 053 ***- ***- 1	-41.3676m -41.3703m -0.002726m	0.0223m 0.0214m 0.0065m	0.12
3	3	hgoid	***- ***- PR 054 ***- ***- 1	-41.3282m -41.3282m +0.000000m	0.0223m 0.0223m 0.0000m	OPEN
4	4	hgoid	***- ***- PR 204 ***- ***- 1	-41.4381m -41.4353m +0.002743m	0.0223m 0.0213m 0.0065m	0.12
5	5	hgoid	***- ***- PR 205 ***- ***- 1	-41.4248m -41.4236m +0.001185m	0.0223m 0.0212m 0.0070m	0.05
6	6	hgoid	***- ***- PR 206 ***- ***- 1	-41.3735m -41.3591m +0.014451m	0.0223m 0.0192m 0.0114m	0.36
7	7	hgoid	***- ***- PR 209 ***- ***- 1	-41.2740m -41.2838m -0.009748m	0.0223m 0.0213m 0.0067m	0.42
8	8	hgoid	***- ***- PR 210 ***- ***- 1	-41.2747m -41.2728m +0.001904m	0.0223m 0.0211m 0.0072m	0.08
9	9	hgoid	***- ***- PR 211 ***- ***- 1	-41.2858m -41.2819m +0.003920m	0.0223m 0.0212m 0.0070m	0.16
10	10	hgoid	***- ***- PR 303 ***- ***- 1	-41.2671m -41.2671m +0.000000m	0.0223m 0.0223m 0.0000m	OPEN

OBSERVATION ADJUSTMENT SUMMARY (Continued)

OBS# BLK#/ TYPE BACKSIGHT/ UDVC/ OBSERVED/ 1.00σ/ TAU
REF# INSTRUMENT/ UDPG/ ADJUSTED/ 1.00σ/
FORESIGHT SBNT RESIDUAL 1.00σ

11 -**- hgoid -**- -**- -41.4013m 0.0223m OPEN
11 PR 304 -**- -41.4013m 0.0223m
-**- 1 +0.000000m 0.0000m

12 -**- hgoid -**- -**- -41.4110m 0.0223m OPEN
12 PR 305 -**- -41.4110m 0.0223m
-**- 1 +0.000000m 0.0000m

13 -**- hgoid -**- -**- -41.2891m 0.0223m OPEN
13 PR 306 -**- -41.2891m 0.0223m
-**- 1 +0.000000m 0.0000m

14 -**- hgoid -**- -**- -41.3539m 0.0223m OPEN
14 PR 307 -**- -41.3539m 0.0223m
-**- 1 +0.000000m 0.0000m

15 1 gpsaz -**- -**- 172ø34'03.2773" 5.7761" 0.04
1 PR 206 -**- 172ø34'02.5786" 1.2360"
PR 204 1 -0.698700" 5.6423"

16 1 gpsht -**- -**- -63.3097m 0.0807m 0.02
1 PR 206 -**- -63.3058m 0.0370m
PR 204 1 +0.003973m 0.0717m

17 1 gpsds -**- -**- 886.2649m 0.0238m 0.71
1 PR 206 -**- 886.3225m 0.0051m
PR 204 1 +0.057609m 0.0233m

18 2 gpsaz -**- -**- 136ø08'10.5143" 7.3927" 0.07
1 PR 206 -**- 136ø08'12.1008" 3.1584"
PR 305 1 +1.586500" 6.6841"

19 2 gpsht -**- -**- -57.0105m 0.0777m 0.10
1 PR 206 -**- -57.0322m 0.0461m
PR 305 1 -0.021643m 0.0625m

20 2 gpsds -**- -**- 584.9467m 0.0261m 0.08
1 PR 206 -**- 584.9531m 0.0099m
PR 209 1 -0.003979m 0.0133m

-
-
-
-

**Observations 21 thru 149 similar
(#39, 40, 41 excluded)**

150 46 gpsaz -**- -**- 8ø13'20.3253" 19.3844" 0.15
1 PR 211 -**- 8ø13'14.1866" 15.1696"
PR 303 1 -6.138768" 12.0680"

151 46 gpsht -**- -**- -0.2522m 0.0570m 0.19
1 PR 211 -**- -0.2308m 0.0470m
PR 303 1 +0.021417m 0.0323m

152 46 gpsds -**- -**- 279.1379m 0.0253m 0.15
1 PR 211 -**- 279.1468m 0.0192m
PR 303 1 +0.008847m 0.0164m

Azimuth (gpsaz)

Height (gpsht)

Distance (gpsds)

ADJUSTMENT STATISTICS SUMMARY

NETWORK = 01269
TIME = Tue Aug 20 13:09:54 2002

ADJUSTMENT SUMMARY

Network Reference Factor = 1.00
Chi-Square Test ($\sigma = 95\%$) = PASS
Degrees of Freedom = 115.00

Degrees of Freedom =
No. of obs - no. of unk = 149-34 = 115

GPS OBSERVATIONS

Reference Factor = 1.00
r = 114.04

GPS Solution 1	Reference Factor = 1.51	r = 2.69	GPS Solution 24	Reference Factor = 0.73	r = 2.88
GPS Solution 2	Reference Factor = 0.31	r = 2.31	GPS Solution 25	Reference Factor = 0.66	r = 2.76
GPS Solution 3	Reference Factor = 0.44	r = 2.71	GPS Solution 26	Reference Factor = 0.49	r = 2.43
GPS Solution 4	Reference Factor = 0.96	r = 2.45	GPS Solution 27	Reference Factor = 1.07	r = 1.89
GPS Solution 5	Reference Factor = 1.77	r = 2.41	GPS Solution 28	Reference Factor = 0.26	r = 2.56
GPS Solution 6	Reference Factor = 0.65	r = 2.36	GPS Solution 29	Reference Factor = 2.30	r = 2.56
GPS Solution 7	Reference Factor = 0.51	r = 2.92	GPS Solution 30	Reference Factor = 0.28	r = 2.99
GPS Solution 8	Reference Factor = 2.20	r = 2.95	GPS Solution 31	Reference Factor = 0.39	r = 2.11
<u>GPS Solution 9</u>	<u>Reference Factor = 1.00</u>	<u>r = 0.00 *</u>	GPS Solution 32	Reference Factor = 1.97	r = 2.20
GPS Solution 10	Reference Factor = 0.57	r = 2.72	GPS Solution 33	Reference Factor = 0.15	r = 2.99
GPS Solution 11	Reference Factor = 0.58	r = 2.34	GPS Solution 34	Reference Factor = 1.72	r = 2.06
GPS Solution 12	Reference Factor = 0.13	r = 1.92	GPS Solution 35	Reference Factor = 0.20	r = 2.99
GPS Solution 13	Reference Factor = 3.08	r = 2.91	GPS Solution 36	Reference Factor = 0.22	r = 2.99
GPS Solution 14	Reference Factor = 0.16	r = 2.81	GPS Solution 37	Reference Factor = 1.11	r = 2.25
GPS Solution 15	Reference Factor = 0.40	r = 3.00	GPS Solution 38	Reference Factor = 1.01	r = 2.13
GPS Solution 16	Reference Factor = 0.26	r = 2.99	GPS Solution 39	Reference Factor = 0.10	r = 2.99
GPS Solution 17	Reference Factor = 0.25	r = 2.99	GPS Solution 40	Reference Factor = 1.17	r = 2.90
GPS Solution 18	Reference Factor = 0.42	r = 1.63	GPS Solution 41	Reference Factor = 0.15	r = 2.82
GPS Solution 19	Reference Factor = 0.34	r = 2.01	GPS Solution 42	Reference Factor = 0.13	r = 2.75
GPS Solution 20	Reference Factor = 0.19	r = 3.00	GPS Solution 43	Reference Factor = 0.80	r = 2.11
GPS Solution 21	Reference Factor = 0.51	r = 2.99	GPS Solution 44	Reference Factor = 0.44	r = 1.67
GPS Solution 22	Reference Factor = 0.95	r = 2.56	GPS Solution 45	Reference Factor = 0.75	r = 2.24
GPS Solution 23	Reference Factor = 0.31	r = 3.00	GPS Solution 46	Reference Factor = 0.53	r = 1.10

* excluded baseline

EM 1110-1-1003
1 Jul 03

GEOID MODEL

Reference Factor = 1.00 r = 0.96

Geoid Heights: Reference Factor = 1.00 r = 0.96

Delta Geoid Heights: Reference Factor = 1.00 r = 0.00

WEIGHTING STRATEGIES:

GPS OBSERVATIONS:

Scalar Weighting Strategy:

Alternative Scalar Set Applied Globally = 30.04

No summation weighting strategy was used

Station Error Strategy:

H.I. error = 0.0030

Tribrach error = 0.0030

GEOID MODEL:

Scalar Weighting Strategy:

Alternative Scalar Set Applied Globally = 0.36

No summation weighting strategy was used

Results of adjusted Geoid model:

Noise in vertical GPS observations: 0.31669041

Variance of geoid model: 0.00049794

Further use of correlated Geoid Model not recommended

****** Adjusted Coordinates ******

Projection Group: NAD-83 SP Lambert

Zone Name: P.R. and V.I.

Linear Units: meter

Angular Units: degrees

Datum Name: NAD-83

Station Short Name	North	East	Ortho. Height
PR 052	215011.48020	232319.57730	33.89900
PR 053	216017.89600	232771.92300	45.42700
PR 054	216466.56900	232394.40000	61.85600
PR 204	214840.36000	232081.21800	30.43900
PR 205	214972.45600	231867.18900	30.96500
PR 206	215719.31600	231966.53799	93.89700
PR 209	217248.07400	232454.47800	75.30500
PR 210	217663.82000	233850.78100	79.55900
PR 211	217503.61100	233831.92799	80.69100
PR 303	217779.91745	233871.84091	80.47200
PR 304	215436.97244	232386.20863	37.04600
PR 305	215297.53496	232371.91574	36.72700
PR 306	217049.36699	232507.43018	68.77300
PR 307	216167.62873	232624.01503	50.46767



***** End of Report *****

[See Figure I-16 for screen capture view of the adjusted points]

I-4. Adjustment Output Plots

Horizontal and elevation errors are graphically depicted, as shown in Figures I-13 and I-14 below. Figure I-13 contains fixed points, so no error ellipses are generated. Station PR 054 was held fixed in position but not in elevation; thus, the elevation and height standard errors are shown.

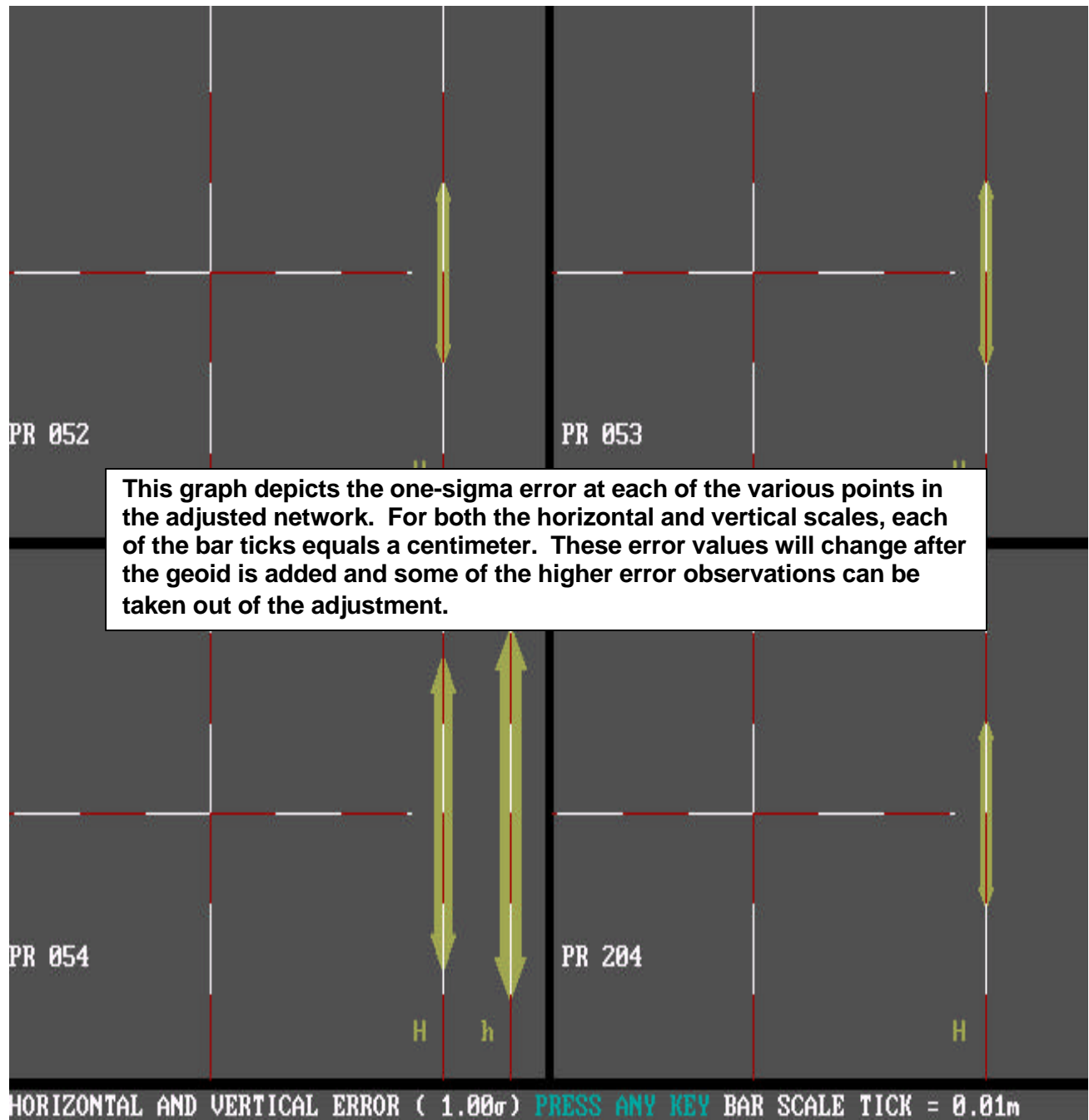

Figure I-13. Trimble GPSurvey positional error plots

This GPSurvey output graph shows one-sigma error ellipses and scales for some selected new points in the adjustment. Displays should be set to depict 95% accuracies instead of one-sigma values.

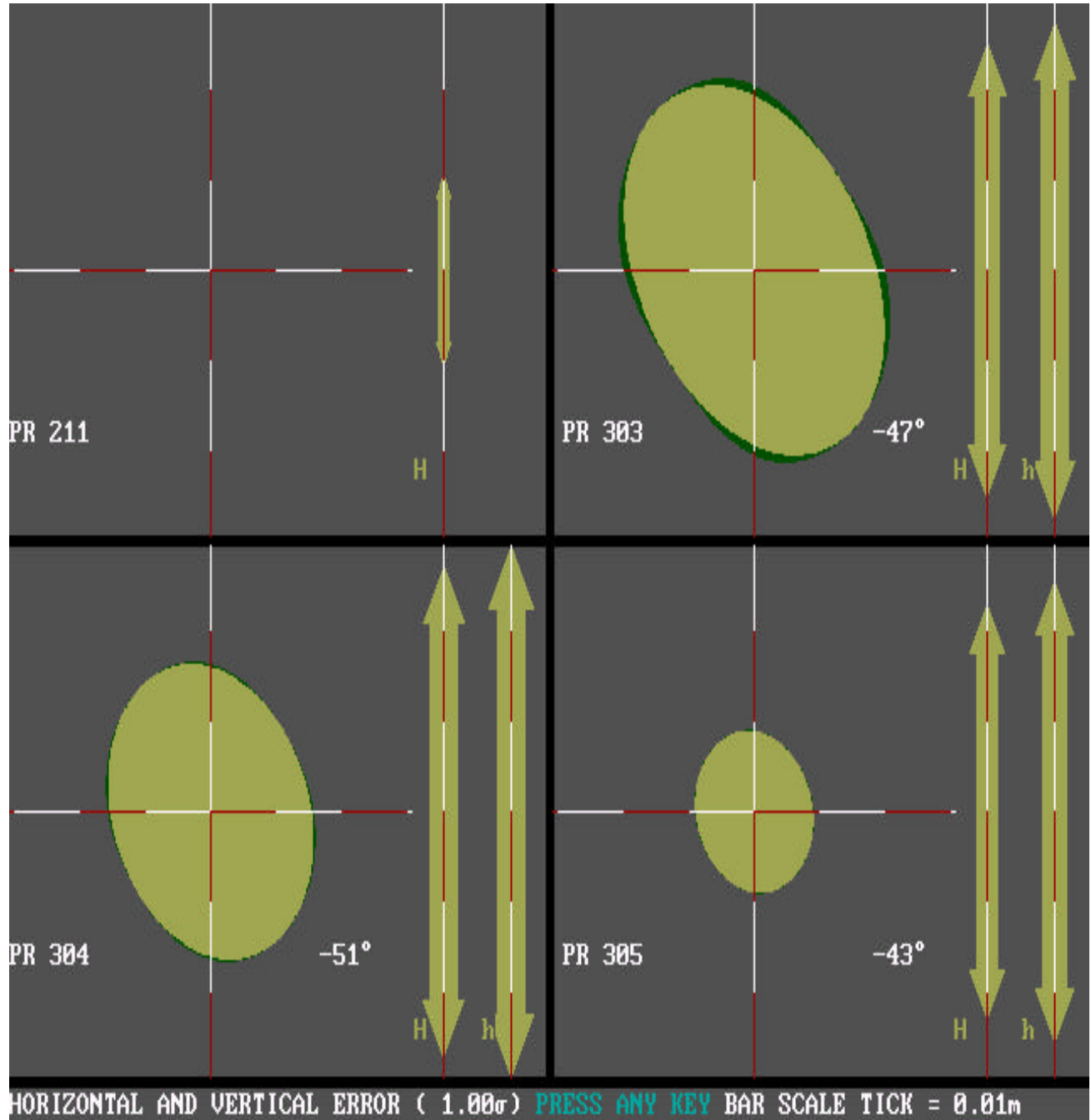

Figure I-14. Trimble GPSurvey positional error ellipses at adjusted points

The following screen capture (Figure I-15) of the adjustment output shows a histogram of the network's standardized (or normalized) residuals. The top figure shows the histogram for combined horizontal and vertical residuals. These residual plots should resemble a bell curve, as is apparent. A rough evaluation of potential outliers can be observed by noting residuals falling outside the 3-sigma level. As can be seen below, a few observations are outside the 3-sigma level, but none exceed 4-sigma.

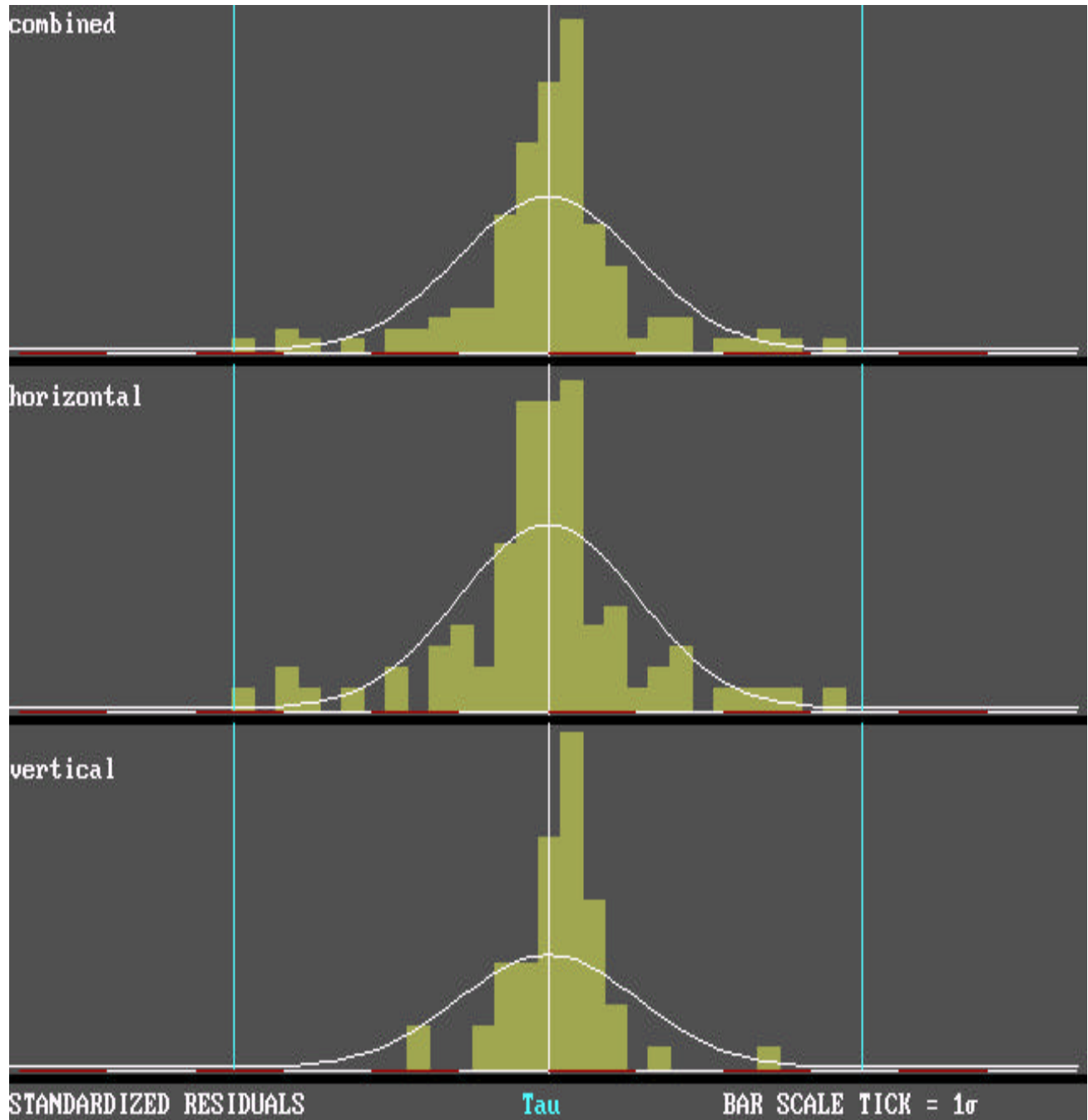

Figure I-15. Trimble GPSurvey Standardized Residual histograms

Figure I-16 is a screen capture of the adjusted coordinates.

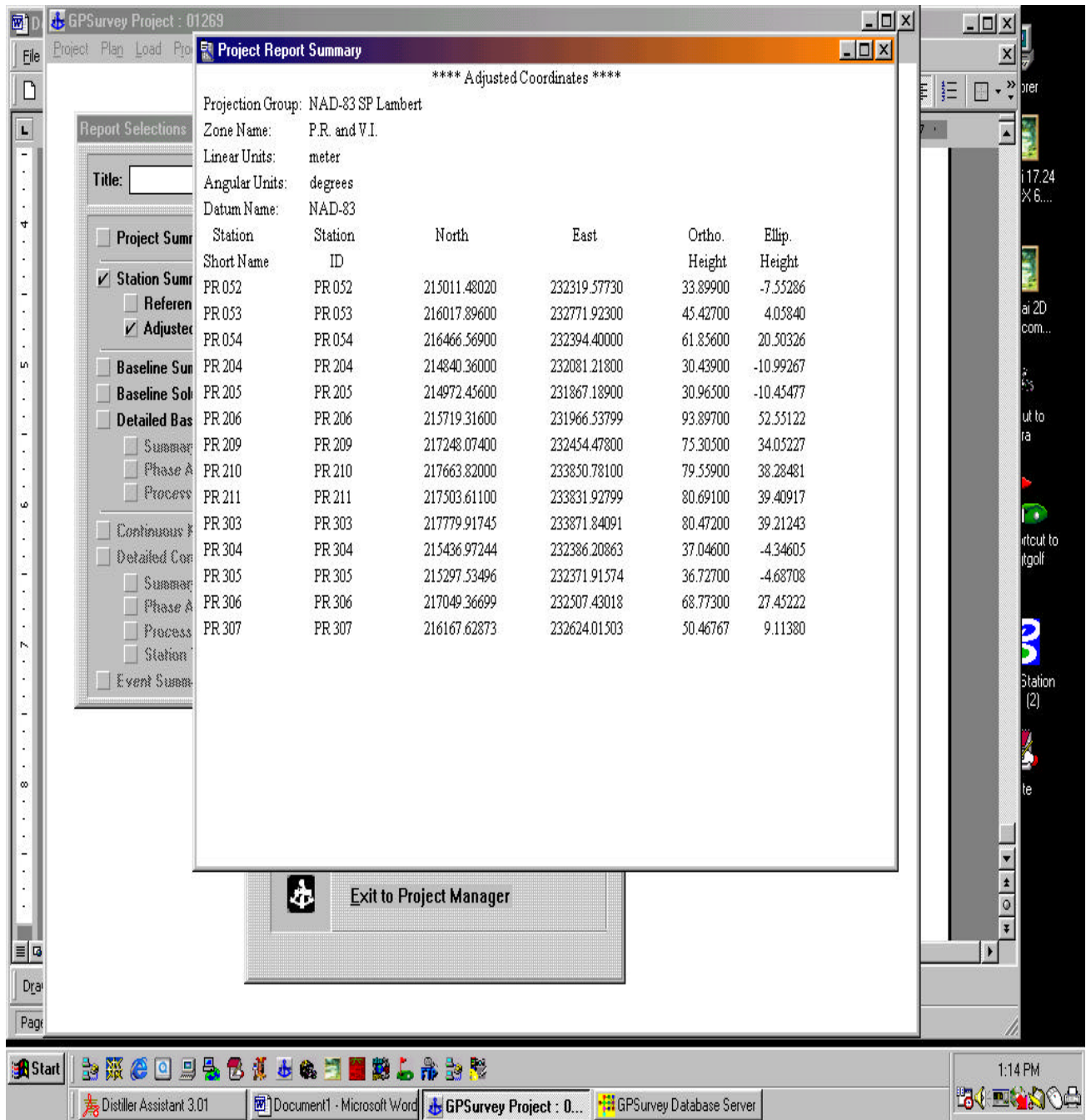

Figure I-16. Trimble GPSurvey listing of adjusted coordinates

Appendix J

Application: Upland Disposal Area GPS Control Survey--Manatee Harbor, FL (Jacksonville District)

GPS Survey Report for Manatee Harbor Upland Disposal Area Static Control Survey

Project: Manatee Harbor Upland Disposal, Plans and Specifications Scope Survey,
Manatee Harbor, Manatee County, FL

Project No.: USACOE – 01-260, Foresight Surveyors, Inc. – 11058

Purpose: To verify and / or establish horizontal coordinates for the upland disposal site control.

Date for Work Done : October, 2001

Equipment Used: Trimble 4700 / 5700 Dual Frequency GPS Receivers in Static mode.

2 - 4700 (Part No. 35846-56): Serial No. 0220137053 0220137059

2 - 5700 (Part No. 40406-46): Serial No. 0220240528 0220240619

Control Points Used:

Horizontal Pts.: NGS and Manatee Co., M 006, M 007, M 009, M 011, and Gillette. (all are First Order Horizontal control points)

Vertical Pts.: US Army Corps Survey Points MAN MN H 0002, MAN MN H 0004, MAN MN H 0014, MAN MN H 0015, MAN MN H 0016, MAN MN H 0018, MAN MN H 0019, and JEG FLDNR 092 all of which are Second Order Vertical control points.

* Please see file 01-260Cntrl.doc for control point descriptions sheets.

Horizontal Datum / Projection Used: All coordinates are based on the 1983 North American Datum (83/86 adjustment), Florida West Zone (0902) of the State Plane Coordinate projection system. The units are U. S. Feet.

Vertical Datum Used: NGVD 1929, with the units being Feet.

Static Data Collection: All static data was collected using the following parameters:

Epoch logging rate: 15 sec.
Minimum logging time: 1 hr.
Elev. Mask of: 13 deg.
Minimum No. of Satellites: 5

Each static session utilized four (4) Trimble dual frequency GPS receivers collecting at least one hour of raw data simultaneously. The sessions were planned using independent baselines in order to build a geometrically strong and complete network. This network has a minimum of three baseline ties for each of the thirteen points observed. For any sessions which required (because of logistics) the same receiver to repeat a session at the same point, the tripod / antenna setup would be broken down and re-setup.

Static Data Collection Cont:

No adverse types of weather conditions occurred during the days of data collection. The days were clear with higher numbers of satellites during the daylight hours. Overall the data collection phase of the network went well.

GPS Antenna Height Measurements :

4700 Antenna

The two Trimble 4700 GPS receivers used the Trimble Microcentered L1/L2 GPS antennas with Ground Planes (Part No. 33429-00) set on standard land surveying tripods with optical tribrachs. The antenna height for these two 4700 setups was measured using the Trimble, screw together, GPS Antenna HI Rod. Three measurements were taken around the sides of the antenna to give an average height from the top center of the monument to the bottom of the notch, at the outside of the ground plane (See R2 in diagram below). The three measurements were taken each time the antenna was setup.

Trimble Micro Centered L1/L2 GPS Antenna with Ground Plane (Part No. 33429-20)

	Dimensions		Descriptions
A	0.205 ft.	0.0625 m.	Bottom of antenna mount to Nominal Phase Center
B	0.011 ft.	0.0034 m.	Top of ground plane to Nominal Phase Center
C	0.022 ft.	0.0069 m.	Bottom of ground plane to Nominal Phase Center
R1	0.766 ft.	0.2334 m.	Radius to inside of ground plane notch
R2	0.792 ft.	0.2413 m.	Radius to outside of ground plane

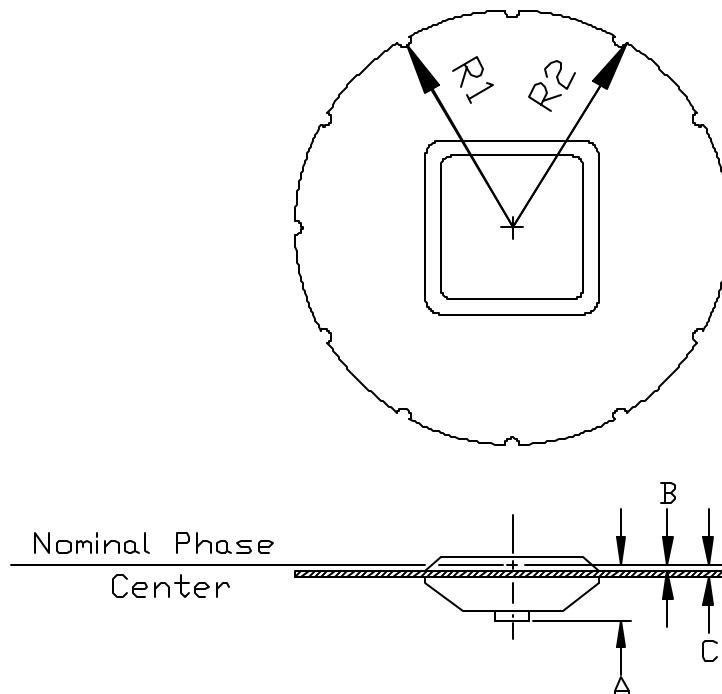

GPS Antenna Height Measurements Cont.:

Antenna / Tripod Setup for 4700 Receivers with Micro Centered L1/L2 Antenna

* Measurements were to the “outside, bottom of the ground plane notch”

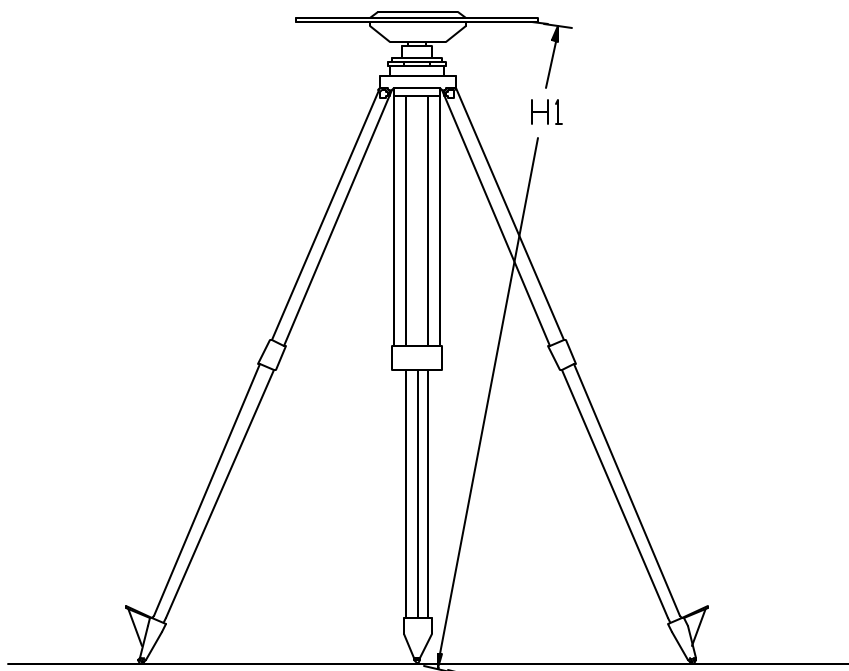

GPS Antenna Height Measurements Cont.:

5700 Antennas

The two 5700 receivers used the Trimble Zephyr GPS antennas. One had the Zephyr Geodetic (Base) antenna (Part No. 41249-00), which has a built in ground plane. The other receiver used the Zephyr (Rover) antenna (Part No. 39105-00) and it does not have a geodetic ground plane. Both receivers used 2.0 meter fixed height tripods and height measurements were from the top, center of the monument, to the bottom of the antenna mount. Using the fixed height tripod gave us a true height (not uncorrected) of 2.0m to the bottom of the antenna mount.

**5700 Base Receiver using the Zephyr Antenna with Ground Plane:
(Receiver Serial No. 0220240619)**

* See diagram below.

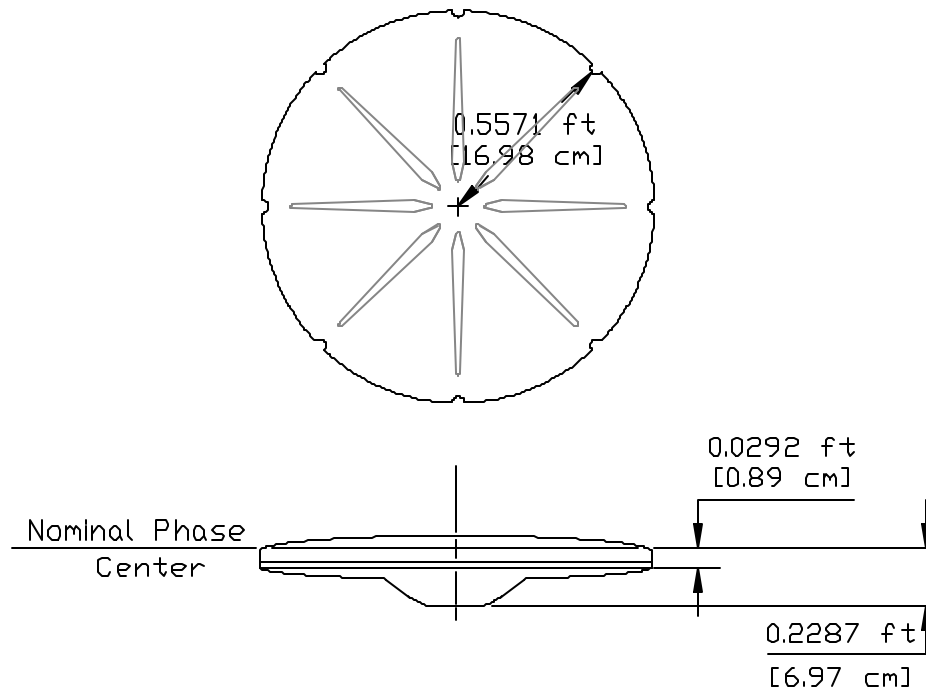

GPS Antenna Height Measurements Cont.:

Antenna/Tripod Setup for 5700 Base Receiver with Zephyr Antenna (with Ground Plane)

* This setup used a 2.0 meter fixed height tripod.

* Antenna height measurement was to the “bottom of the antenna mount”.

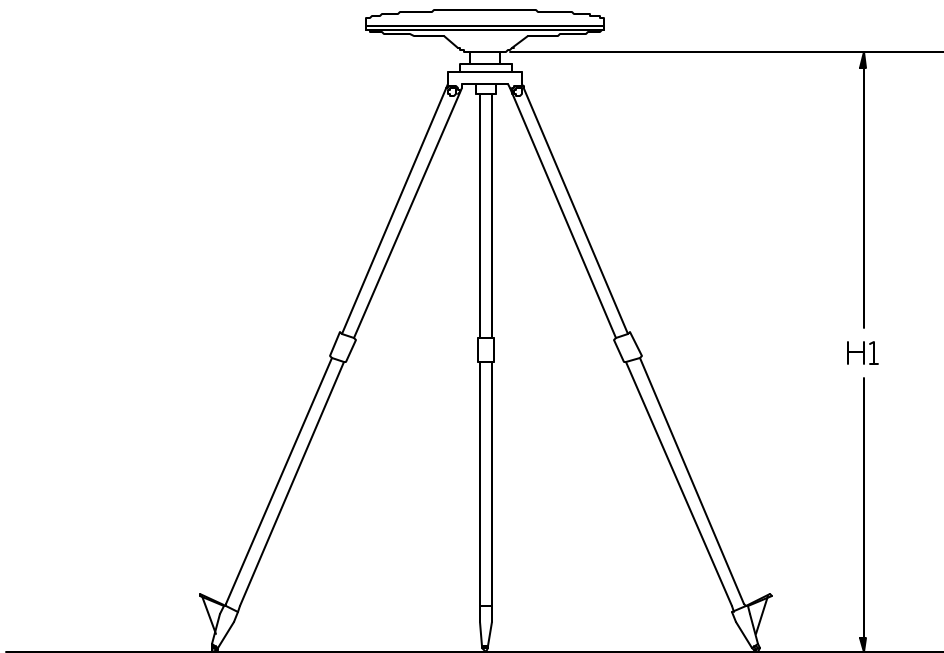

GPS Antenna Height Measurements Cont.:

**5700 Rover Receiver using the Zephyr Antenna without Ground Plane:
(Receiver Serial No. 0220240528)**

* See diagram below.

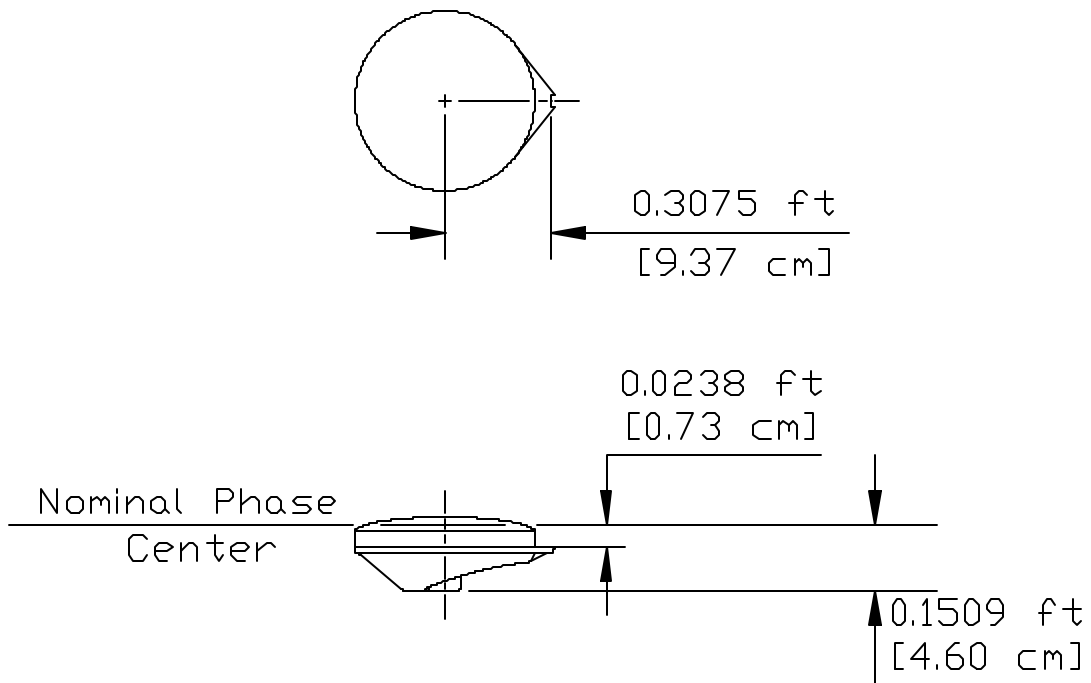

GPS Antenna Height Measurements Cont.:

Antenna/Tripod Setup for 5700 Rover Receiver, Zephyr Antenna (without Ground Plane)

* This setup used a 2.0 meter fixed height tripod.

* Antenna height measurement was to the “bottom of the antenna mount”.

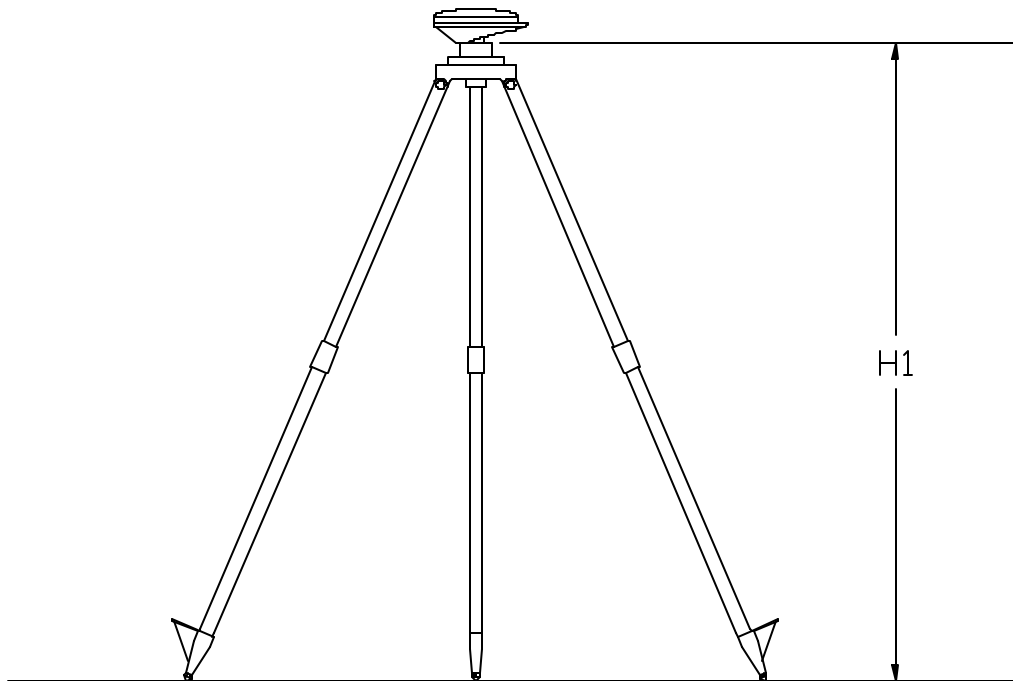

Baseline Processing and Adjustment: The post-processing was performed using Trimble's baseline processing software, Trimble Geomatics Office (TGO). The network configuration was built in TGO by selecting certain independent baselines. Once the baselines had been chosen and the known points had been "coordinate seeded", then the processing began. The network consisted of 5 known horizontal (First Order) points, 6 known vertical (Second Order) points, and 8 unknown points on which coordinates were established.

Network:

- 13 points (4 pts as "unknowns")
- 30 baselines
 - Longest baseline: 16064.1 US Ft.
 - Shortest baseline: 858.2 US Ft.
 - Average baseline: 7724.2 US Ft.

Network Configuration:

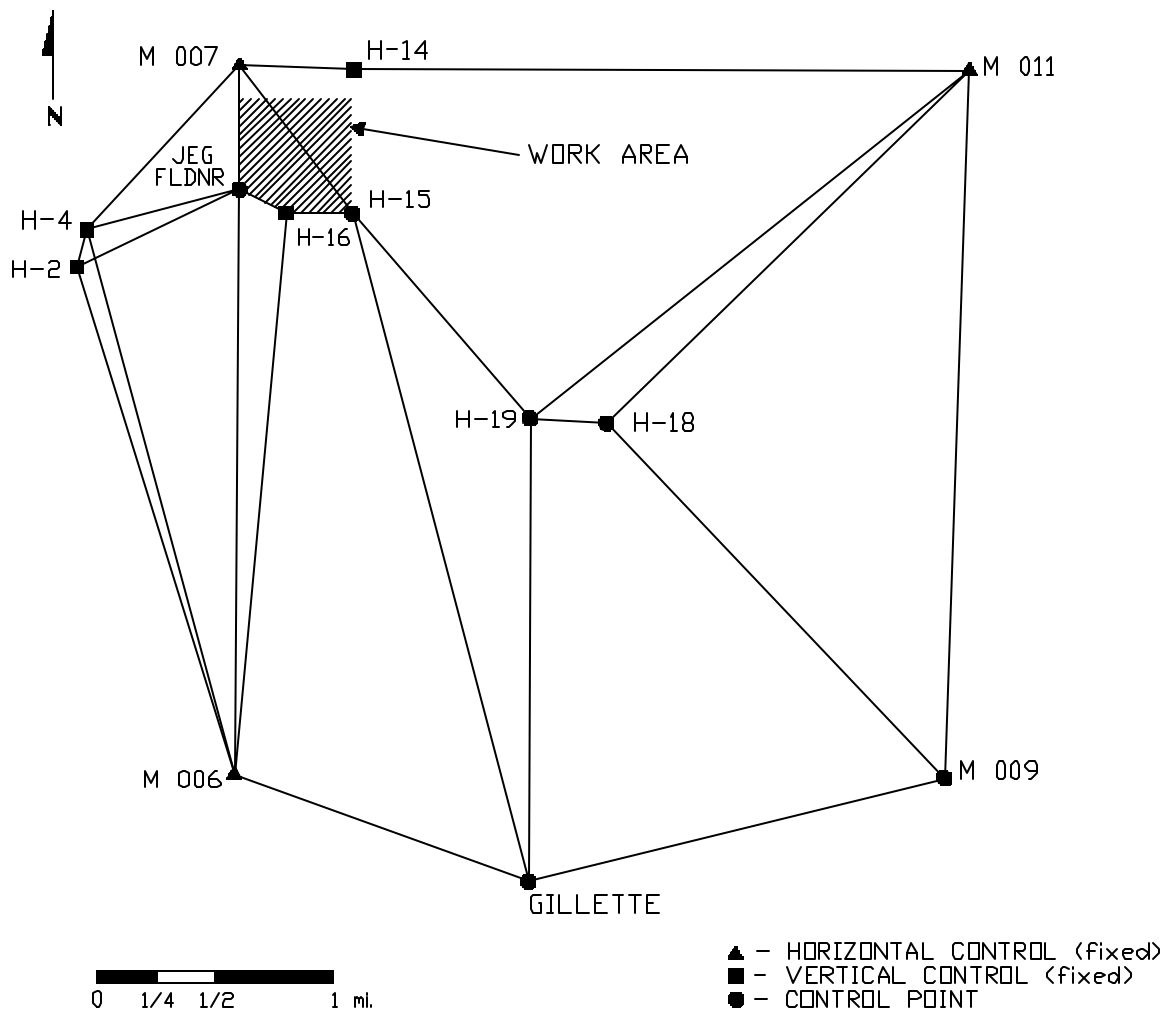

Baseline Processing and Network Adjustment Cont.

- * For complete results please see the subdirectory 01260\Report\Final, which contains files:
 - GPS Vector Data.htm
 - BLSummary.html
 - Recompute Report.htm

The least squares adjustment procedure initially applied the proper amounts of weighting to account for the systematic and random errors, minimally constrained the network, then progressively held control points for the best fit overall. The points held fixed are listed below.

Horizontal Pts Held Fixed: NGS and Manatee Co., M 006, M 007, and M 011.

Horizontal Check Points: Gillette and M 009.

Vertical Pts Held Fixed: US Corps Survey Pts: MAN MN H 0002, MAN MN H 0004, MAN MN H 0014, MAN MN H 0016.

Vertical Check Points: MN MAN H 0015, MN MAN H 0018, MN MAN H 0019.

Again, the purpose of the network was to confirm the horizontal control being used and to establish NAD 83/86 coordinates on those surrounding control points. The network tied in well between the NGS points, but showed a difference with the given NAD 27 State Plane Coordinate values for points H-14, H-15, and H-16. The average difference between the known values and the static values was an average of N = 1.372 ft and E = 2.596 ft. The resulting values for the three control points (H-14, H-15, H-16) were different from the existing values, but consistent in the amount and direction that each of the points varied. The network results can be seen by viewing the point comparison chart on the next page and by viewing the listed files below.

Baseline Processing and Network Adjustment Cont.

Comparison of Known vs. Established Coords. for Port Manatee Disposal Area (11058, 01-260)

* Differences are Known values - GPS established values in US Ft.

Pt. No.	Northing	Easting	Elev.	Description	Control Use	Diff. N.	Diff. E.	Diff. El.
	1204123.388	481367.520	6.22	MN MAN H 0014	Fixed Cntrl (V)			
14	1204122.023	481365.022	6.22	H-14 GPS		1.365	2.498	0.00
	1200858.621	481330.503	10.06	MN MAN H 0015	Cntrl Check (V)			
15	1200857.194	481327.865	10.10	H-15 GPS		1.427	2.638	-0.04
	1200877.643	479829.576	8.34	MN MAN H 0016	Fixed Cntrl (V)			
16	1200876.318	479826.925	8.34	H-16 GPS		1.325	2.651	0.00
	1204223.158	478775.329	3.00	M 007	Fixed Cntrl (H)			
17	1204223.159	478775.329	3.67	M 007 GPS		-0.001	0.000	-0.67
			6.09	JEG FLDNR	Extra Cntrl			
18	1201407.569	478755.971	6.09	JEG FLDNR GPS				0.00
	1185702.573	485334.530	36.90	GILLETTE	Cntrl Check (H)			
20	1185702.566	485334.577	36.23	GILLETTE GPS		0.007	-0.047	0.67
	1199658.676	475077.876	7.93	MN MAN H 0002	Fixed Cntrl (V)			
21	1199657.705	475075.060	7.93	H-2 GPS		0.971	2.816	0.00
	1200489.510	475293.340	8.70	MN MAN H 0004	Fixed Cntrl (V)			
22	1200488.395	475290.494	8.70	H-4 GPS		1.115	2.846	0.00
	1196102.473	487107.435	27.06	MN MAN H 0018	Extra Cntrl			
23	1196102.242	487105.881	26.81	H-18 GPS		0.231	1.554	0.25
	1196217.929	485367.492	18.92	MN MAN H 0019	Extra Cntrl			
24	1196217.498	485365.950	18.63	H-19 GPS		0.431	1.542	0.30
	1188126.786	478648.027	4.00	M 006	Fixed Cntrl (H)			
25	1188126.787	478648.027	3.26	M 006 GPS		-0.001	0.000	0.75
	1188044.468	494781.041	27.00	M 009	Cntrl Check (H)			
26	1188044.478	494781.032	27.51	M 009 GPS		-0.010	0.009	-0.51
	1204097.907	495355.333	20.00	M 011	Fixed Cntrl (H)			
27	1204097.907	495355.333	21.13	M 011 GPS		0.000	0.000	-1.13

Results are also listed in the subdirectory 01260\Report\Final, which contains files:
 Network Adjustment Report.html
 Loopclosure.html
 PtCompare.xls

Baseline Processing and Network Adjustment Cont.

The resulting coordinates are being given in two different forms: Latitude, Longitude, and Ellipsoid Height (NAD 83/86, US Feet), as well as State Plane Coordinates (NAD 83/86, Florida West Zone (0902), US Feet).

Horiz Datum: NAD 83 (86)
Vert. Datum: Ellipsoid Height, Feet

Pt. Name	Latitude	Longitude	Height	Description
14	27 38 42.94971 N	82 32 23.78105 W	-74.10	MN MAN H 0014
15	27 38 10.61915 N	82 32 24.03548 W	-70.21	MN MAN H 0015
16	27 38 10.74326 N	82 32 40.72479 W	-71.94	MN MAN H 0016
17	27 38 43.83820 N	82 32 52.58217 W	-76.61	M 007
18	27 38 15.95690 N	82 32 52.65850 W	-74.18	JEG FLDNR
20	27 35 40.72588 N	82 31 38.76784 W	-44.82	GILLETTE
21	27 37 58.46608 N	82 33 33.49749 W	-72.27	MN MAN H 0002
22	27 38 06.70136 N	82 33 31.14401 W	-71.51	MN MAN H 0004
23	27 37 23.78053 N	82 31 19.56840 W	-53.56	MN MAN H 0018
24	27 37 24.84864 N	82 31 38.91726 W	-61.72	MN MAN H 0019
25	27 36 04.44314 N	82 32 53.20380 W	-76.95	M 006
26	27 36 04.30391 N	82 29 53.87980 W	-52.93	M 009
27	27 38 43.29243 N	82 29 48.21374 W	-59.41	M 011

Horiz Datum / Proj :NAD 83 (86), SPC FL West Zone (0902), US Feet
Vert. Datum: NGVD 1929, Feet (from network)

Pt. Name	Northing	Easting	Elev.	Description
14	1204122.023	481365.022	6.22	MN MAN H 0014
15	1200857.194	481327.865	10.10	MN MAN H 0015
16	1200876.318	479826.925	8.34	MN MAN H 0016
17	1204223.158	478775.329	3.67	M 007
18	1201407.569	478755.971	6.08	JEG FLDNR
20	1185702.573	485334.530	36.23	GILLETTE
21	1199657.705	475075.060	7.93	MN MAN H 0002
22	1200488.395	475290.494	8.70	MN MAN H 0004
23	1196102.242	487105.881	26.82	MN MAN H 0018
24	1196217.498	485365.950	18.62	MN MAN H 0019
25	1188126.786	478648.027	3.25	M 006
26	1188044.468	494781.041	27.51	M 009
27	1204097.907	495355.333	21.13	M 011

Coordinates can also be found in the subdirectory 01260\Report\Final, which contains files:
01-260LLH.doc
01-260NEE.doc

End of Report

Glossary

Absolute Positioning

The unique ability of a GPS receiver to produce positional values without another receiver for reference.

Ambiguity

The unknown number of whole carrier wavelengths between the satellite and the receiver. Also called **cycle ambiguity**.

Anywhere Fix

Receiver with unique ability to calculate positions without being given an approximate location and time.

Antispoofing (A/S)

An encryption technique developed by the US Department of Defense (DoD) that when implemented, denies access to the P-code by any unauthorized users. With antispoofing on, the user will need a DoD-issued "key" in order to gain access to the P-code.

Apogee

The point in the orbit of a satellite about the earth that is the greatest distance from the center of the earth.

Autocorrelation

In reference to code, a plot of the scalar product of the noise sequence with a delayed copy of itself.

Bandwidth

A measure of the width of the frequency spectrum of a signal expressed in Hertz.

Baseline

The resultant three-dimensional vector V between any two stations from which simultaneous GPS data have been collected and processed. Generally given in earth-centered Cartesian coordinates where:

$$V = (D_x, D_y, D_z)$$

Beat Frequency

Either of the two additional frequencies obtained when two signals of two frequencies are mixed, equal to the sum or difference of the original frequencies.

Binary Pulse Code Modulation

A two-state pulse modulation using a string of binary numbers or codes. The coding is generally represented by 1 and 0 with definite meanings attached to each.

Binary Biphase Modulation

Phase changes on a constant frequency carrier of either 0 or 180 degrees. These represent the binary digits 0 and 1, respectively.

Binary Code

A system used in communication where selected strings of 0's and 1's are assigned definite meanings.

Broadcast Ephemeris

The ephemeris broadcast by the GPS satellites.

Canadian National Convention (CNT)

The Canadian standard transformation program for converting between NAD 27 and NAD 83. Accuracy is often in the range of 0.10 meter and it predicts to within 0.50 meter for 93 percents of all cases.

C/A-Code

The standard Course/Acquisition GPS code, sometimes referred to as the Clear Access Code, also known as the S- or Standard Code. This code contains a sequence of 1023 pseudo-random binary biphasic modulations on the GPS carrier at a chipping rate of 1.023 MHz, thus having a period of 1 ms.

Carrier

A high-frequency radio wave having at least one characteristic (frequency, amplitude, or phase) which may be varied by modulation from an accepted value. In general, the carrier wavelength is much shorter than the wavelength of the codes.

Carrier Beat Phase

The difference between the phase of the incoming Doppler shifted satellite carrier signal and the phase of the nominally constant reference frequency generated in the receiver.

Carrier Phase

The phase measurement of the carrier wave. The percentage value is usually converted to millimeters.

Carrier Frequency

The frequency of the unmodulated fundamental output of a radio transmitter.

Cartesian/Geocentric Coordinates

A system of defining position which has its origin at the center of the earth with the x- and y-axes in the plane of the equator. Typically, the x-axis passes through the meridian of Greenwich, and the z-axis coincides with the earth's axis of rotation. The three axes are mutually orthogonal and form a right-handed system.

Channel

A channel of a GPS receiver consists of the hardware and the software to track the signal from one satellite at one of the two carrier frequencies.

Chip

a. The minimum transition time interval for individual bits of either a 0 or a 1 in a binary pulse code, usually transmitted in a pseudo-random sequence. b. A tiny square piece of thin semiconductor material on which an integrated circuit is formed or to be formed.

Clock Bias

Difference between clock's indicated time and true universal time.

Code

A system for representing information, together with rules for using the system.

Code Receiver

An instrument that requires a knowledge of the P- or C/A-code to complete its measurements. This type of receiver will also record the broadcast ephemeris.

Codeless Receiver

An instrument that does not require a knowledge of the P- or C/A-codes to perform measurements. This type of receiver does not record any ephemeris data. Therefore, before a baseline solution is computed, an ephemeris file must be obtained from another source.

Collimate

To physically align a survey target or antenna over a mark.

Complete Instantaneous Phase Measurement

A measurement of carrier beat phase which includes the integer number of cycles of phase since the initial measurement. See *Fractional Instantaneous Phase Measurement; Integer-cycle Ambiguity*.

Control Points

A point to which coordinates have been assigned. These coordinates can then be held fixed and are used in other dependent surveys.

Control Segment

A worldwide network of GPS monitoring and control stations that ensure the accuracy of the GPS satellite orbits and operations of their atomic clocks. The original control segment consists of control facilities in Diego Garcia, Ascension Island, Kwajalein, and Hawaii, with a master control station at the Consolidated Space Operations Center (CSPOC) at Colorado Springs, Colorado.

Correlation Type Channel

A channel that uses a correlator to maintain alignment between a receiver generated code and/or carrier frequency and the incoming satellite code and/or carrier frequency.

Cycle Ambiguity

See **Ambiguity**.

Cycle Slip

A discontinuity in measured carrier beat phase resulting from a temporary loss of lock in the carrier tracking loop of a GPS receiver.

D-code (Data Message)

A 1500-bit message included in the GPS signal which reports the satellite's location, clock corrections, and health. Included is rough information on the other satellites in the constellation.

Datum

A horizontal or vertical reference system for making survey measurements and computations. A set parameters and control points used to accurately define the three-dimensional shape of the earth. The datum defines parts of a geographic coordinate system that is the basis for a planar coordinate system. Horizontal datums are typically referred to ellipsoids, the State Plane Coordinate System, or the Universal Transverse Mercator Grid System. Vertical datums are typically referred to the geoid. The vertical datum used in the United States is the National Geodetic Vertical Datum of 1929 (NGVD 29), formerly referred to as the Sea Level Datum of 1929. This datum has been upgraded to the North American Vertical Datum of 1988 (NAVD 88).

Datum transformation, geographic transformation

A method that converts data between two geographic coordinate systems (datum).

Deflection of the Vertical

The angle between the perpendicular to the geoid (plumb line) and the perpendicular to an ellipsoid.

Delay Lock

A code correlation technique where the code received from a satellite is compared with "early" and "late" versions of the reference code generated by the receiver to obtain a bipolar discrimination function.

DSARC

Defense System Acquisition Review Council, the DoD body which must authorize any major defense system acquisition.

Delta Pseudo-range

See *Reconstructed Carrier Phase*.

Differencing

A technique used in baseline processing to resolve the integer cycle ambiguity and to reduce a number of error sources including oscillator variations and atmospheric and orbital modeling errors. This technique "differences" the measurement of the carrier beat phase across time, frequency, receivers, satellites, or any combination of these. The most popular differences are described below:

A **single difference** between receivers is the instantaneous difference in the complete carrier beat phase measurements made at two receivers simultaneously observing the same signal.

A **double difference** between receivers and between satellites is found by differencing the single difference for one satellite with the single difference for another satellite where both single differences are from the same epoch.

A **triple difference** between receivers, between satellites, and between epochs (time) is the difference between a double difference at one epoch and the same double difference at the following epoch.

Differential Positioning

The determination of the position of an object station relative to a reference station when receivers at each station are simultaneously tracking the same signals.

Dilution of Precision (DOP)

A measure of the geometric contribution to the uncertainty of a position fix. The more popular terms are given below:

GDOP - Geometric Dilution of Precision - measurement accuracy in three-dimensional position and time.

PDOP - Position Dilution of Precision (PDOP) - measurement accuracy in three-dimensional position.

HDOP - Horizontal Dilution of Precision (HDOP) - measurement accuracy in two-dimensional horizontal position.

VDOP - Vertical Dilution of Precision (VDOP) - measurement accuracy as standard deviation of vertical height.

RDOP - Relative Dilution of Precision (RDOP) - measurement of the quality of baseline reductions.

Doppler-aiding

Signal processing strategy that uses a measured Doppler shift to help the receiver smoothly track the GPS signal, allowing more precise velocity and position measurement.

Doppler Shift

The apparent change in frequency of a received signal due to the rate of change of the distance between the transmitter and receiver.

Dynamic Positioning

Determination of the position of a moving receiver such as one mounted in a boat. Generally, each set of coordinates is computed from a single data sample. The GPS was originally conceived for dynamic positioning of a single receiver; however, it may be used in a differential mode to increase relative accuracy. Also, referred to as **kinematic positioning**.

Eccentricity

The ratio of the distance from the center of an ellipse to its focus on the semi-major axis.

Elevation

The height of an object above some reference datum.

Ellipsoid

A geometric shape formed by revolving an ellipse about its minor axis. The term is used interchangeably with spheroid. An ellipsoid is defined by the length of its semi-major axis a and its flattening f , where:

$$f = (a - b)/a$$

and b = length of the semi-minor axis.

The most commonly used ellipsoids in North America are:

- Clarke 1866
- Geodetic Reference System of 1980 (GRS 80)
- World Geodetic System of 1972 (WGS 72)
- World Geodetic System of 1984 (WGS 84)

Prior to January 1987, the GPS operated with reference to WGS 72. Since January 1987, it has been referenced to WGS 84. For most purposes, the GRS 80 and WGS 84 can be considered identical.

Ellipsoid Height

The elevation h of a point above or below the ellipsoid.

Ephemeris

A tabular statement of the positions of a celestial body (satellite) at regular intervals.

Epoch

A period of time or a date selected as a point of reference.

Fast Switching Channel

A switching channel with a time sequence short enough to recover the integer part of the carrier beat phase. The switching time is generally between 2 to 5 ms.

EM 1110-1-1003
1 Jul 03

Flattening
See **Ellipsoid**.

Fractional Instantaneous Phase Measurement

A measurement of the carrier beat phase that does not include any integer cycle count.

Frequency Band

A range of frequencies in a region of the electromagnetic spectrum.

Frequency Spectrum

The distribution of signal amplitudes as a function of frequency of the constituent signal waves.

Fundamental Frequency

The GPS fundamental frequency F is 10.23 MHz. The carrier frequencies are:

$$L1 = 154 * F = 1575.42 \text{ MHz}$$

$$L2 = 120 * F = 1227.60 \text{ MHz}$$

Geographic coordinates

A measurement of a location of the earth's surface expressed in degrees of latitude and longitude. See also projected coordinates.

Geoid

An equipotential surface approximating the earth's surface and corresponding with mean sea level in the oceans and its extension through the continents. In other words, the geoid would coincide with the surface to which the oceans would conform over the entire earth if the oceans were set free to adjust to the combined effect of the earth's mass attraction and the centrifugal force of the earth's rotation.

Geodetic Leveling Network

A network of vertical control or benchmarks whose heights are known as accurately as possible, and whose horizontal position are known only approximately.

Geoid Height

The elevation N of the geoid above or below the reference ellipsoid.

GPS

Global Positioning System. The GPS consists of the NAVSTAR satellites in six different orbits, five monitor stations, and the user community.

GPS Time

The broadcast GPS time signals are synchronized with atomic clocks at the GPS Master Control Station. These clocks are in turn periodically synchronized with Coordinated Universal Time (UTC). However, UTC is incremented by "leap seconds" to correct for the slowing of the earth's rotation with respect to the sun; GPS time is not. As of July 1990:

$$\text{GPS time} = \text{UTC} + 4 \text{ seconds}$$

The fundamental time scale for all the earth's timekeeping is International Atomic Time (TAI). It is a continuous time scale not corrected by "leap seconds." There is a constant offset of 10 seconds between GPS time and TAI such that:

$$\text{GPS time} = \text{TAI} - 10 \text{ seconds}$$

Handover Word

The word in the GPS message that contains time synchronization information for the transfer from the C/A-code to the P-code.

Horizontal Geodetic Network

A network for which the horizontal coordinate, latitude, and longitude of the control points in the network are determined as accurately as possible, and heights are known only approximately.

Independent Baseline

Those baselines that provide a unique position solution for a given station.

INS

Inertial Navigation System, which contains an Inertial Measurement Unit (IMU).

Integer-cycle Ambiguity

The unknown integer number of whole carrier cycles between the satellite and receiver.

Integrated Doppler

The accumulation of measured Doppler frequency multiplied by the time interval of measurement, so as to approximate the integral over time of the Doppler frequency.

Interferometry

See **Differential Positioning**.

Ionosphere

Region of the earth's atmosphere between the stratosphere and the exosphere approximately 50 to 250 miles above the surface of the earth.

Ionospheric Refraction Delay

A delay in the propagation of the GPS signal caused by the signal traveling through the ionosphere.

IRON

Inter Range Operation Number. A random number assigned to various orbiting objects assigned by the joint US/Canadian North American Air Defense Command (NORAD). Each of the GPS satellites has an individual IRON.

JPO

GPS Joint Program Office, originally located at the US Air Force Space Division at El Segundo, California. The JPO consists of the US Air Force Program Manager and Deputy Program Managers representing the Army, Navy, Marine Corps, Coast Guard, Defense Mapping Agency, and NATO.

Kinematic Positioning

Often used to describe **dynamic positioning**. A GPS differential surveying technique, whereby one GPS unit, the fixed receiver, stays fixed on a known control point, while another GPS unit, the rover, collects data on a constantly moving vehicle, all the time continually tracking four or more satellites during the observation period. This process is done in an effort to ascertain the location or position of the rover receiver.

L-band

The radio frequency band from 390 MHz to 1550 MHz. The primary L-band signal radiated by each NAVSTAR satellite is L1 at 1575.42 MHz. The L1 beacon is modulated with the C/A- and P-codes, and with the NAV message. L2 is centered at 1227.50 MHz.

L1

See **L-band**.

L2

See **L-band**.

Lock

The state of noninterruption in the reception of a radio signal.

Monitor Station

One of five worldwide stations maintained by the DoD and used in the GPS control segment to monitor and control satellite clock and orbital parameters. Corrections are calculated and uploaded to each satellite at least once per day. See **Control Segment**.

Multipath

A phenomenon similar to "ghosts" on a television screen whereby GPS signals from a satellite arrive at an antenna having traversed different paths. The signal traversing the longer path may have been reflected off one or more objects--the ground, a vehicle, boat, building or some other surface--and once received by the antenna, will yield a larger pseudo-range estimate and increase the error. Multipath usually results in **multipath error**.

Multipath Error

A positioning error resulting from radio signals traveling from the transmitter to the receiver by two paths of different electrical lengths.

Multichannel Receiver

A receiver containing multiple channels.

Multiplexing Channel

A receiver channel that is sequenced through a number of satellite signals, each from a specific satellite.

NAD 27

The North American Datum of 1927 uses the Clarke 1866 spheroid to represent the shape of the earth. The origin of this datum is a point on the earth referred to as Meades Ranch in Kansas. Many NAD 1927 control points were calculated from observations taken in the 1800. These calculations were done manually and in sections over many years. Therefore, errors vary from station to station.

NAD 83

Many technological advances in surveying and geodesy since the establishment of NAD 27--electronics theodolites, GPS satellites, very Long Baseline Interferometry, and Doppler systems--revealed weaknesses in the existing network of control points. Differences became particularly noticeable when linking existing control with newly established surveys. To address these problems, the North American Datum of 1983 was developed. It consistently covers North America and surrounding areas and is based upon both earth and satellite observations using the GRS 80 spheroid. The origin for this datum is the earth's center of mass rather than the point on the earth (as with NAD 27), which causes the locations of previous control points in North America to shift, sometimes as much as 500 feet. A 10-year multinational effort

ties together a network of control points for the United States, Canada, Mexico, Greenland, Central America, and the Caribbean. Because NAD 83 is an earth-centered coordinate system, it is compatible with GPS data. The raw GPS data is actually reported in the World Geodetic System 1984 (WGS 1984) coordinate system.

NADCON (North American Datum CONversion)

The standard NAD 27-NAD 83 datum transformations program, created by the United States National Geodetic Survey. Transformation is derived from a minimum curvature surface from the National Geodetic Reference System. Approximate accuracy of 0.15-0.50 meter. NADCON is the fastest, simplest, and most accurate datum transformation for mapping at scale of 1:200 and smaller and is intended for conversion of NAD 27 to NAD 83 in the continental United States, Puerto Rico, and the Virgin Islands.

NAV Data

The 1500-bit NAVigation message broadcast by each satellite at 50 bps on both L1 or L2 beacons. This message contains system time, clock correction parameters, ionospheric delay model parameters, and the vehicle's ephemeris and health. This information is used to process GPS signal to obtain user position and velocity. Sometimes referred to as the **Navigation message**.

Navigation Message

See **NAV data**.

NAVSTAR

NAVSTAR is the name given to GPS satellites, originally manufactured by Rockwell International.

Observing Session

The period of time over which data are collected.

Orthometric Height

The elevation H of a point above or below the geoid. A relationship between ellipsoid heights and orthometric heights is obtained from the following equation:

$$h = H + N$$

where

h = ellipsoidal height

H = orthometric height

N = geoidal height

Outage

The period of time when a Dilution of Precision exceeds a specified maximum.

Precise or Protected Code (P-Code)

A sequence of pseudo-random binary biphasic modulations on the GPS carrier at a chip rate of 10.23 MHz which repeats once every 267 days. Each 1-week segment of code is unique to a particular GPS satellite and is generally reset each week.

Perigee

The point in the orbit of a satellite about the earth that is the least distant from the center of the earth.

Phase Lock

The technique where the phase of a signal is set to replicate the phase of a reference signal by comparing the phase of the two signals and then using the resultant phase difference to adjust the reference oscillator to eliminate the difference.

Phase Measurement

A measurement expressed as a percentage of a portion of a wave (e.g., a sine wave). For example, a complete wavelength is 100 percent; one-half is 50 percent; etc.

Phase Observable

See **Reconstructed Carrier Phase**.

Polar Plot

A circular plot in which elevation and azimuth as a function of time for each satellite, with respect to a specified location, are predicted and plotted.

Positioning

Determination of a position (usually a GPS antenna) with respect to a coordinate system (WGS 84, UTM, State Plane, etc.).

Precise Ephemeris

The ephemeris computed after the transmission of the satellite signal and based on satellite tracking information.

Precise Positioning Service (PPS)

Dynamic positioning of a single receiver based on the P-code. Currently, the PPS is the most accurate dynamic positioning service offered with GPS.

Projected coordinates

A measurement of locations on the earth's surface in a two-dimensional system that locates features based on their distance from an origin (0,0) along two axes, a horizontal *x*-axis representing east-west and a vertical *y*-axis representing north-south. A map projection transforms latitude and longitude to *x,y* coordinates in a projected coordinate system. See also geographic coordinates.

Projected coordinate system

1. A reference system used to measured horizontal and vertical distances of a planimetric map. A coordinate system is usually define by a map projection, a spheroid of references, a datum, one or more standard parallels, a central meridian, and possible shifts in the *x*-and *y*-directions to locate *x,y* positions of points, line, and area features.
2. In ArcInfo, a system with units and characteristics defined by a map projection. A common coordinate system is used to spatially register geographic data for a given area.
3. A reference system consisting of a set of points, lines and/or surfaces and a set of rules used to define the position of points in space either in two or three dimensions.

Projection

A mathematical formula that transforms feature locations between the earth's curved surface and a map's flat surface. A projected coordinate system includes the information needed to transform locations expressed as latitude values to x,y coordinates. Projections cause distortion in one or more of these spatial properties-distance, area, shape, and direction.

Pseudolite

A ground-based GPS station that can be used in a ranging solution. The station transmits a signal with a structure similar to that of an actual GPS satellite.

Pseudo-Random Noise (PRN)

When used as a description of code, it indicates that the code has some random noise-like properties. Each GPS satellite has a unique PRN number assigned to it.

Pseudorange

The time shift required to align a replica of the GPS code generated in the receiver with the code received from the satellite, scaled into distance by the speed of light. The time shift is the difference between the time of signal reception and the time of signal transmission where the reception is measured in the receiver time reference and the transmission is measured in the satellite time reference. Therefore, the pseudo-range contains several errors including satellite/receiver time offset, and satellite ephemeris error.

Pseudorange Difference

See **Reconstructed Carrier Phase**.

Pseudorange Observable

The difference between the time of transmission and the time of arrival of a particular signal transmitted by the satellite.

Reconstructed Carrier Phase

The difference between the incoming Doppler-shifted carrier phase and the phase of a nominally constant reference frequency generated in the receiver. In dynamic applications, the reconstructed carrier phase is sampled at epochs of the received message code, and the difference in reconstructed carrier phase between consecutive code epochs is a measure of the change in satellite-to-receiver range between epochs. This is referred to as the pseudo-range difference, or the delta pseudo-range. In static positioning, the reconstructed carrier phase is sampled at epochs determined by the receiver clock. The reconstructed carrier phase changes according to the continuously integrated Doppler shift of the incoming signal, biased by the integral of the frequency offset between the satellite and receiver oscillators. The reconstructed carrier phase can be referred to the range between satellite and receiver once the phase ambiguity has been resolved. One cycle change in the reconstructed carrier phase is one wavelength of the carrier signal change in the range from satellite to receiver.

Relative Positioning

See **Differential Positioning**.

S-Code

Another name for the C/A-Code.

Satellite Constellation

The arrangement of a set of satellites in space.

Satellite Message

Sometimes, referred to as the Data (D) code. A low-frequency (50 Hz) stream of data on both carriers (L1 and L2) of the satellite signal. The stream of data is designed to inform the user about the health and position of the satellite. The satellite message can be decoded by the receiver and used for positioning in real time.

Selective Availability (S/A)

The policy of the DoD to intentionally degrade the accuracy obtainable from GPS by civilian users.

Simultaneous Measurements

A measurement or set of measurements referred to the same epoch.

Slow Switching Channel

A channel that switches with a period too long to recover the integer part of the carrier phase.

Space Segment

The portion of the GPS system with major components in space (e.g., GPS satellites).

Spheroid

Used interchangeably with **ellipsoid**.

Squaring-type channel

A receiver channel that multiplies the received signal by itself to obtain a second harmonic of the carrier which does not contain the code modulation.

Standard Positioning Service (SPS)

Positioning of a single receiver based on the C/A-Code. Also see **PPS**.

Static Positioning

Determination of the position of a stationary receiver.

Stop-and-Go Kinematic Surveying

A GPS differential survey technique whereby one GPS unit, the fixed receiver, remains fixed on a known control point, while the other, a rover receiver, collects signals on a point of unknown position for a short period of time, usually minutes, and then moves to subsequent points to collect signals for a few more minutes, all the time continually tracking four or more satellites during the observation period. This process is done in an effort to ascertain the position of the object stations occupied by the rover receiver.

Switching Channel

A channel that is sequenced through a number of satellite signals at a rate that is slower than and asynchronous with the message data rate.

Time Tag

The time appended to an actual measurement.

Translocation

See **Differential Positioning**.

Troposphere

Inner layer of the atmosphere, located between 6 and 12 miles above the earth's surface.

User Equivalent Range Error (UERE)

A term for GPS measurement accuracy which represents the combined effects of ephemeris uncertainties, propagation errors, clock and timing errors, and receiver noise. A high UERE may indicate that S/A has been imposed on the satellite used.

User Segment

The portion of the GPS with major components that can be directly interfaced by the user (e.g., GPS receivers).

Visibility Plot

A plot against time of day of the number of satellites which are visible from a specified location.

Y-code

The P-code after encryption.

Z-count Word

The GPS satellite clock time at the leading edge of the data subframe of the transmitted GPS message.